

**Einbauanleitung Elektrosatz
Anhängervorrichtung mit 12-N Steckdose
lt. DIN/ISO Norm 1724**

**Instructions de montage du faisceau
électrique pour crochet d'attelage
conforme à la norme
DIN/ISO 1724 prise 12-N**

**Fitting instructions electric wiringkit
towbar with 12-N socket up to
DIN/ISO norm 1724**

**Montage-handleiding elektrokabelset voor
trekhaak met 12-N contactdoos
vlgs. DIN/ISO norm 1724**

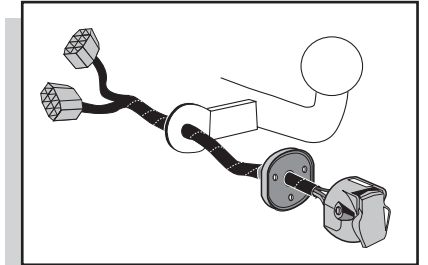

**SUZUKI WAGON R+ 2000-
OPEL AGILA 2000-**

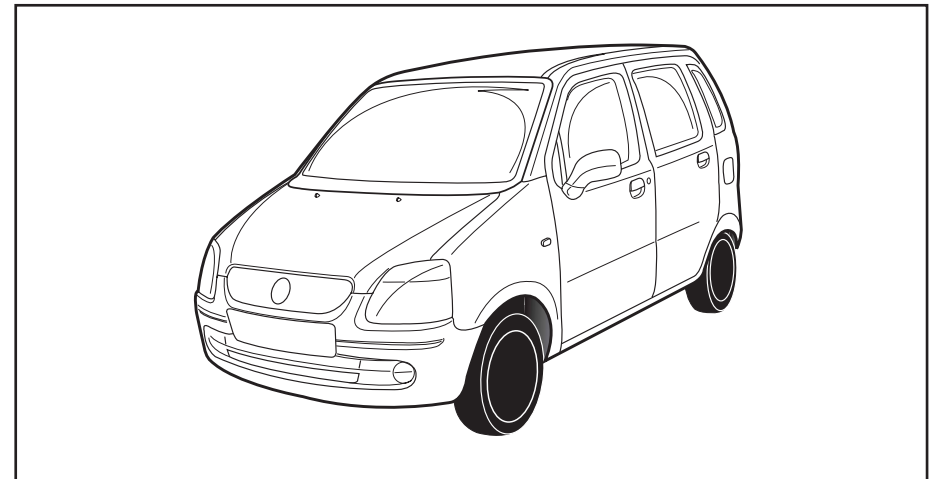

Bestel Nr.: SZ-008-BB

* Teilliste

* Liste de pieces

* Part list

* Onderdelenlijst

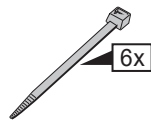
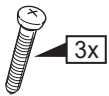
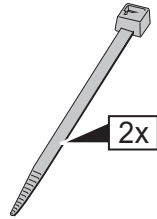
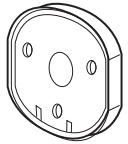
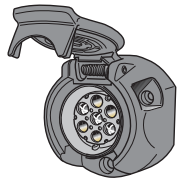
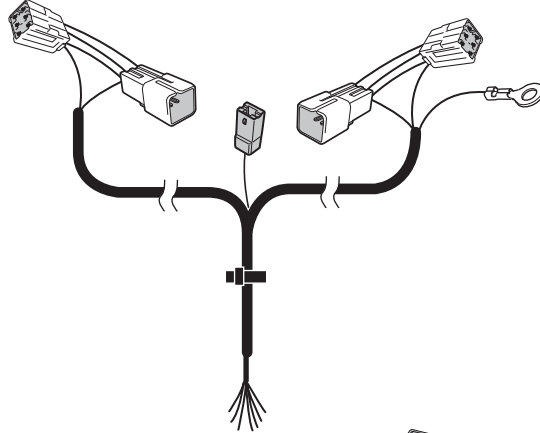
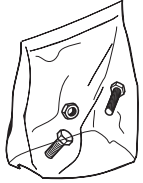
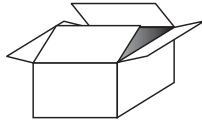

10

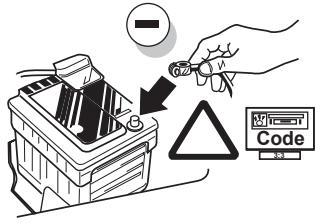

11

! FUNKTIONEN KONTROLLIEREN !
! CONTRÔLER LES FONCTIONS !
! CHECK FUNCTIONS !
! CONTROLEER FUNCTIES !

1

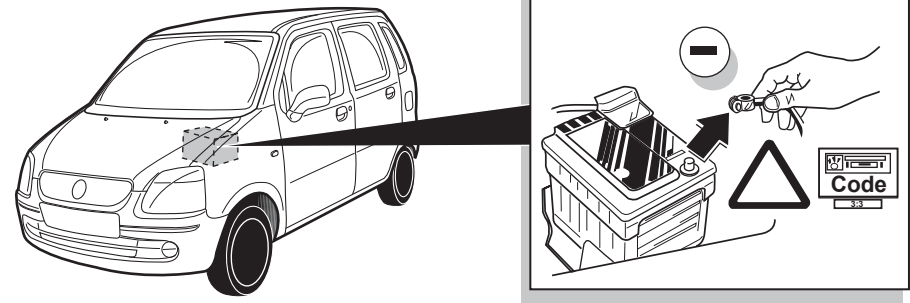

12

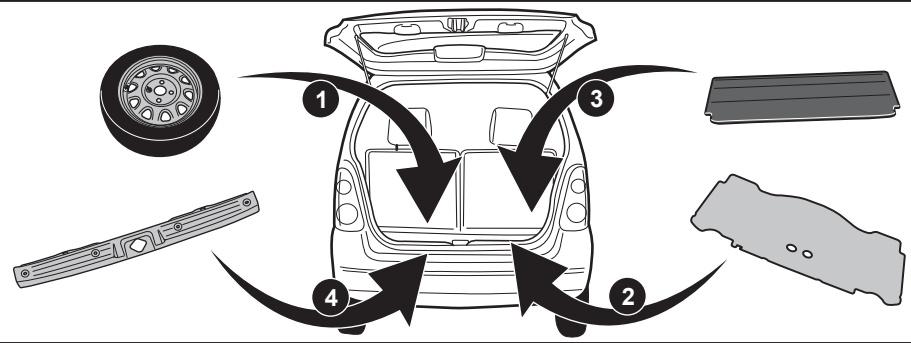

2

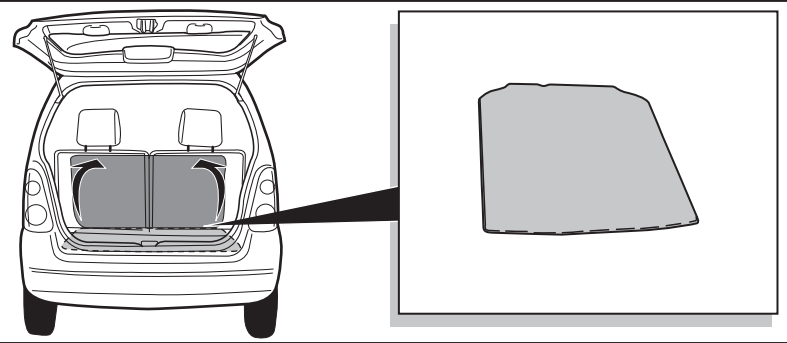

13

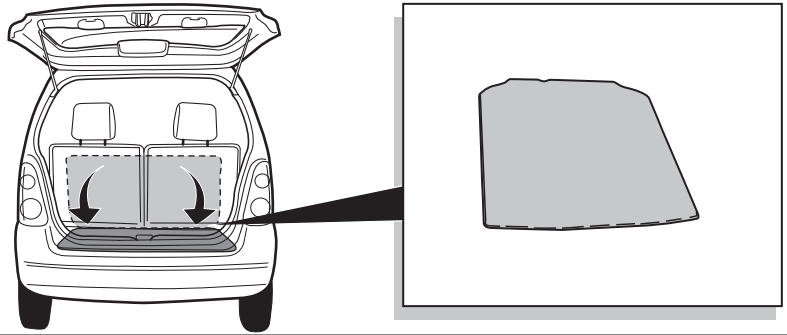

3

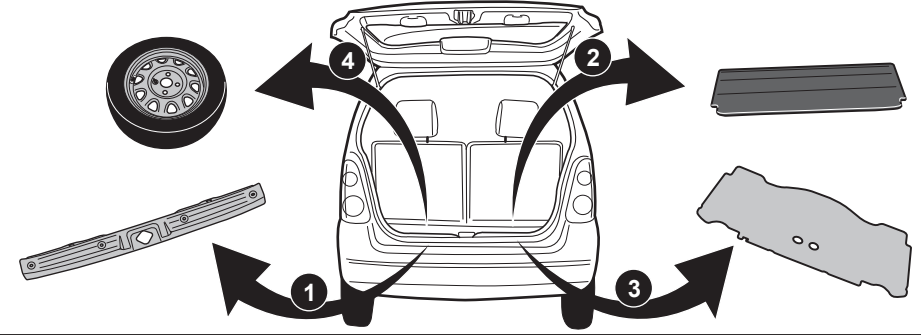

4

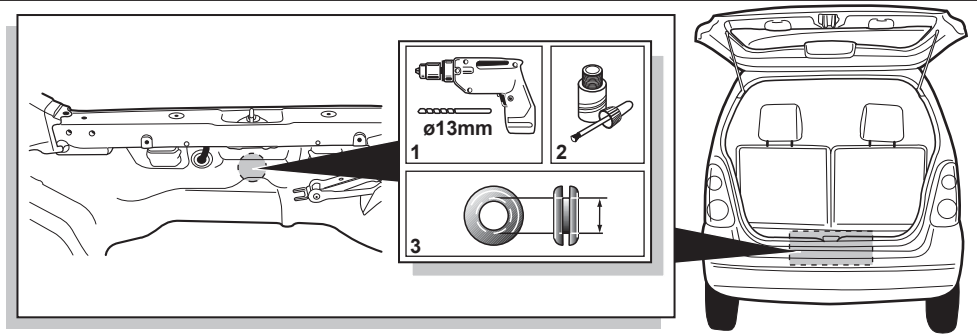

INFO

- D** Dit is een voorbereiding voor de achteruitrijlamp, en deze kan aangesloten worden op een 12S uitbreidingsset. (Engeland)
- D** This is a preparation for the reverse light and can be connected to a 12S extension kit.
- D** Dies ist eine Vorbereitung für die Rückfahrleuchte und kann an einem 12S Erweiterungssatz angeschlossen werden. (England)

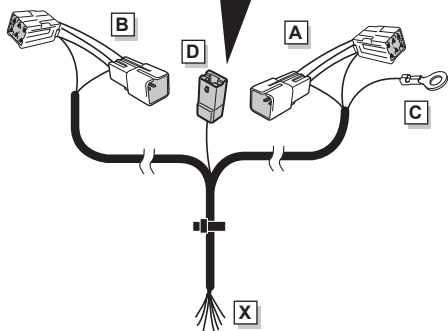

ROUTING

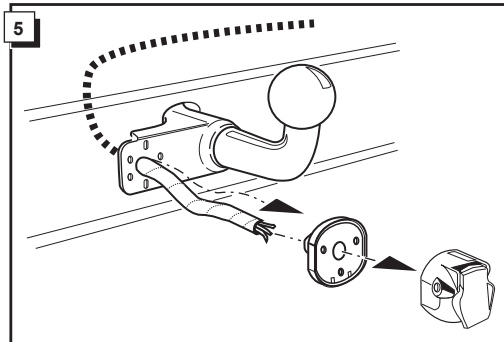
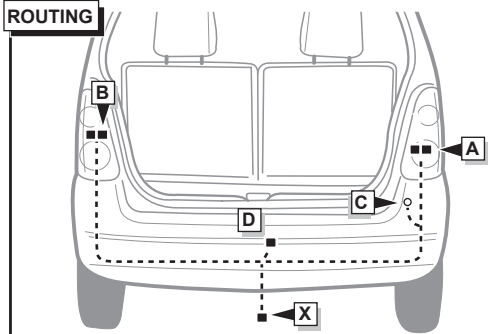

6

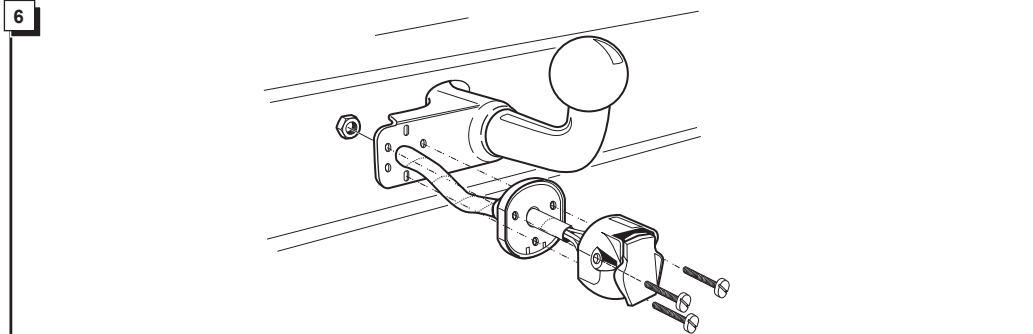

7

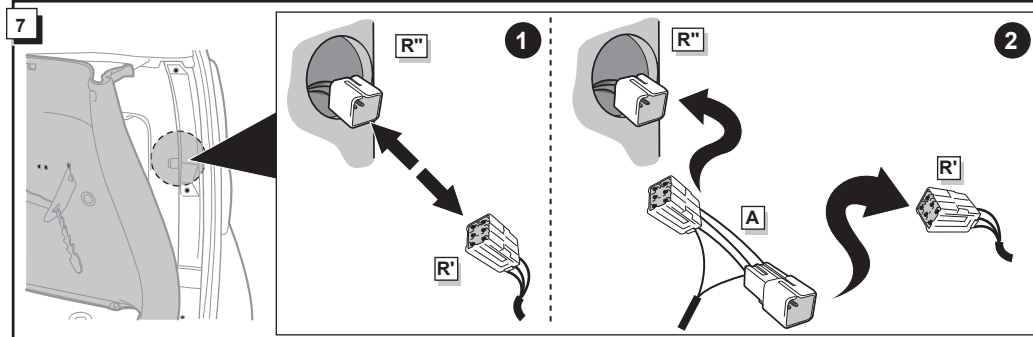

INFO

Anschluß Steckdose / Connection de la prise / Socket connection / Contactdoos aansluiting

DIN/ISO 1724		D	F	GB	NL
←	1/L	gelb	jaune	yellow	geel
↖ ⊕	2/54G	blau	bleu	blue	blauw
⊕ ↖ ⊖ ↗	2A/58-B	grau	gris	grey	grijs
⊖ 1-8	3/31	weiß	blanc	white	wit
↗	4/R	grün	vert	green	groen
☀	5/58-R	braun	marron	brown	bruin
⊕ STOP	6/54	rot	rouge	red	rood
☀	7/58-L	schwarz	noir	black	zwart

8

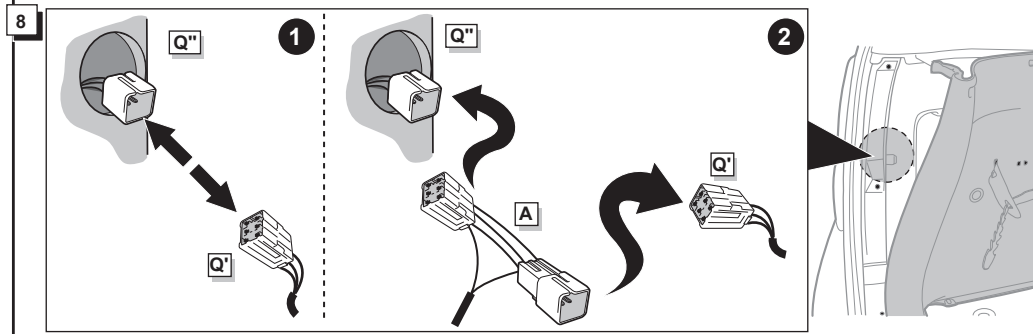

9

