

**Einbauanleitung Elektrosatz  
Anhängervorrichtung mit 12-N Steckdose  
lt. DIN/ISO Norm 1724**

**Instructions de montage du faisceau  
électrique pour crochet d'attelage  
conforme à la norme  
DIN/ISO 1724 prise 12-N**

**Fitting instructions electric wiringkit  
towbar with 12-N socket up to  
DIN/ISO norm 1724**

**Montage-handleiding elektrokabelset voor  
trekhaak met 12-N contactdoos  
vlg. DIN/ISO norm 1724**

**Instrucciones de montaje de  
kit eléctrico para enganche de  
remolque con caja de conexiones  
12-N según norma DIN/ISO 1724**

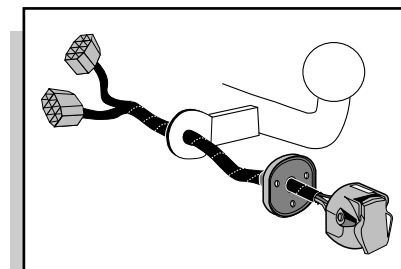

**SEAT CORDOBA 2003-**

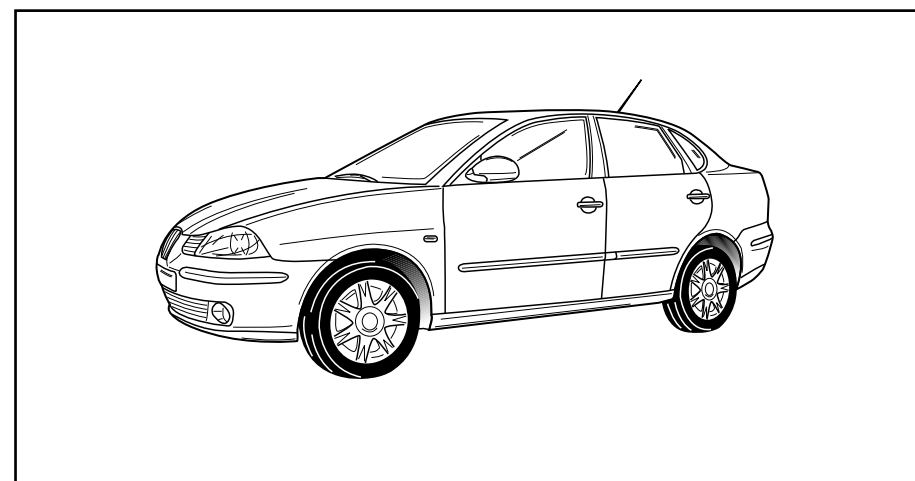

Bestel Nr.: SE-016-BB

\* Teilliste \* Liste de pieces \* Part list \* Onderdelenlijst \* Lista de piezas

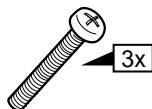
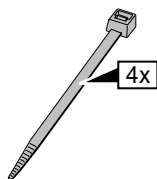
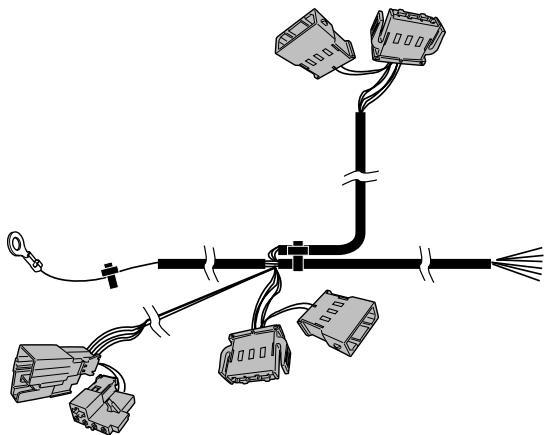
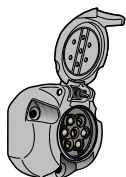
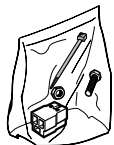
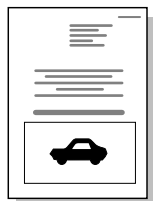
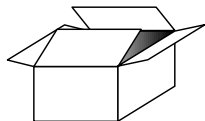

1

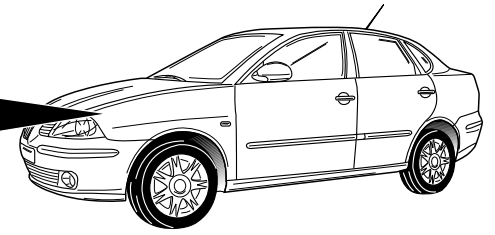
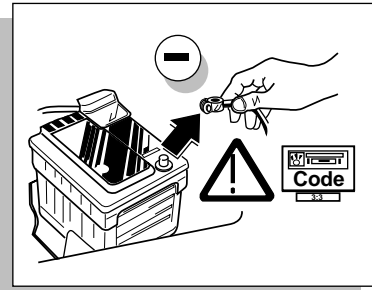

2

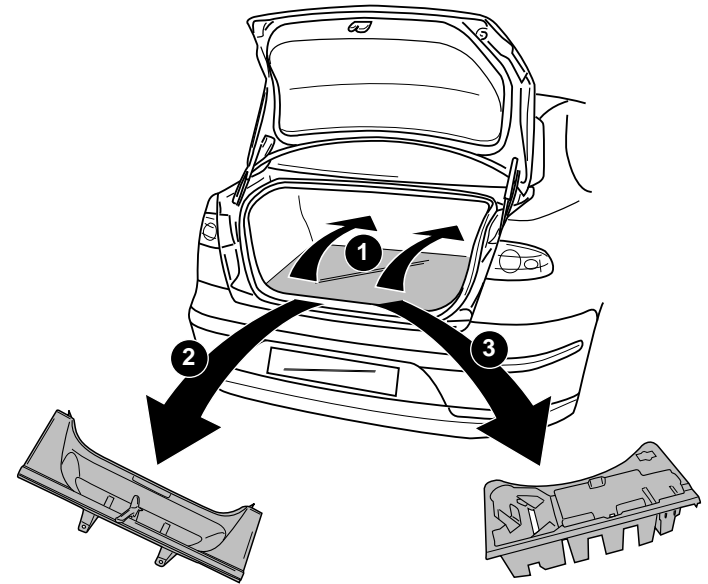

3

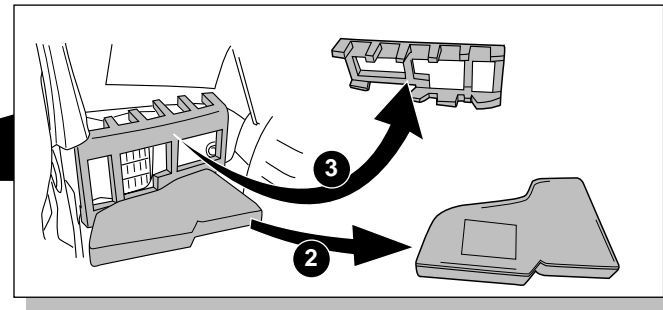
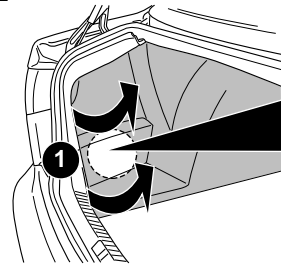

4

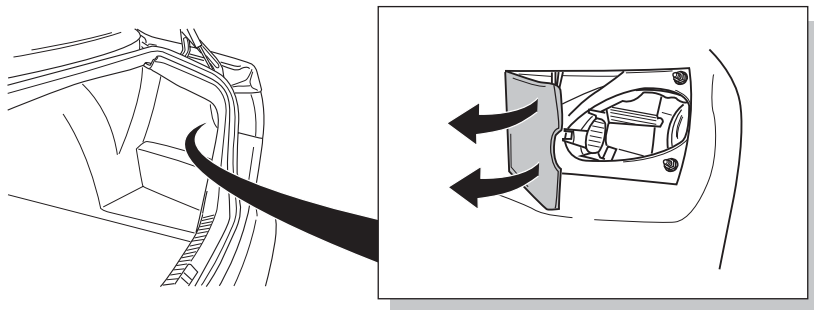

## INFO

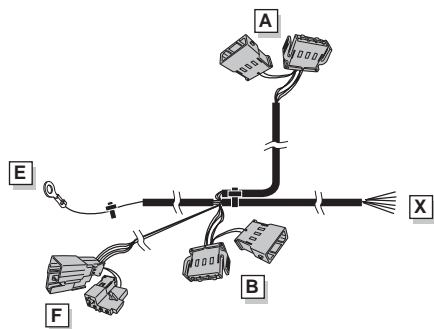

## ROUTING

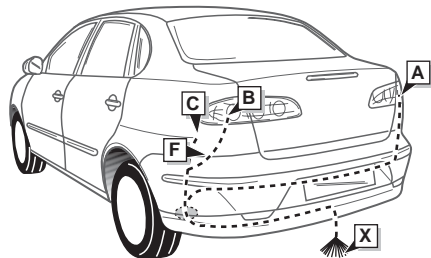

## INFO

- Wir weisen ausdrücklich darauf hin, dass eine unsachgemäße und nicht in einer Fachwerkstätte durchgeführte Montage einen Verzicht auf die Geltendmachung jeglicher Art insbesondere auch aus dem Titel des Produkthaftpflichtrechtes bewirkt.
- Technische Änderungen vorbehalten.
- Belastung nur tabellengemäß auf dem Anhänger verwenden, siehe Seite 3.

D

- Il est expressément prévu qu' on ne saurait se prévaloir d'un quelconque préjudice contractuel ou rédhitoire si le montage avait été fait en dépit des dites instructions ou dans un garage ne disposant pas des équipements adéquats.
- Sous réserve de modifications techniques.
- Ne excédez pas la charge maximale, indiquée dans le tableau sur page 3.

F

- We would expressly point out that any improper assembly which is not carried out in a specialist workshop will result in the renunciation of the enforcement of compensation claims of any kind, in particular those arising by virtue of the product liability law.
- Subject to alteration without notice.
- Only use maximum charge according to connection table on towed vehicle, see page 3.

GB

- Wij wijzen er met nadruk op, dat ondeskundige en niet door een vakkundige werkplaats uitgevoerde montage tot gevolg heeft dat daardoor ieder recht op schadevergoeding, ook op wettelijke aansprakelijkheid inzake producten, vervalt.
- Technische wijzigingen voorbehouden.
- Gebruik alleen belasting volgens aansluittabel op het getrokken voertuig, zie pagina 3.

NL

- El montaje inapropiado y efectuado por personal no cualificado originará la pérdida de todo derecho a indemnización o la expiración de toda responsabilidad civil con respecto al producto.
- Nos reservamos el derecho a efectuar modificaciones técnicas.
- Utilice sólo cargas de acuerdo a la tabla de conexión del vehículo remolcado (ver página 3).

ES

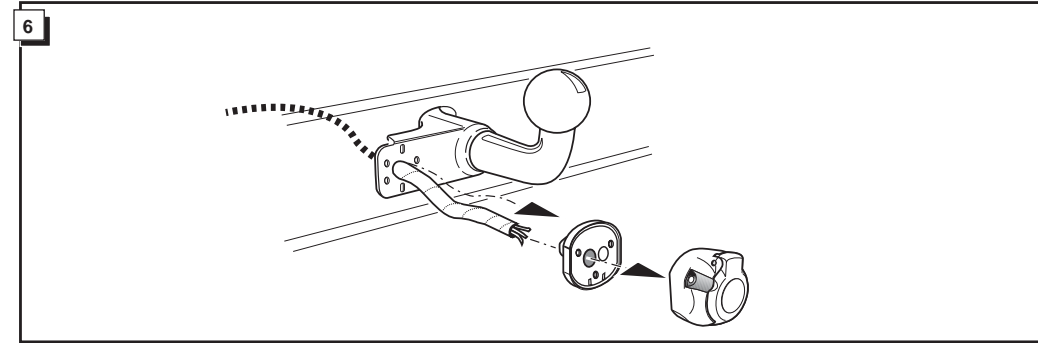
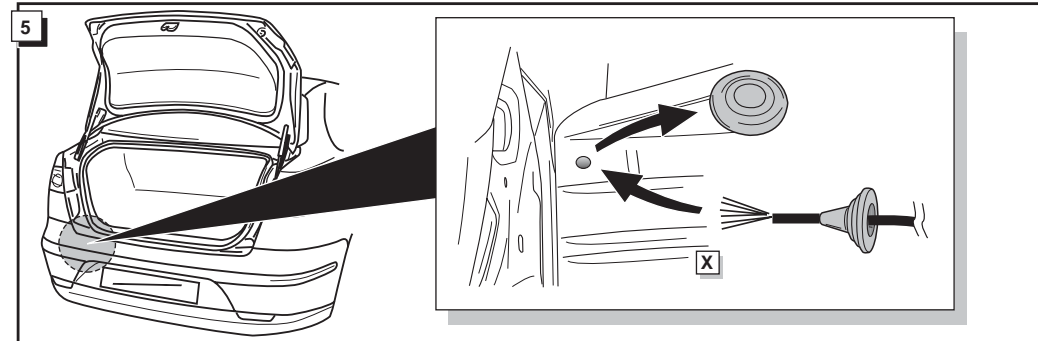
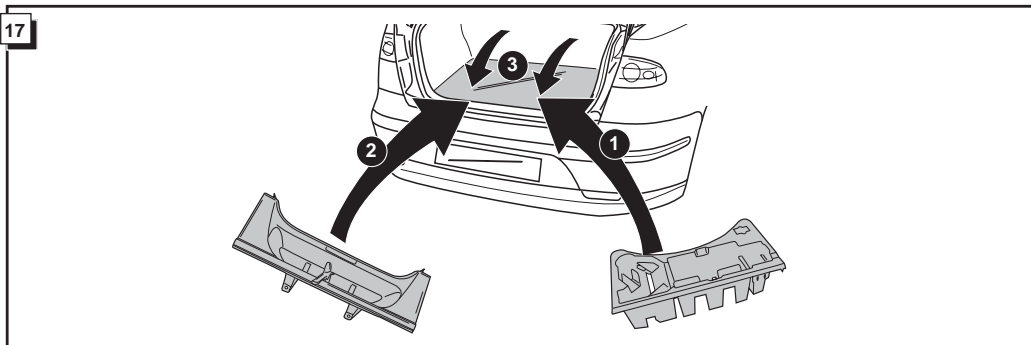
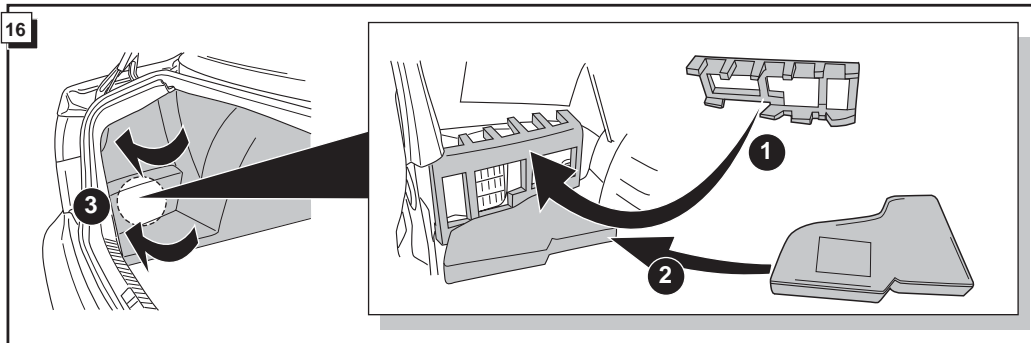
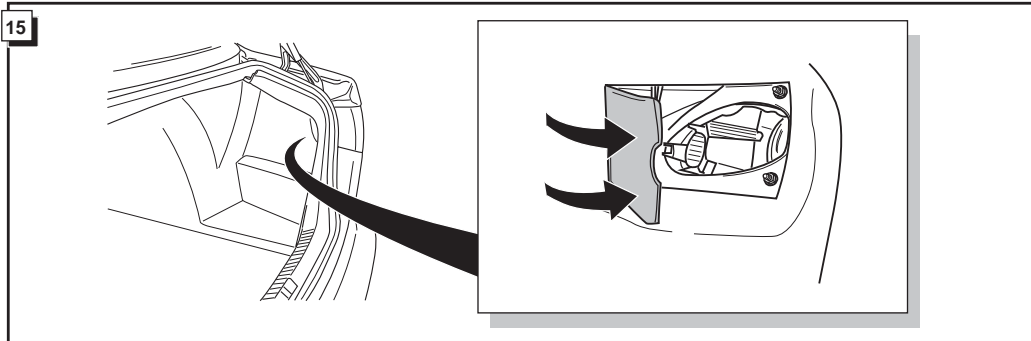

7

**Anschluß Steckdose / Connection de la prise / Socket connection / Contactdoos aansluiting / Conexiones del enchufe**

DIN/ISO 11446		D	F	GB	NL	ES	P <sub>max</sub>
	1/L	gelb	jaune	yellow	geel	amarillo	21W
	2	blau	bleu	blue	blauw	azul	2x21W
	3/31	weiß	blanc	white	wit	blanco	
	4/R	grün	vert	green	groen	verde	21W
	5/58-R	braun	marron	brown	bruin	marrón	52W
	6/54	rot	rouge	red	rood	rojo	3x21W
	7/58-L	schwarz	noir	black	zwart	negro	52W
	8/58-bl	grau	gris	grey	grijs	gris	2x21W

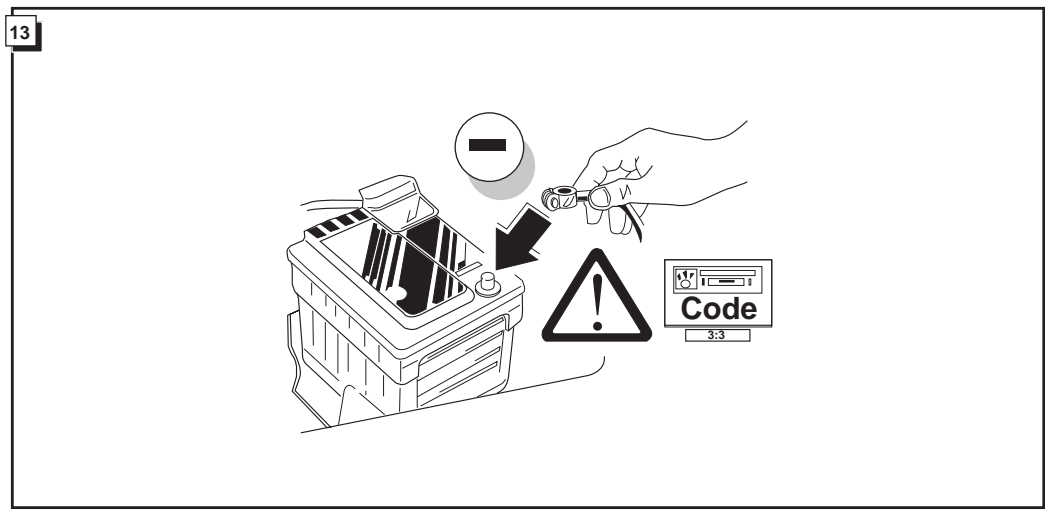
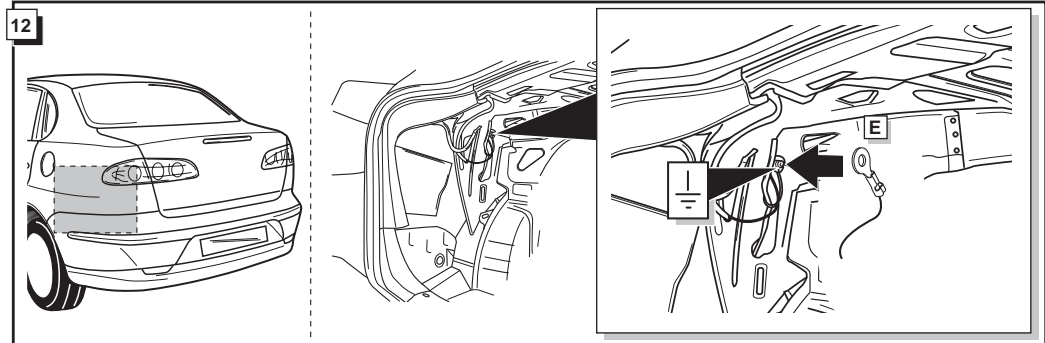
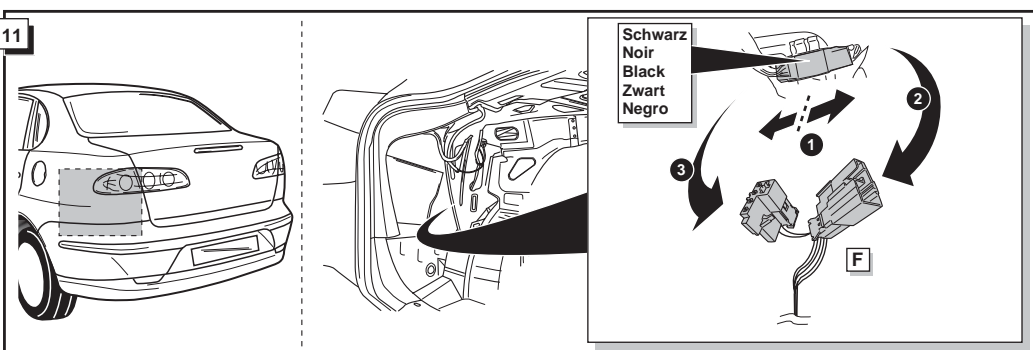
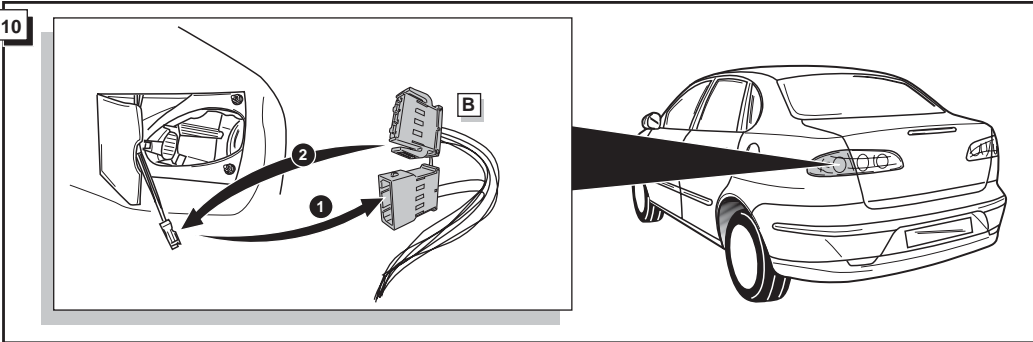
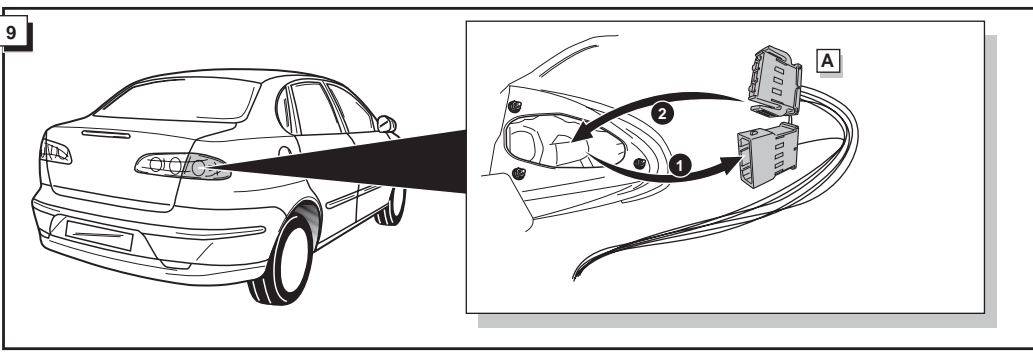
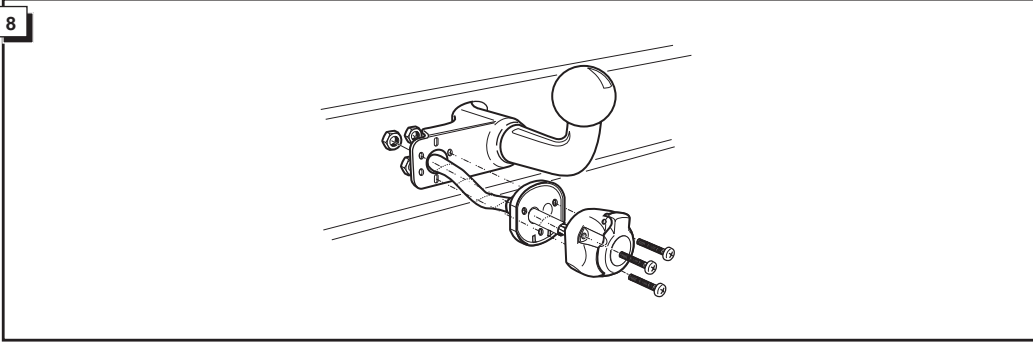

14

**FUNKTIONEN KONTROLLIEREN MIT EINEN TESTKASTEN MIT BELASTUNG ODER MIT LEUCHTEN MIT DER GENAUEN MENGE DES WATTS !**

**CONTRÔLER LES FONCTIONS AVEC UNE BOÎTE DE TEST AVEC DE LA CHARGE OU DES LAMPES AVEC LA QUANTITÉ CORRECTE DE WATT !**

**CHECK FUNCTIONS WITH A TESTBOX WITH LOAD OR LAMPS WITH THE RIGHT AMOUNT OF WATT !**

**CONTROLEER FUNCTIES MET EEN TESTER MET BELASTING OF LAMPEN MET DE JUISTE WATTAGE !**

**¡CONTROLAR LAS FUNCIONES CON UN TESTER CON CARGA O LUCES CON EL CORRECTO VOLTAJE!**