

**Einbauanleitung Elektrosatz
Anhängervorrichtung mit 12-N Steckdose
lt. DIN/ISO Norm 1724**

**Instructions de montage du faisceau
électrique pour crochet d'attelage
conforme à la norme
DIN/ISO 1724 prise 12-N**

**Fitting instructions electric wiringkit
towbar with 12-N socket up to
DIN/ISO norm 1724**

**Montage-handleiding elektrokabelset voor
trekhaak met 12-N contactdoos
vlg. DIN/ISO norm 1724**

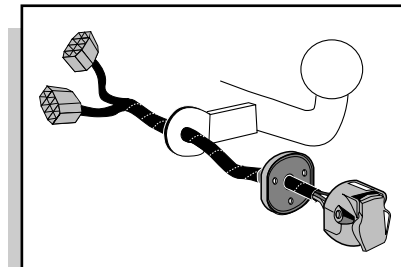

SEAT CORDOBA SEDAN 1999-

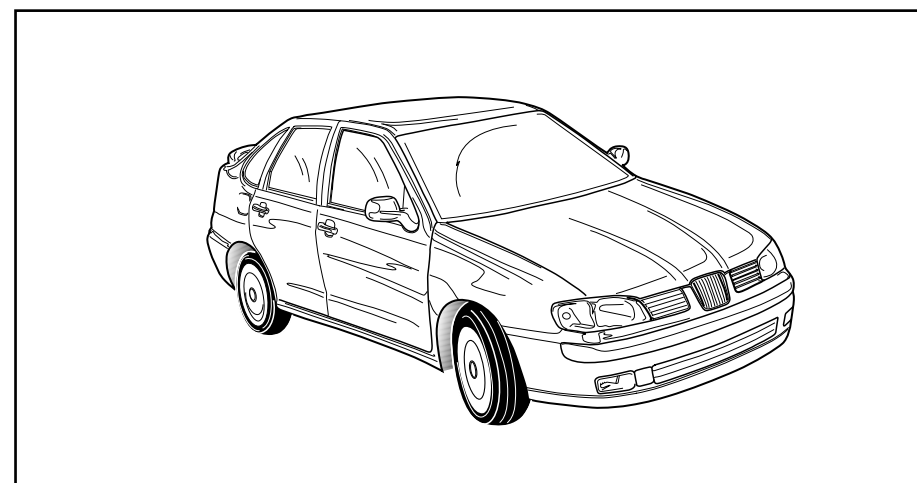

Bestel Nr.: SE-007-BB

* Teilliste

* Liste de pieces

* Part list

* Onderdelenlijst

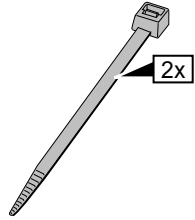
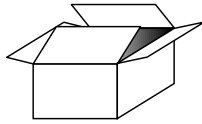

2x

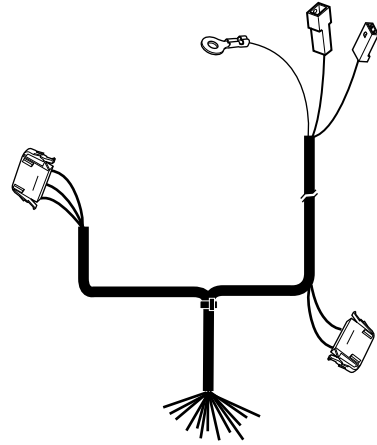
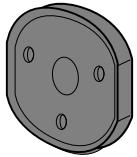
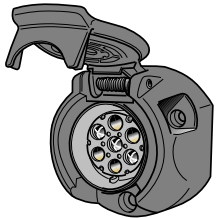

1x



1x



3x

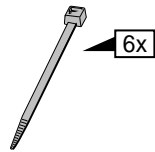

6x

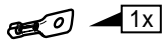

1x



1x

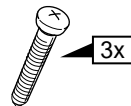

3x

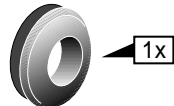

1x

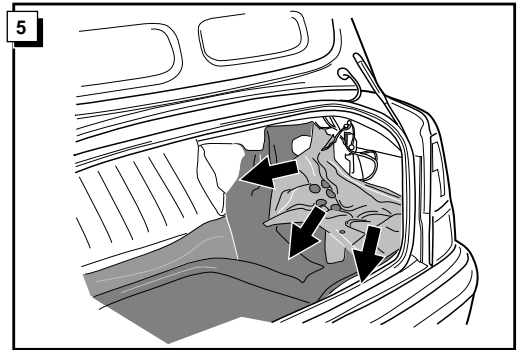
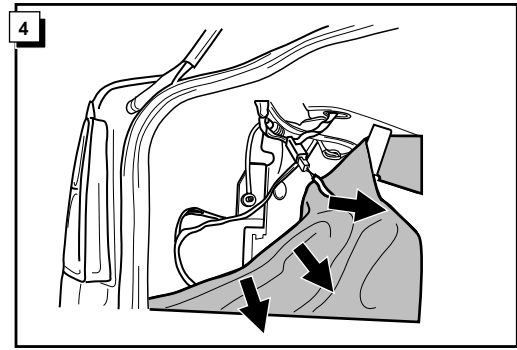
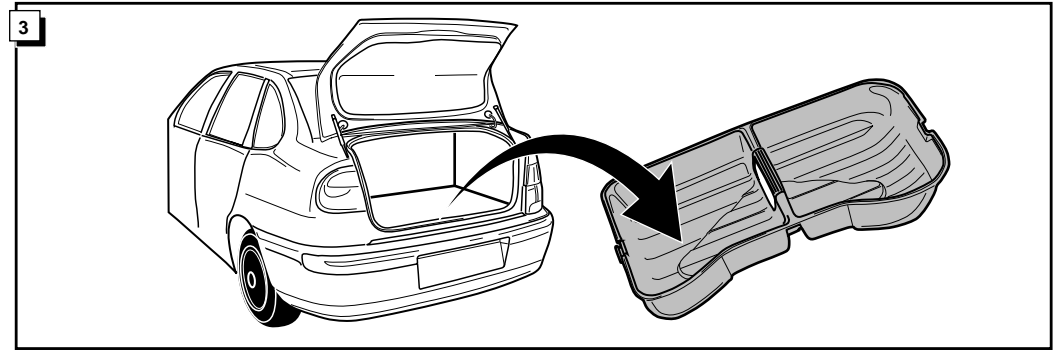
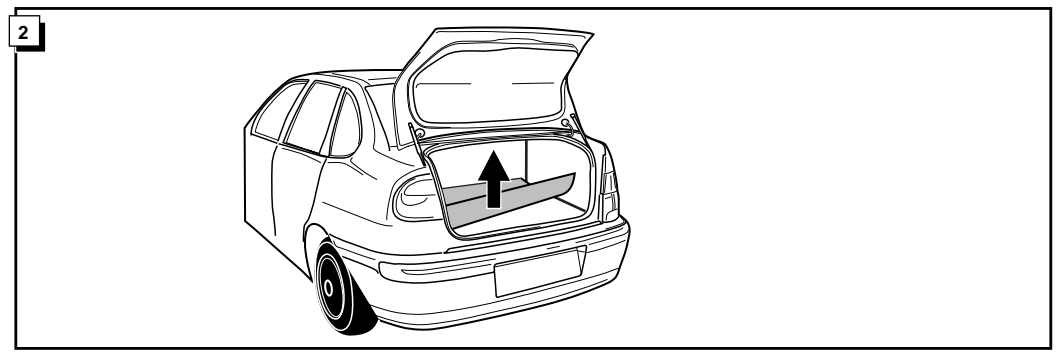
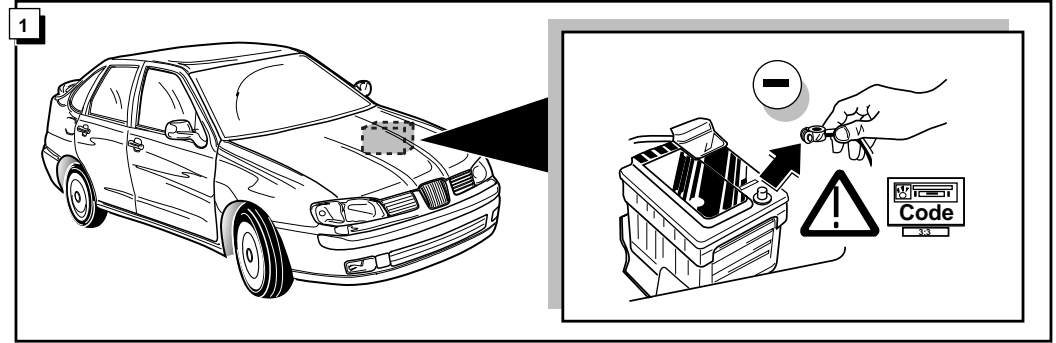

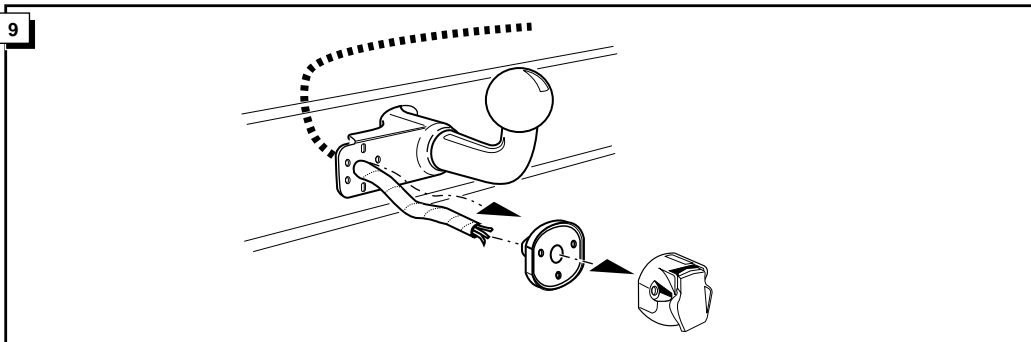
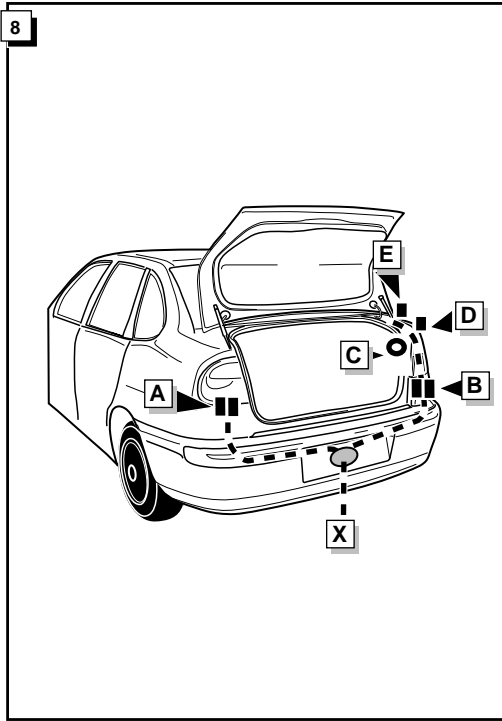
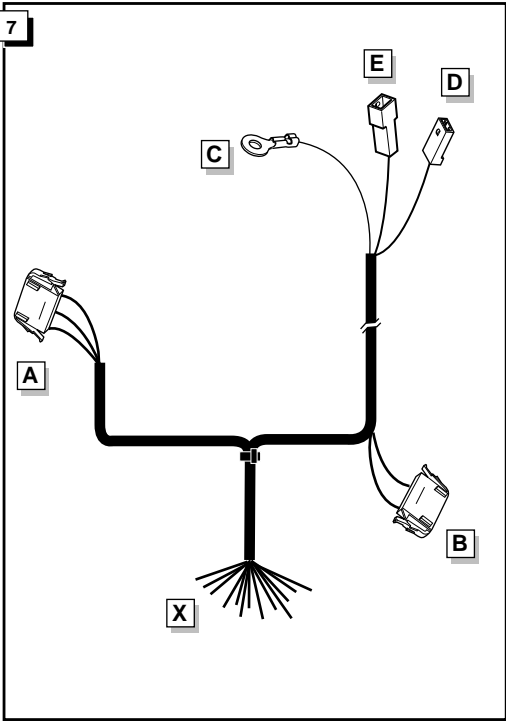
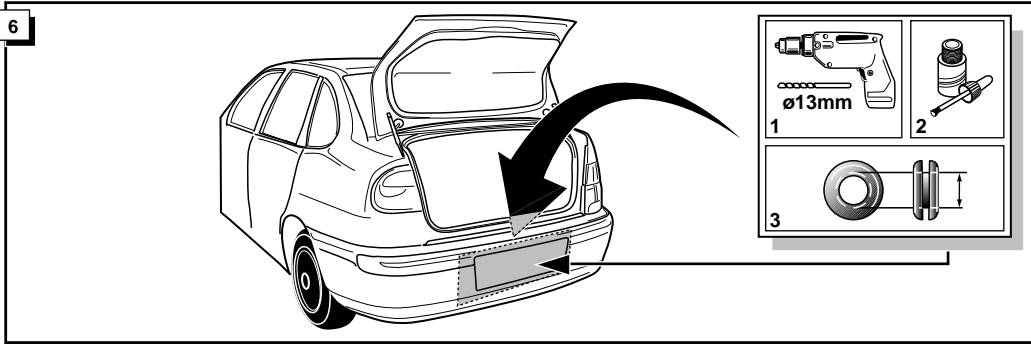

DIN/ISO 1724		(D)	(F)	(GB)	(NL)
	1/L	gelb	jaune	yellow	geel
	2	blau	bleu	blue	blauw
	3/31	weiß	blanc	white	wit
	4/R	grün	vert	green	groen
	5/58-R	braun	marron	brown	bruin
	6/54	rot	rouge	red	rood
	7/58-L	schwarz	noir	black	zwart
	8/58-b	grau	gris	grey	grijs

10

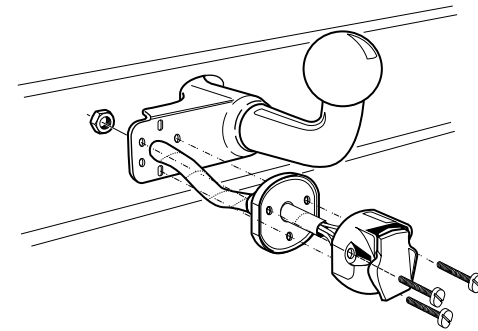

11

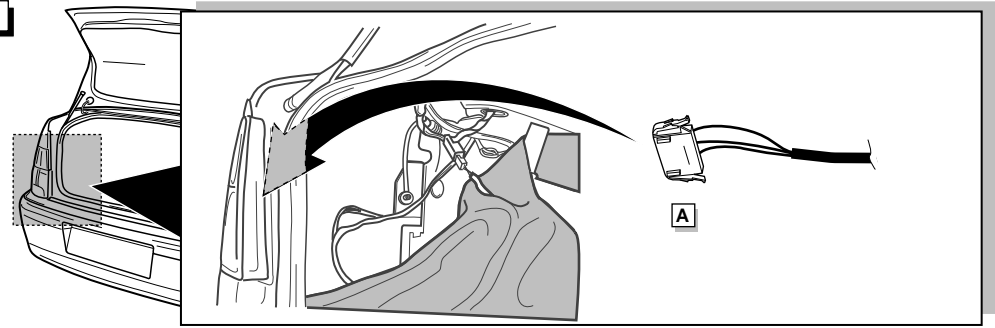

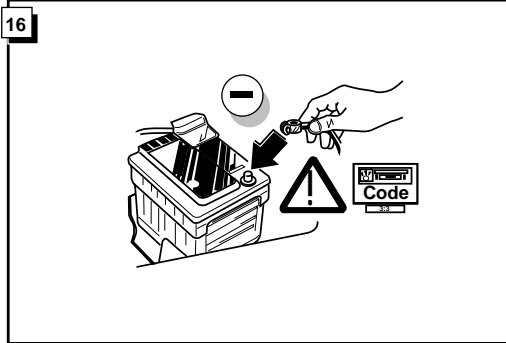
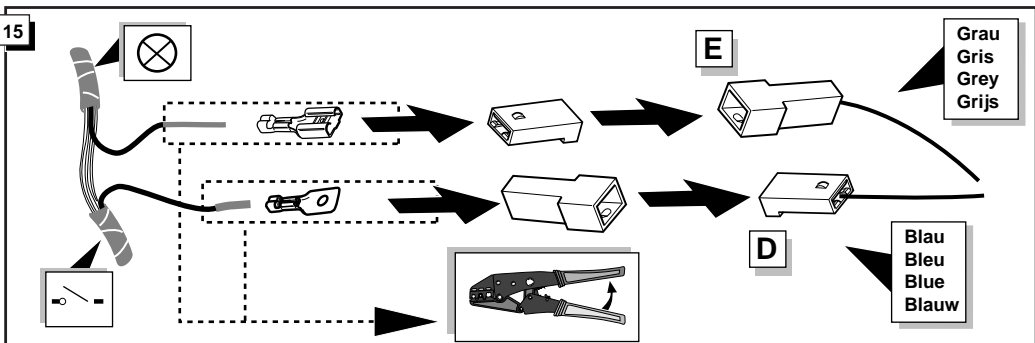
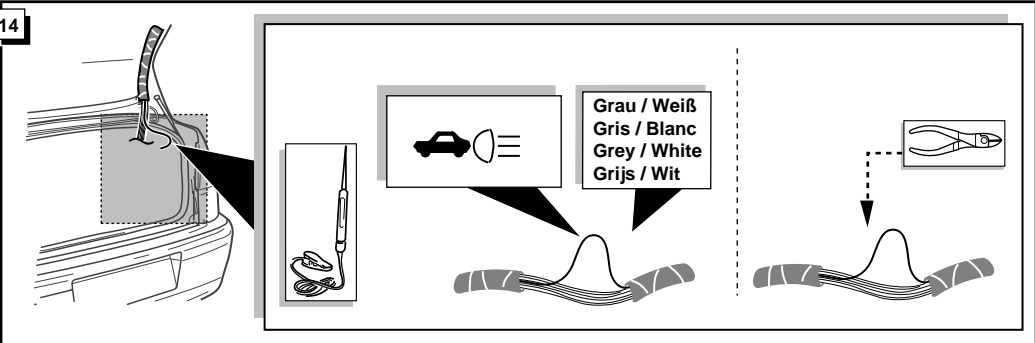
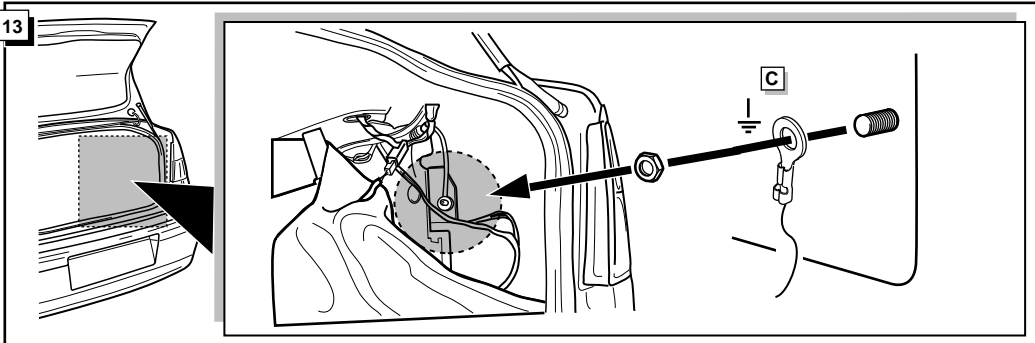
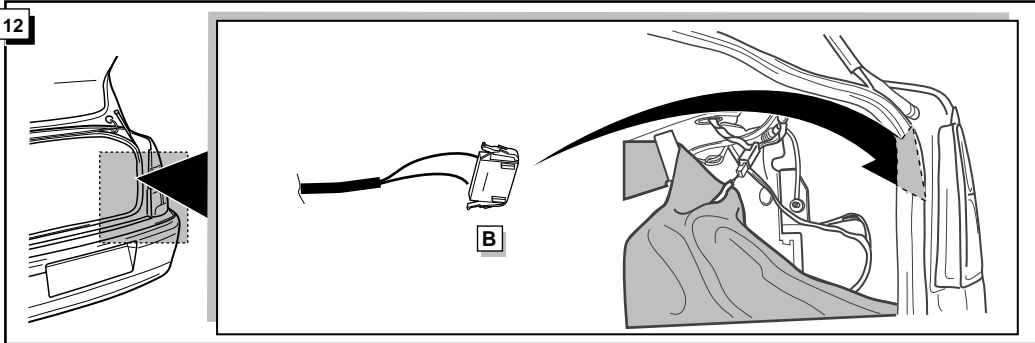

17

! FUNKTIONEN KONTROLLIEREN !
! CONTRÔLER LES FONCTIONS !
! CHECK FUNCTIONS !
! CONTROLEER FUNCTIES !

