

Einbauanleitung Elektrosatz
Anhängervorrichtung mit 13-P Steckdose
lt. DIN/ISO Norm 11446

Instructions de montage du faisceau
électrique pour crochet d'attelage
conforme à la norme DIN/ISO 11446
prise 13-P

Fitting instructions electric wiringkit
towbar with 13-P socket up to
DIN/ISO norm 11446

Montage-handleiding elektrokabelset voor
trekhaak met 13-P contactdoos
vlgs. DIN/ISO norm 11446

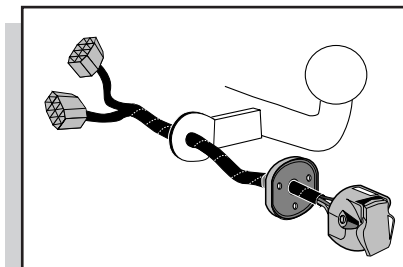

SEAT CORDOBA VARIO 1999-

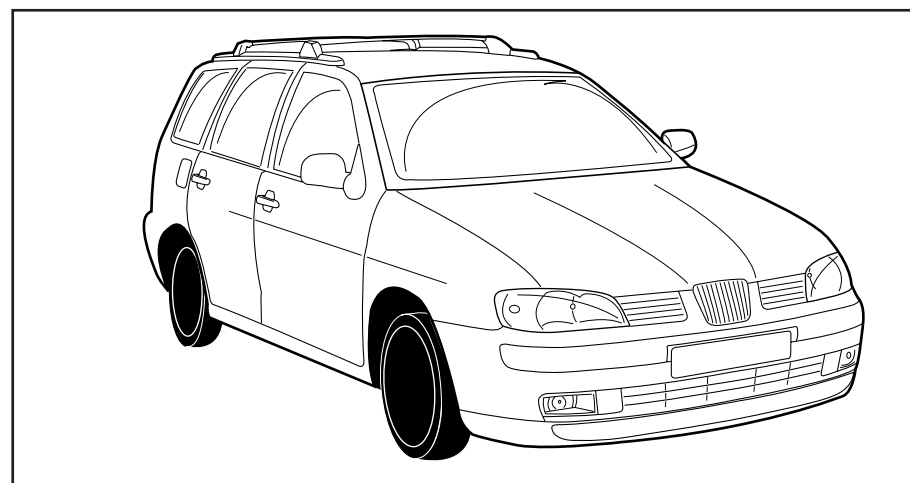

Bestel Nr.: SE-005-DB

* Teilliste

* Liste de pieces

* Part list

* Onderdelenlijst

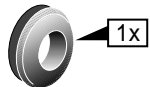
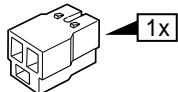
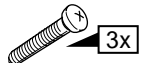
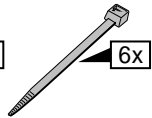
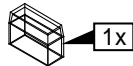
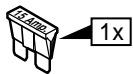
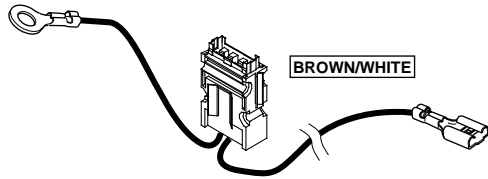
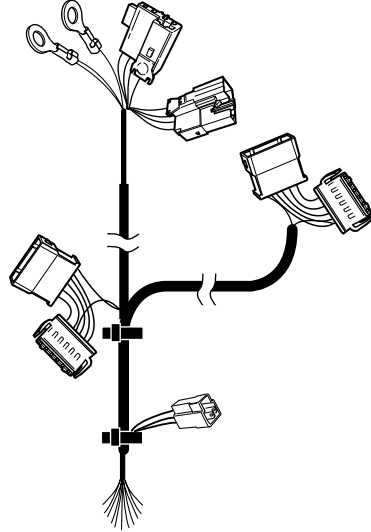
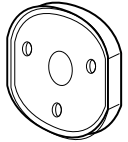
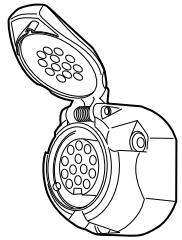
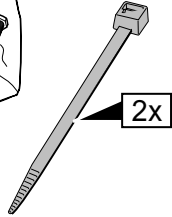
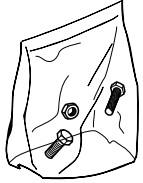
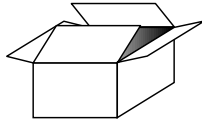

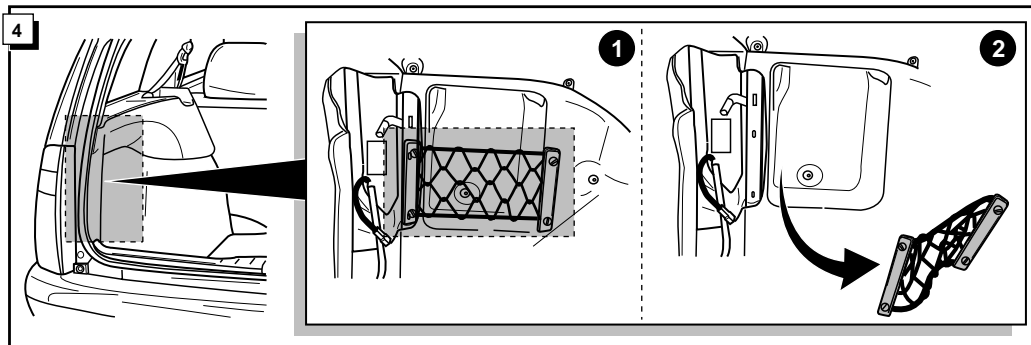
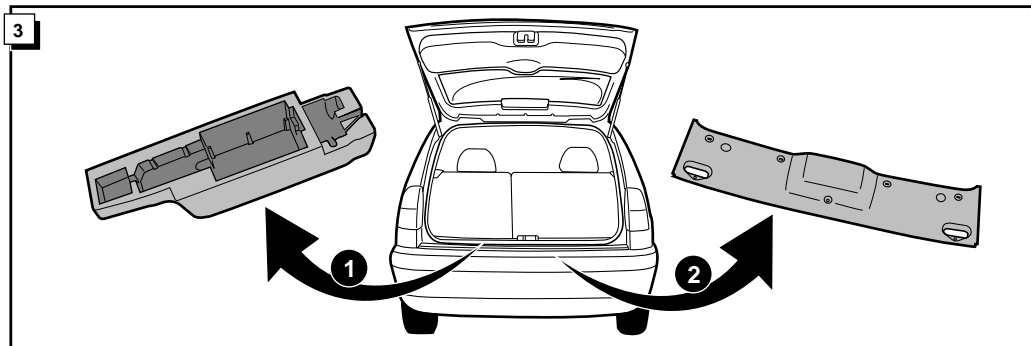
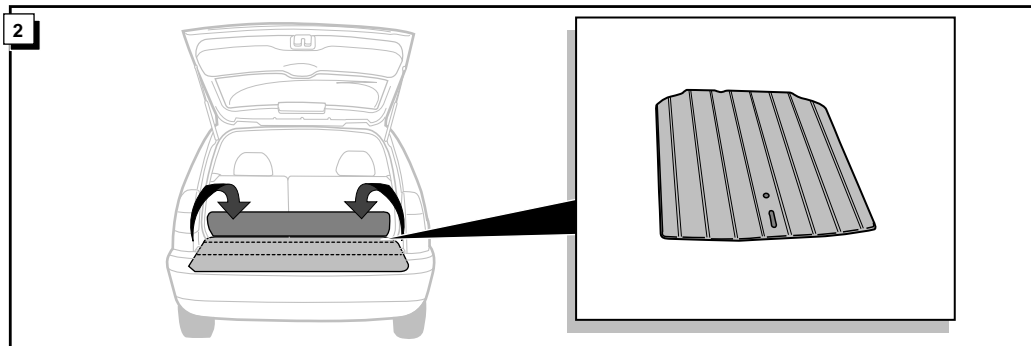
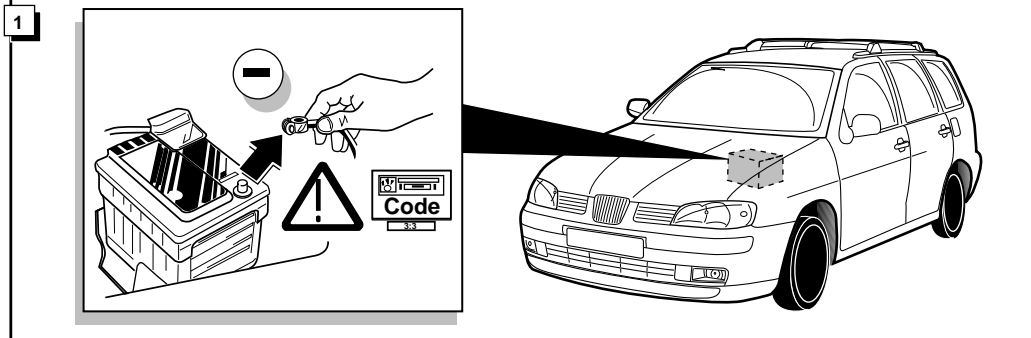

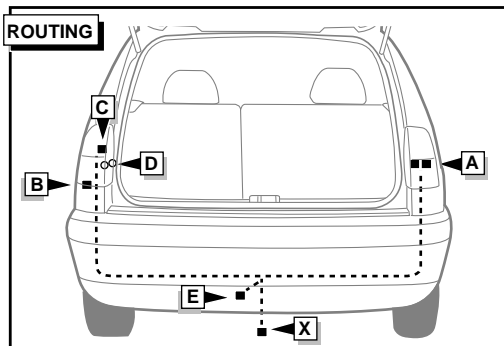
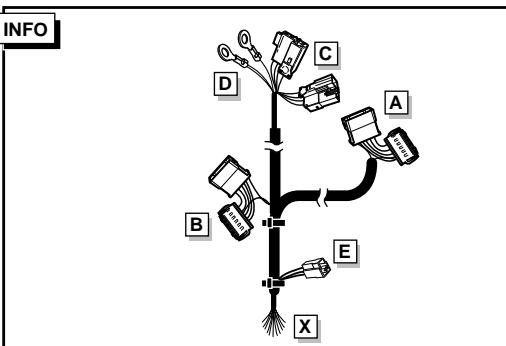
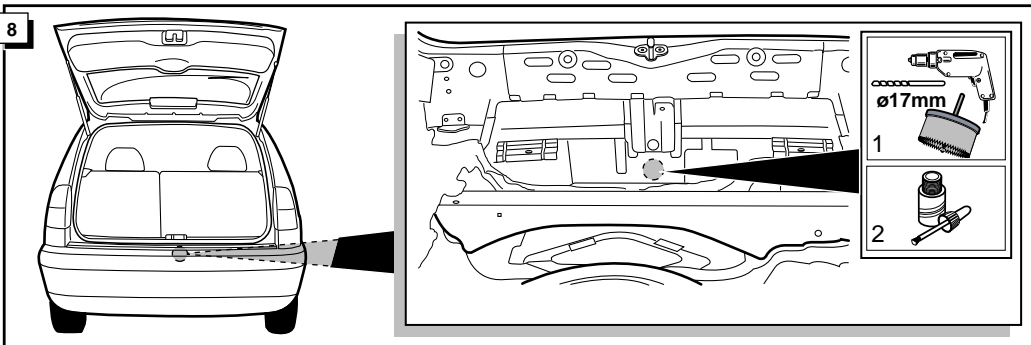
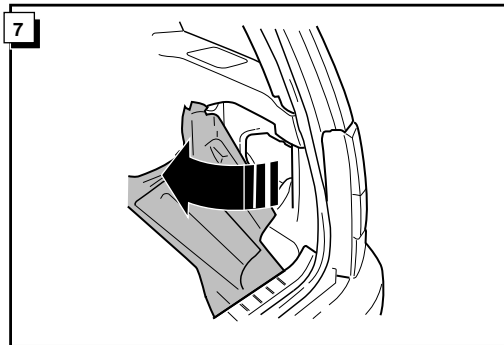
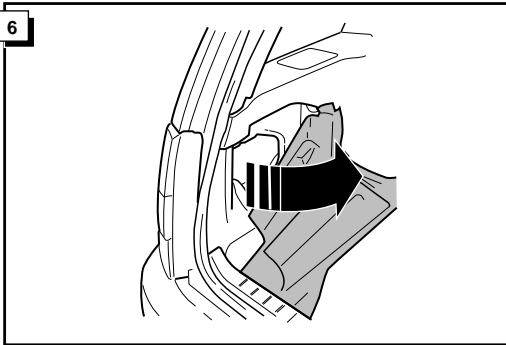
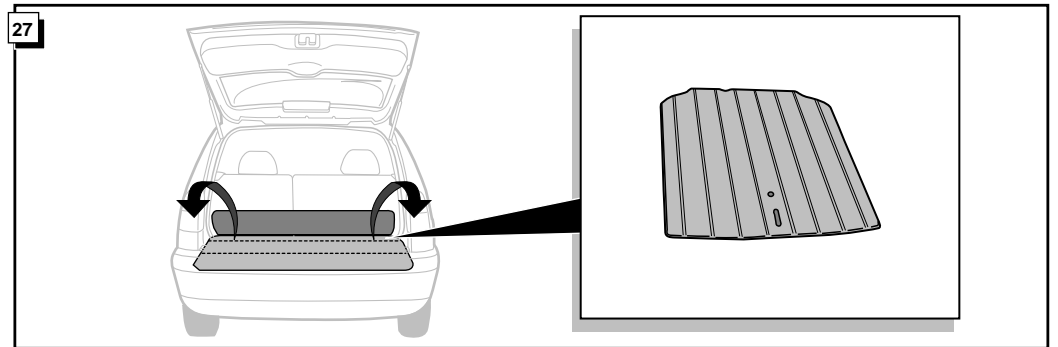
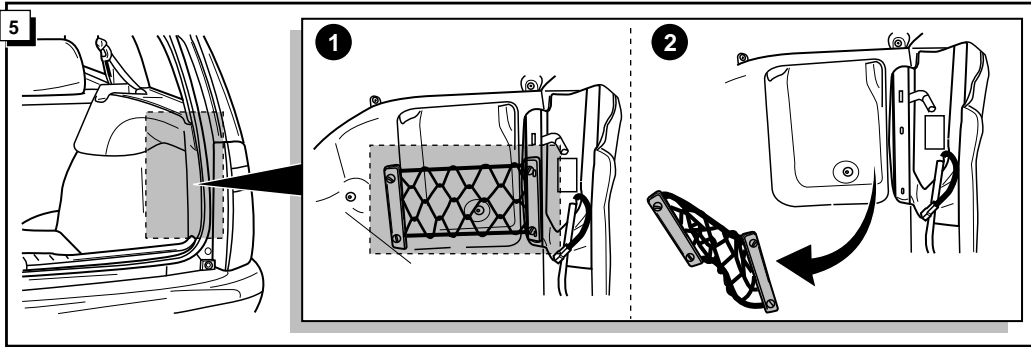

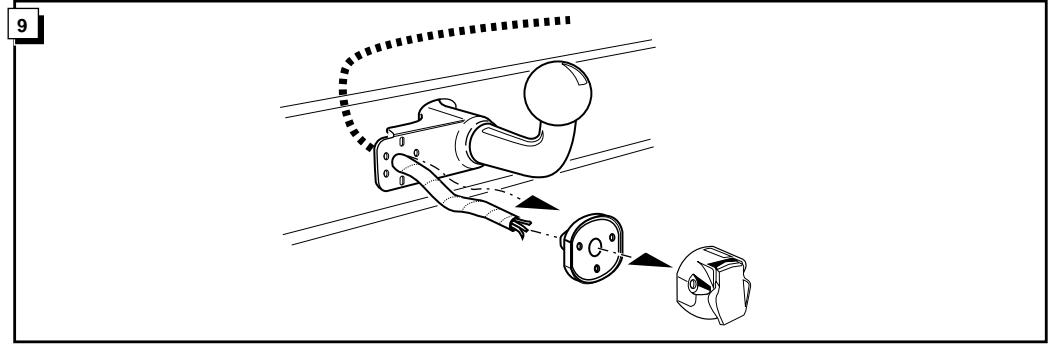
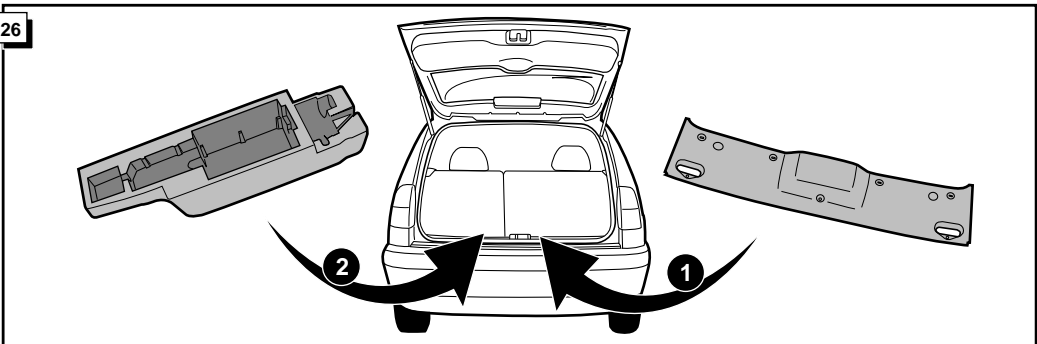
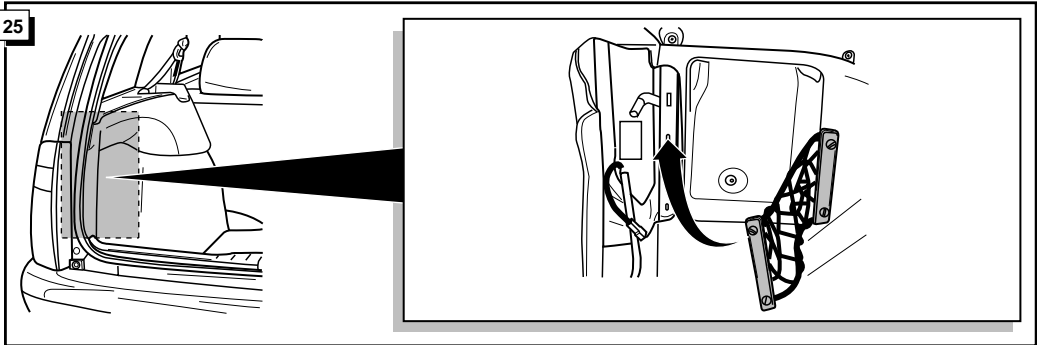
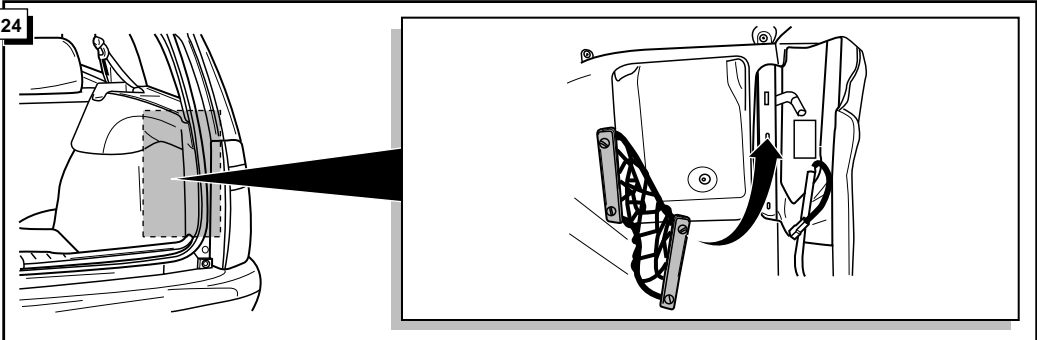
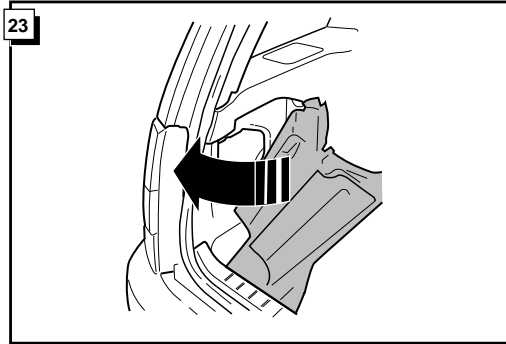
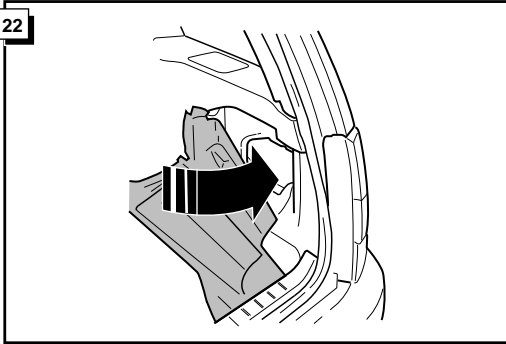

INFO Anschluß Steckdose / Connection de la prise / Socket connection / Contactdoos aansluiting

DIN/ISO 11446		(D)	(F)	(GB)	(NL)
	1/L	gelb	jaune	yellow	geel
	2	blau	bleu	blue	blauw
	2a	grau	gris	grey	grijs
	3/31	weiß	blanc	white	wit
	4/R	grün	vert	green	groen
	5/58-R	braun	marron	brown	bruin
	6/54	rot	rouge	red	rood
	7/58-L	schwarz	noir	black	zwart
	8	schwarz/rot	noir/rouge	black/red	zwart/rood
	9	braun/weiß	marron/blanc	brown/white	bruin/wit
	10	rot	rouge	red	rood
	11	weiß	blanc	white	wit
	12	rot/blau	rouge/bleu	red/blue	rood/blauw
	13	weiß	blanc	white	wit

