

Einbauanleitung Elektrosatz
Anhängervorrichtung mit 12-N Steckdose
lt. DIN/ISO Norm 1724

Instructions de montage du faisceau
électrique pour crochet d'attelage
conforme à la norme
DIN/ISO 1724 prise 12-N

Fitting instructions electric wiringkit
towbar with 12-N socket up to
DIN/ISO norm 1724

Montage-handleiding elektrokabelset voor
trekhaak met 12-N contactdoos
vlgs. DIN/ISO norm 1724

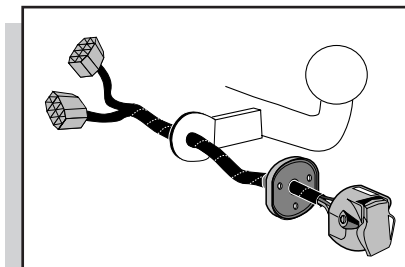

PEUGEOT 406 BREAK 1999-

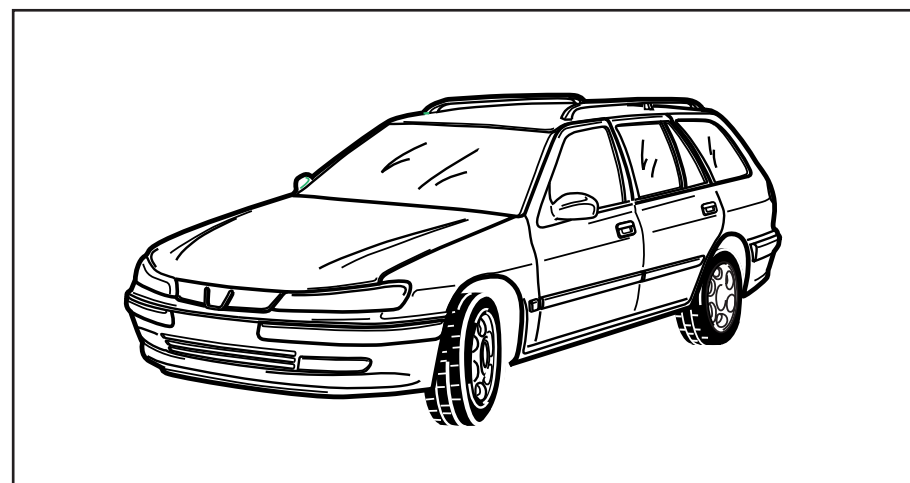

Bestel Nr.: PE-004-BB

* Teilliste

* Liste de pieces

* Part list

* Onderdelenlijst

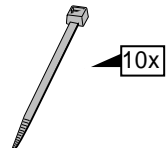
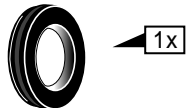
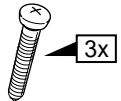
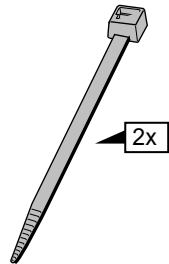
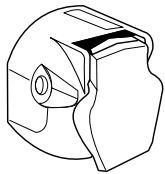
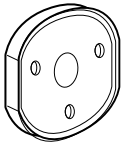
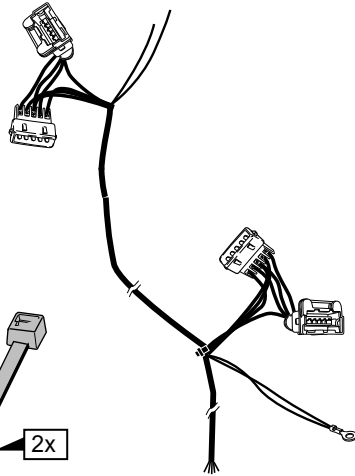
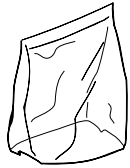
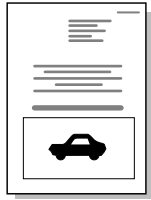
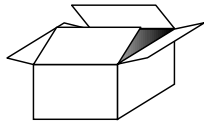

1

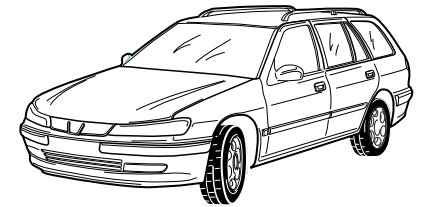
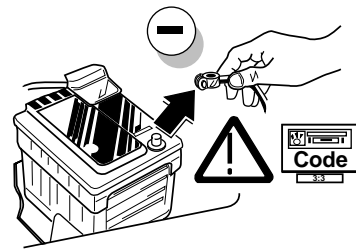

2

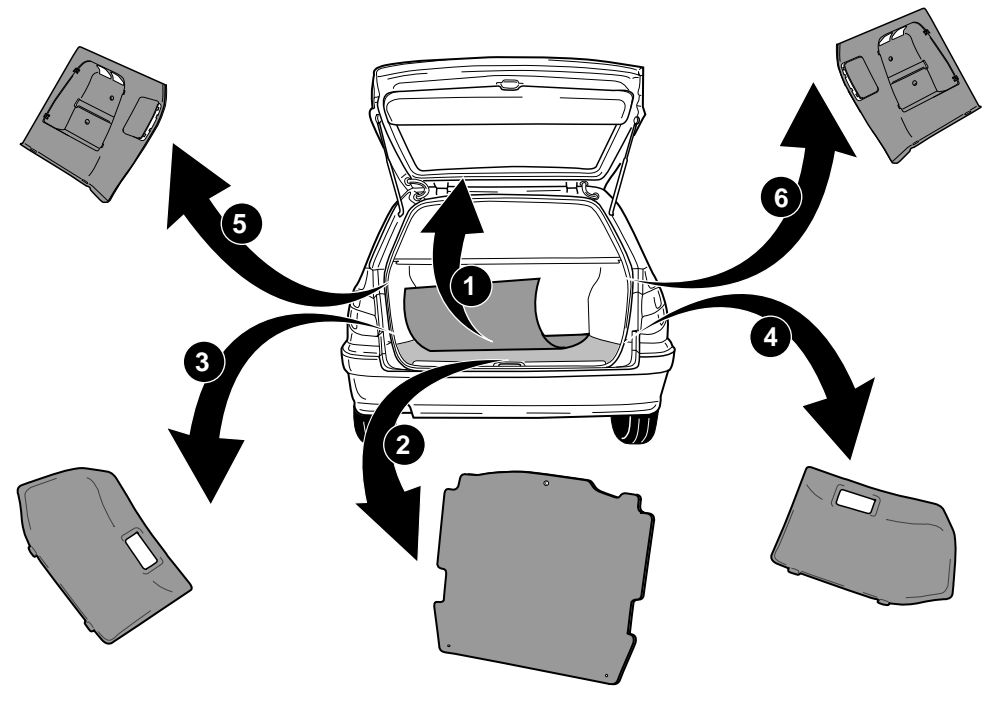

3

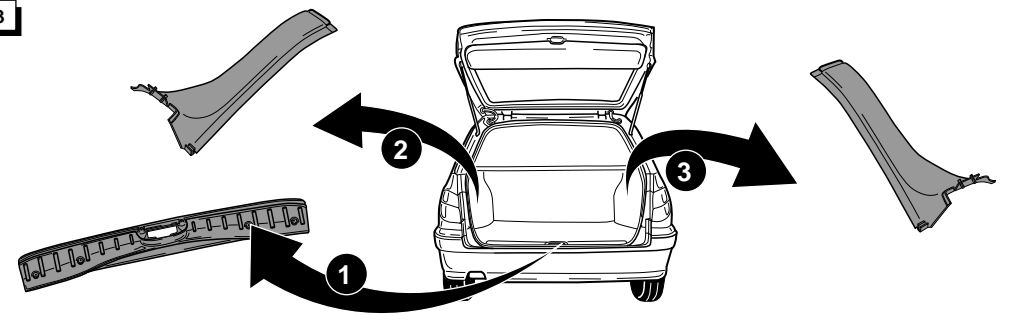

4

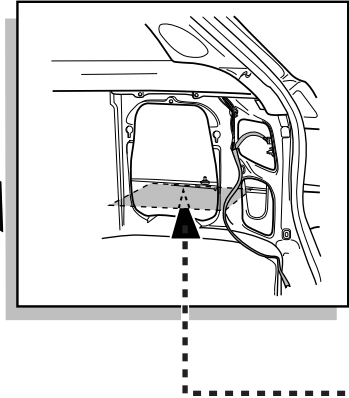
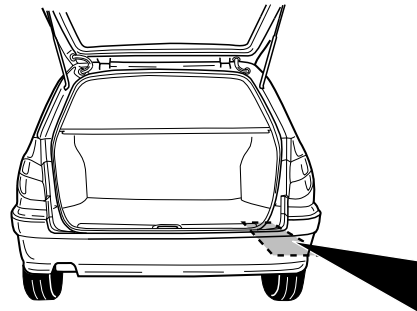
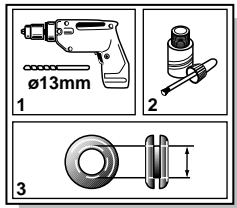

INFO

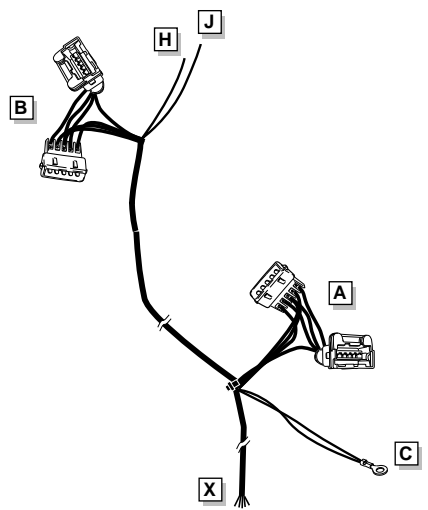

ROUTING

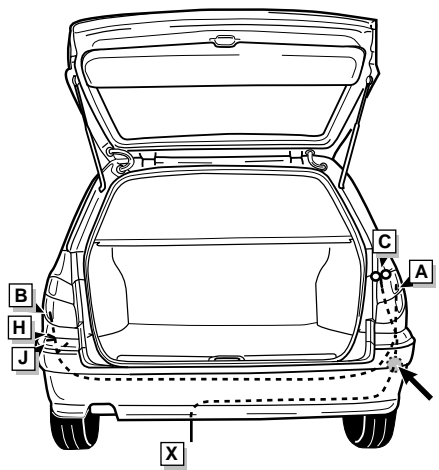

15

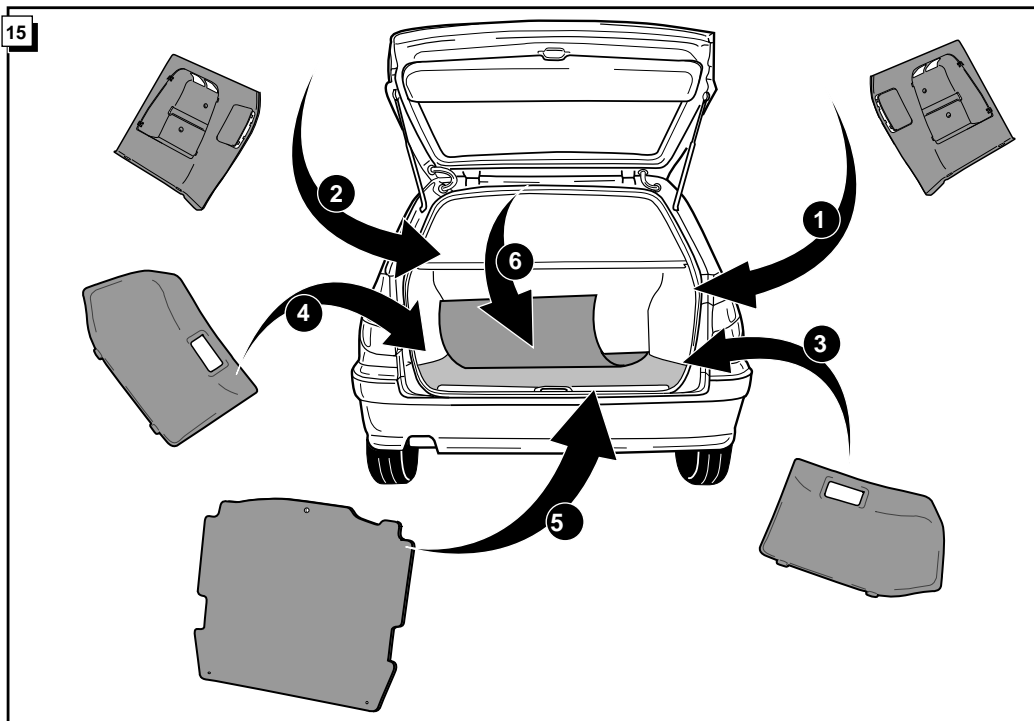

5

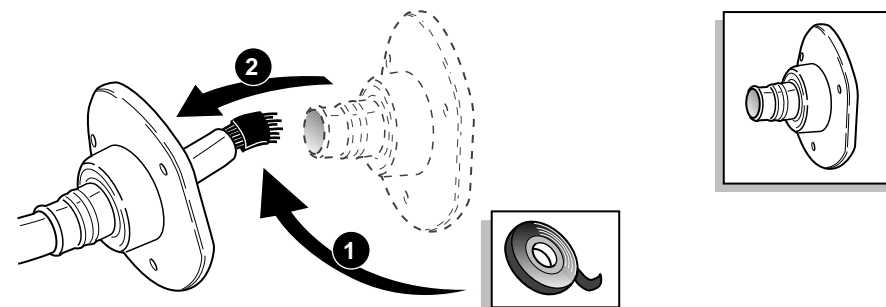

INFO Anschluß Steckdose / Connection de la prise / Socket connection / Contactdoos aansluiting

DIN/ISO 1724		D	F	GB	NL
	1/L	gelb	jaune	yellow	geel
	2	blau	bleu	blue	blauw
	3/31	weiß	blanc	white	wit
	4/R	grün	vert	green	groen
	5/58-R	braun	marron	brown	bruin
	6/54	rot	rouge	red	rood
	7/58-L	schwarz	noir	black	zwart
	8/58-b	grau	gris	grey	grijs

6

