

Montage-handleiding elektrokabelset voor  
trekhaak met 12-N contactdoos  
vlg. DIN/ISO norm 1724

Fitting instructions electric wiringkit  
towbar with 12-N socket up to  
DIN/ISO norm 1724

Einbauanleitung Elektrosatz  
Anhängervorrichtung mit 12-N Steckdose  
lt. DIN/ISO Norm 1724

Instructions de montage du faisceau  
électrique pour crochet d'attelage  
conforme à la norme DIN/ISO 1724  
prise 12-N

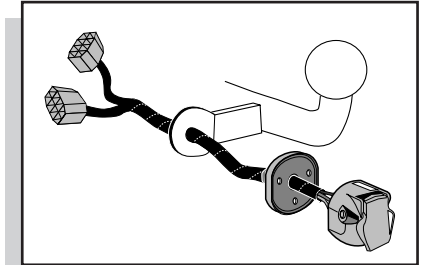

## OPEL VECTRA 1995- WITHOUT PREPARED CONNECTORS / WITHOUT CHECK CONTROL

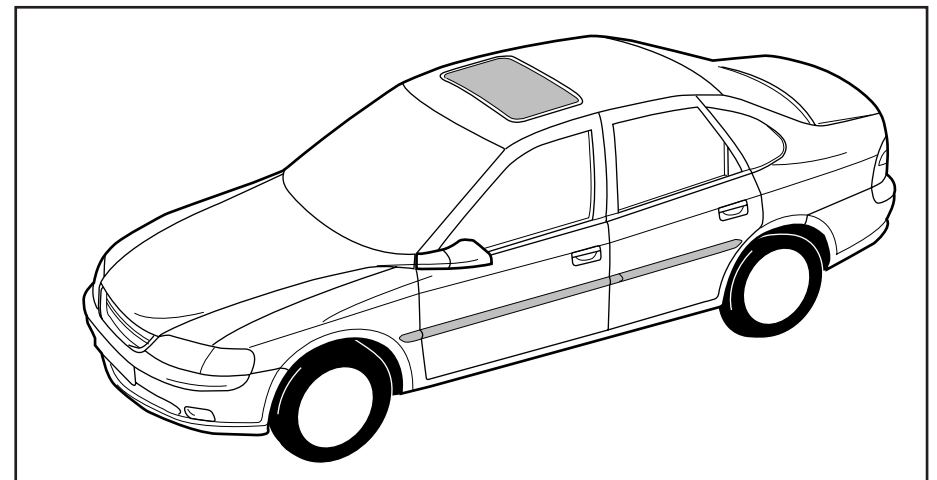

Bestel Nr.: OPE-034-B



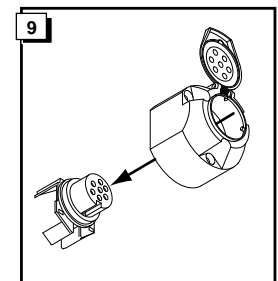
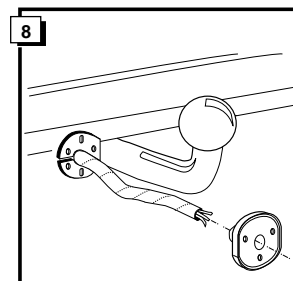
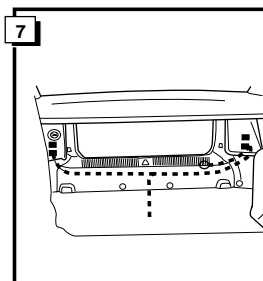
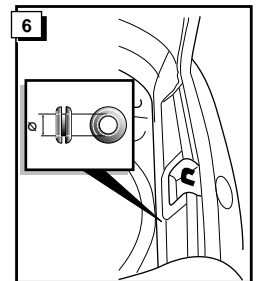
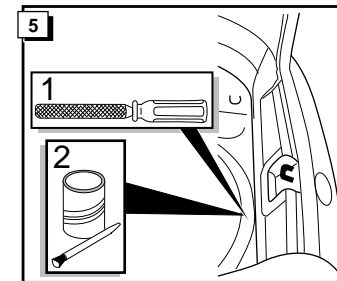
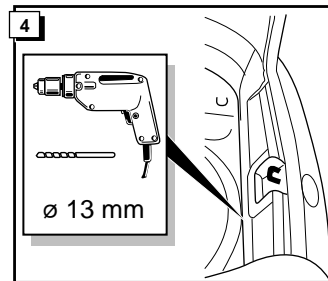
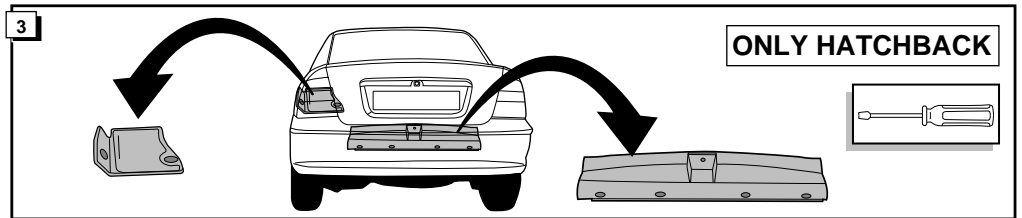
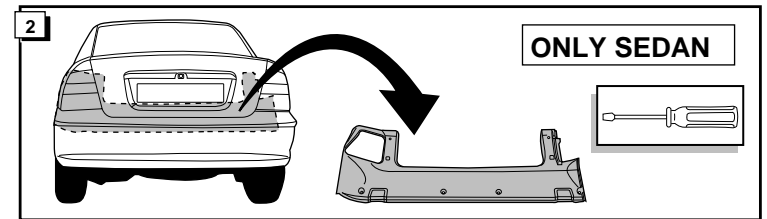
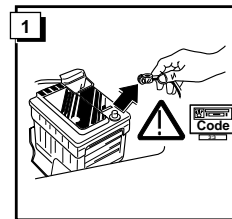
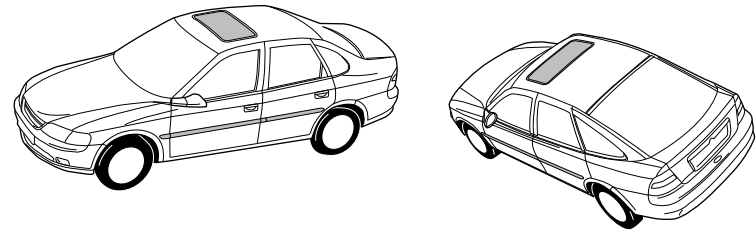

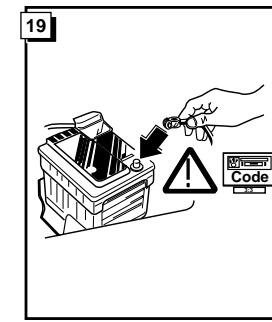
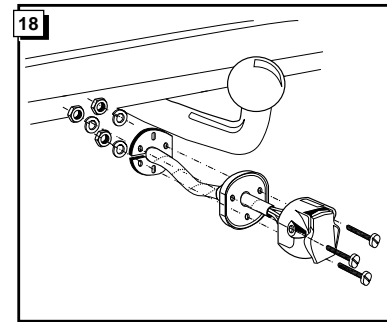
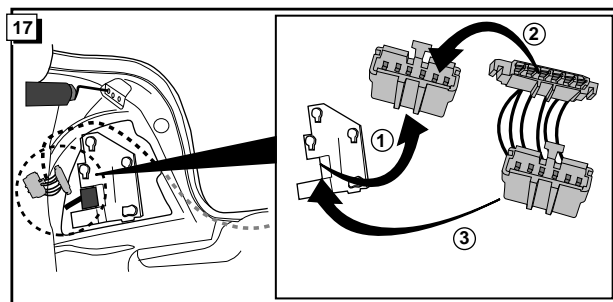
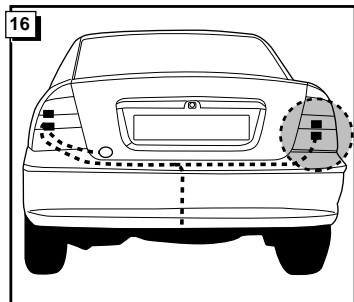
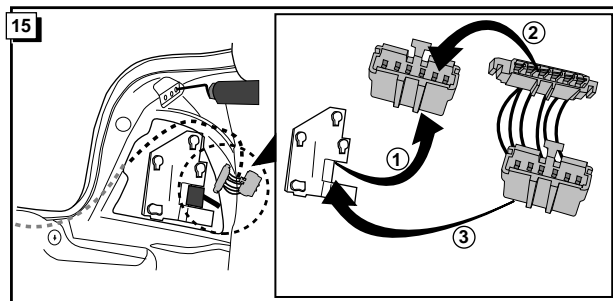
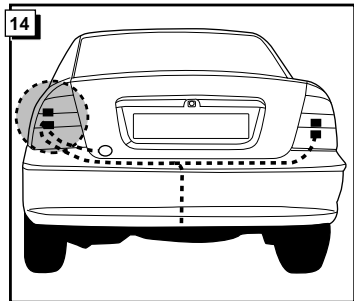
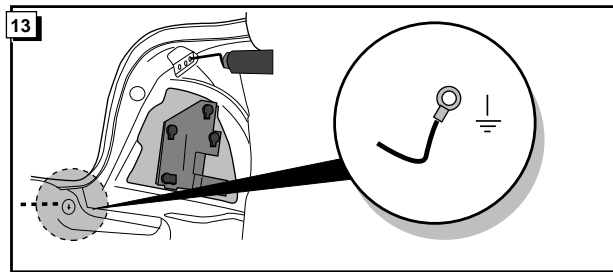
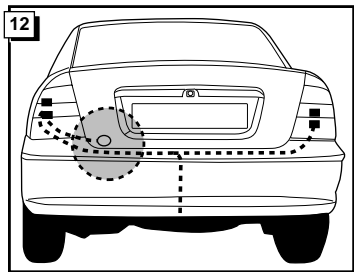
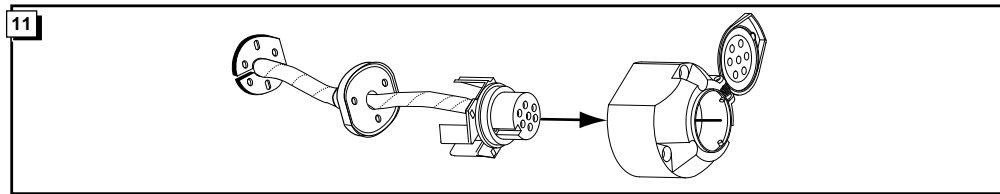
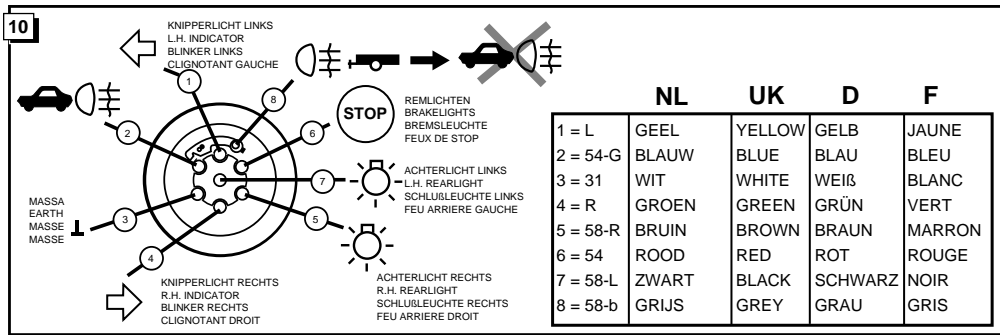

**20**

**CONTROLEER FUNCTIES !**  
**CHECK FUNCTIONS !**  
**FUNKTIONEN KONTROLIEREN !**  
**CONTRÔLER LES FONCTIONS !**

