

**Einbauanleitung Elektrosatz
Anhängervorrichtung mit 13-P Steckdose
lt. DIN/ISO Norm 11446**

**Instructions de montage du faisceau
électrique pour crochet d'attelage
conforme à la norme
DIN/ISO 11446 prise 13-P**

**Fitting instructions electric wiringkit
towbar with 13-P socket up to
DIN/ISO norm 11446**

**Montage-handleiding elektrokabelset voor
trekhaak met 13-P contactdoos
vigs. DIN/ISO norm 11446**

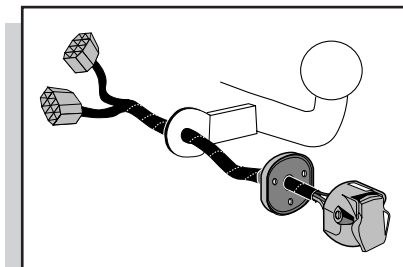

NISSAN ALMERA HB 2000-/2003-

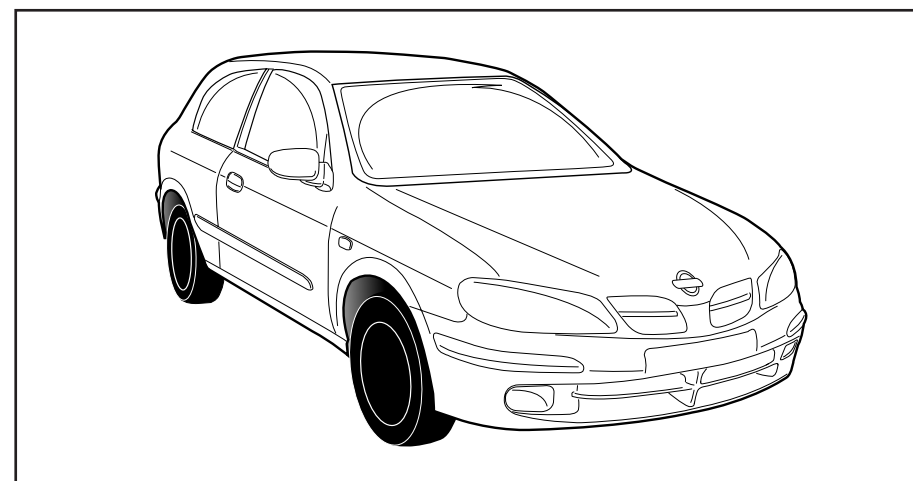

Bestel Nr.: NI-014-DL

* Teilliste

* Liste de pieces

* Part list

* Onderdelenlijst

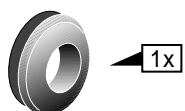
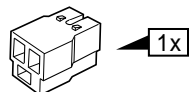
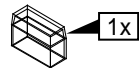
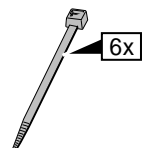
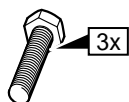
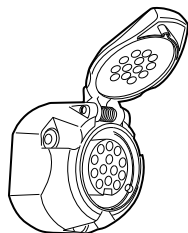
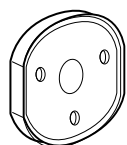
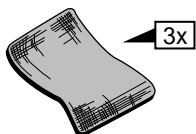
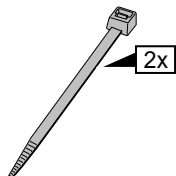
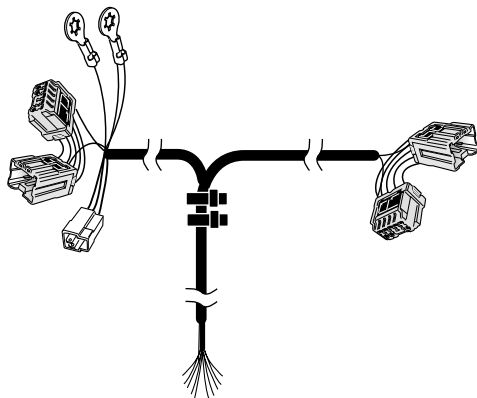
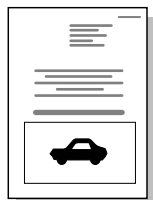
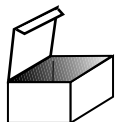

INFO

Dieses Fahrzeug ist mit einem akustischen Signal versehen, das bei angeschlossenem Anhänger die Wirkung der Blinkleuchten überprüft (3x21W).

Cette véhicule a un signal acoustique, qui contrôle le fonctionnement des clignotants (3x21W) quand la remorque est accouplée.

This vehicle is equipped with an acoustic signal that checks functioning of the direction indicator (3x21W) with the trailer connected.

Dit voertuig is uitgevoerd met een akoestisch signaal dat bij aangesloten aanhanger de werking van de knipperlichten controleert (3x21W).

1

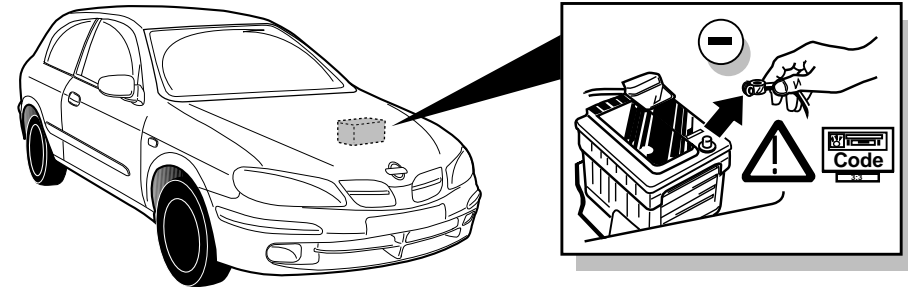

2

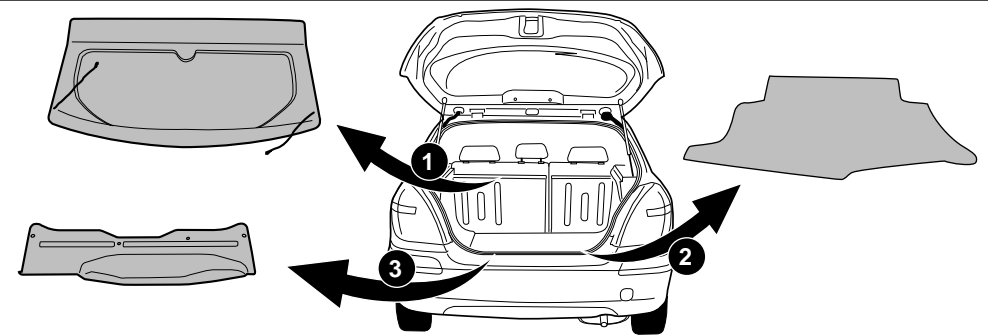

3

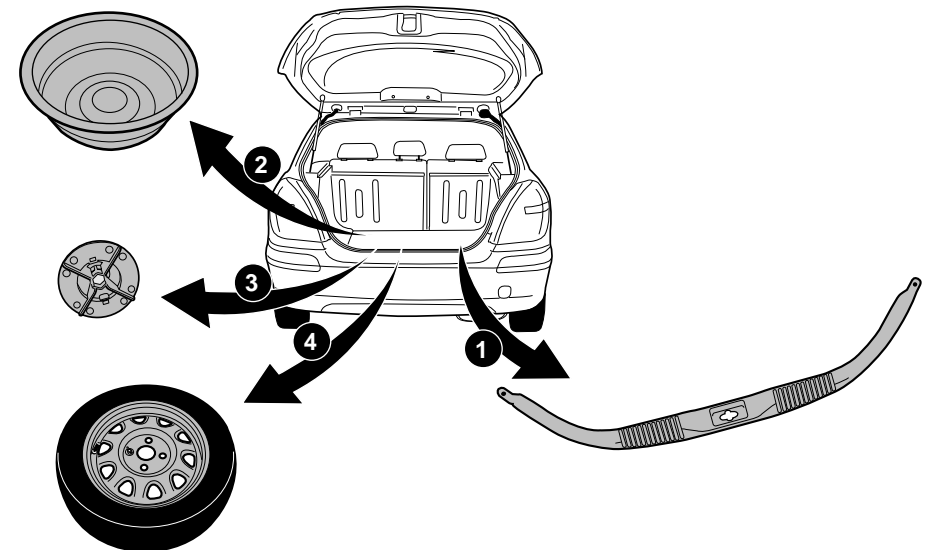

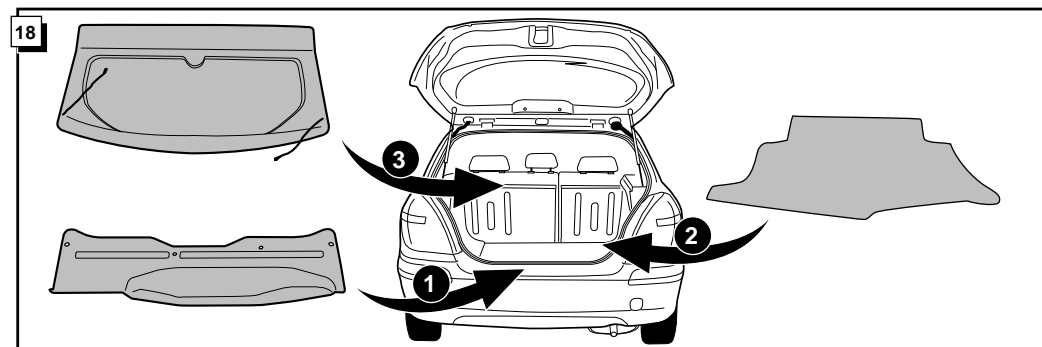
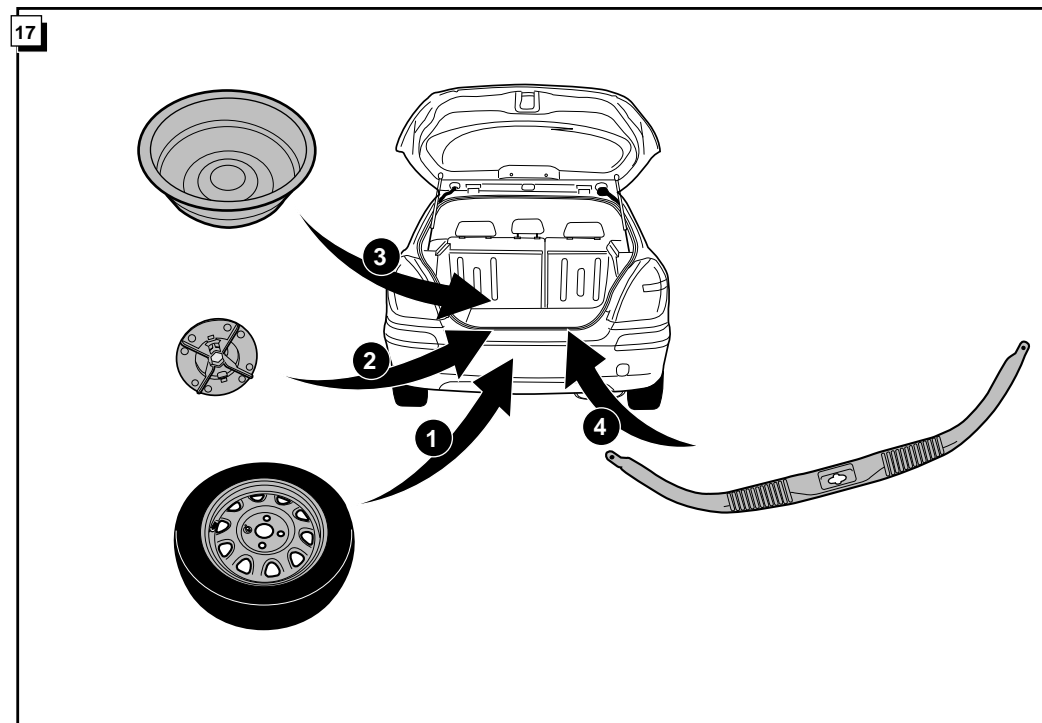
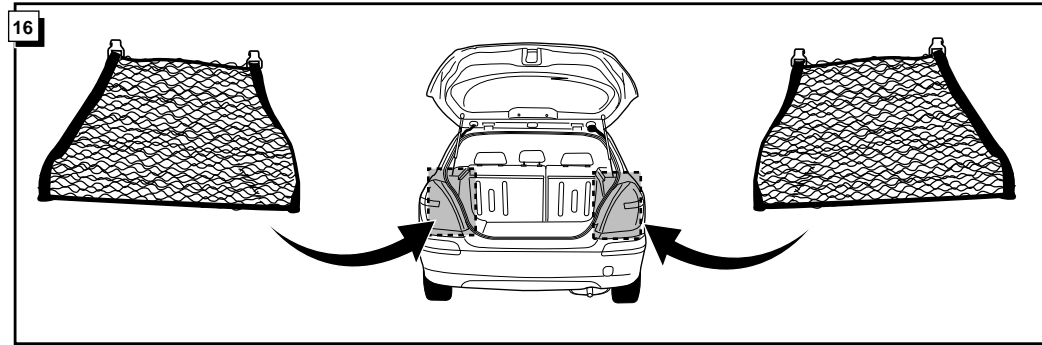
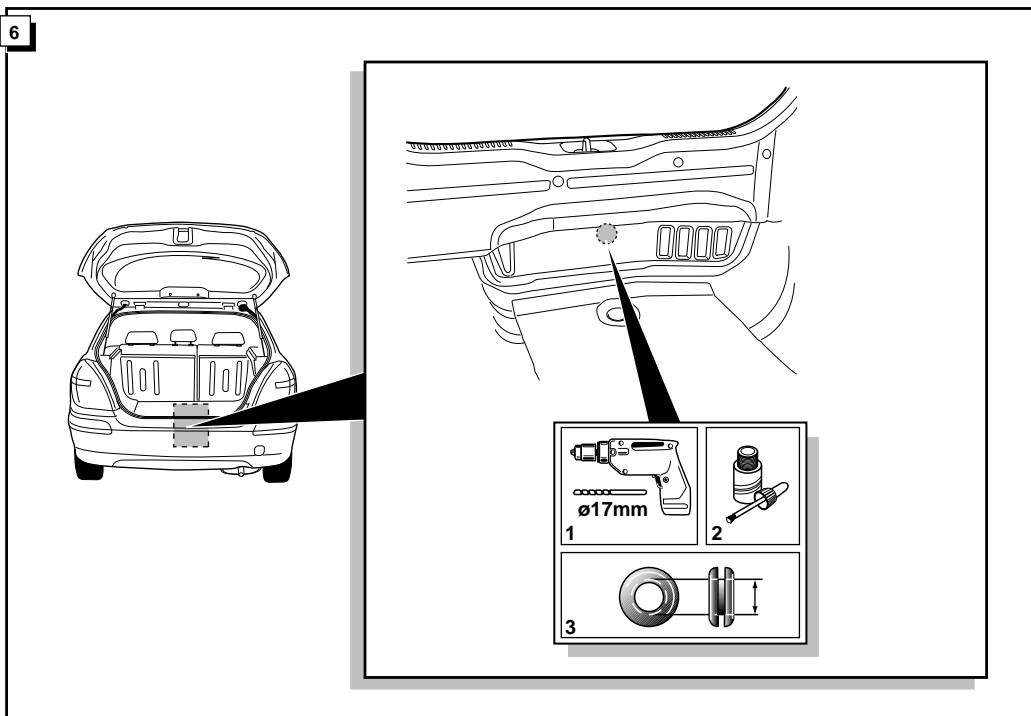
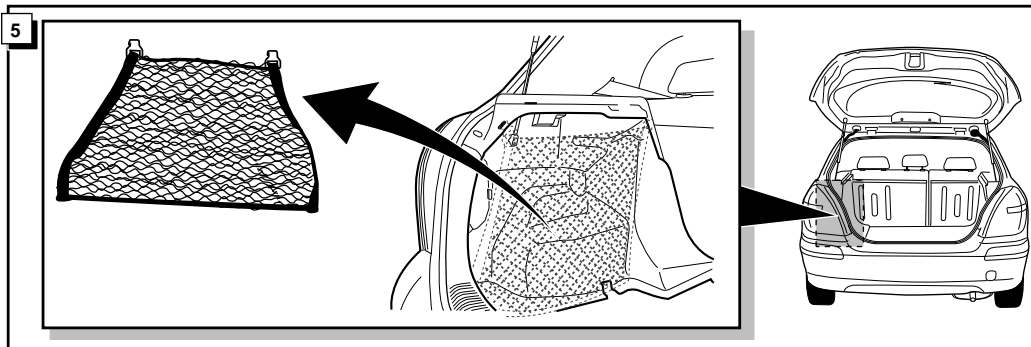
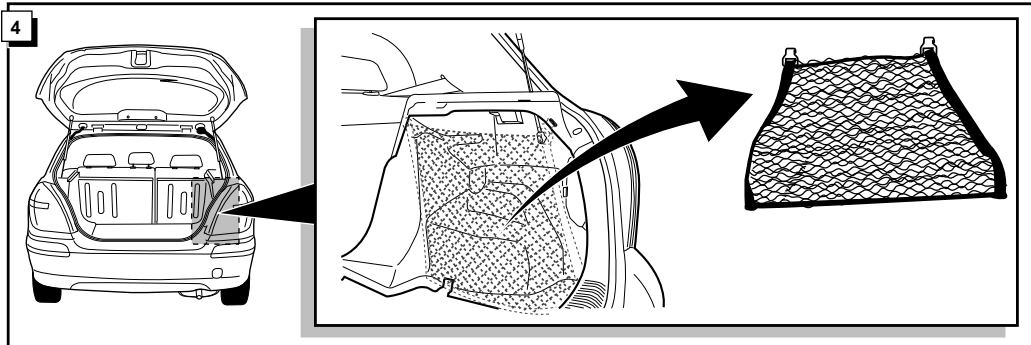

12

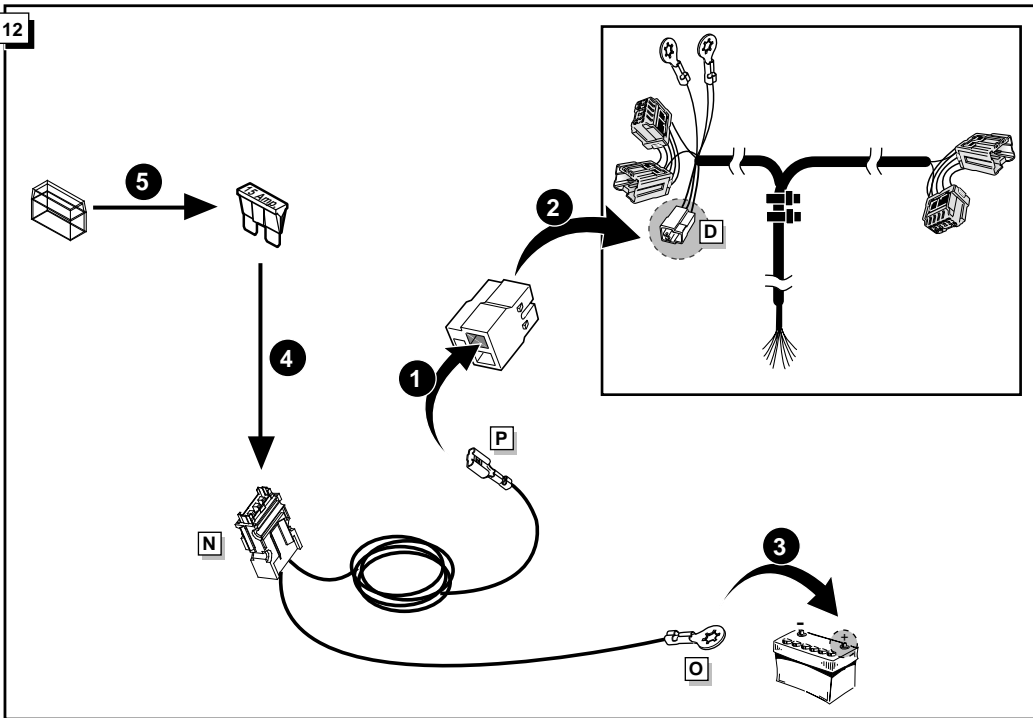

INFO

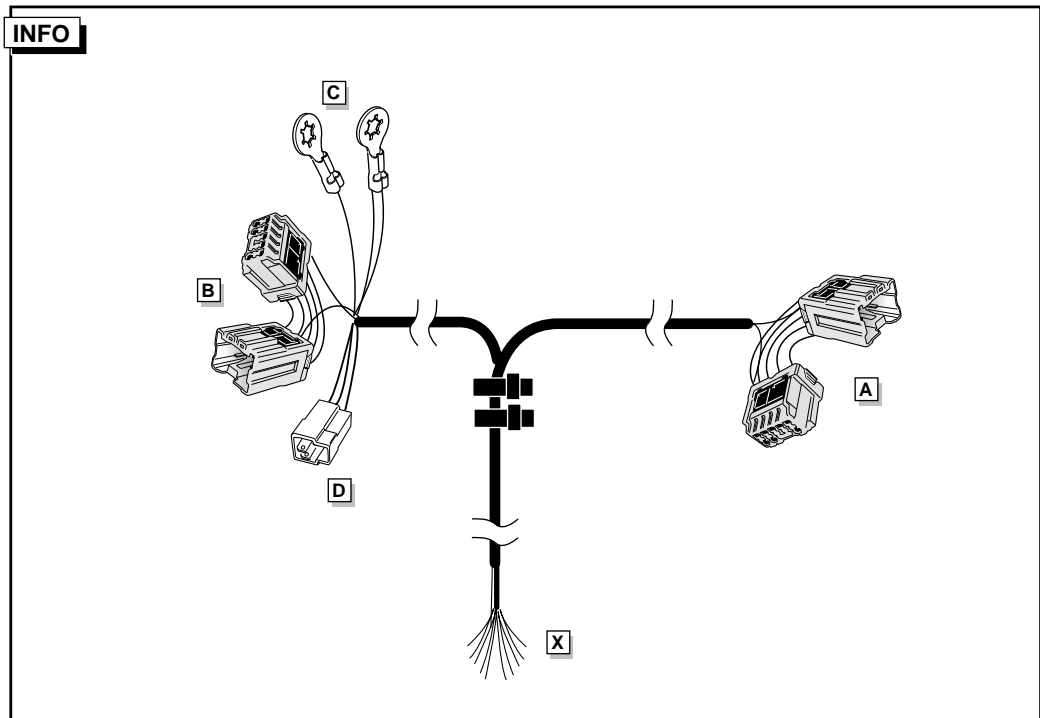

13

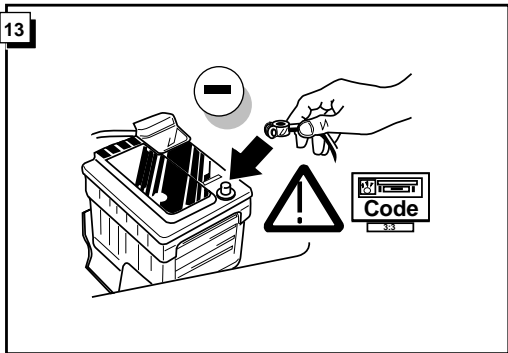

14

! FUNKTIONEN KONTROLLIEREN !
! CONTRÔLER LES FONCTIONS !
! CHECK FUNCTIONS !
! CONTROLEER FUNCTIES !

15

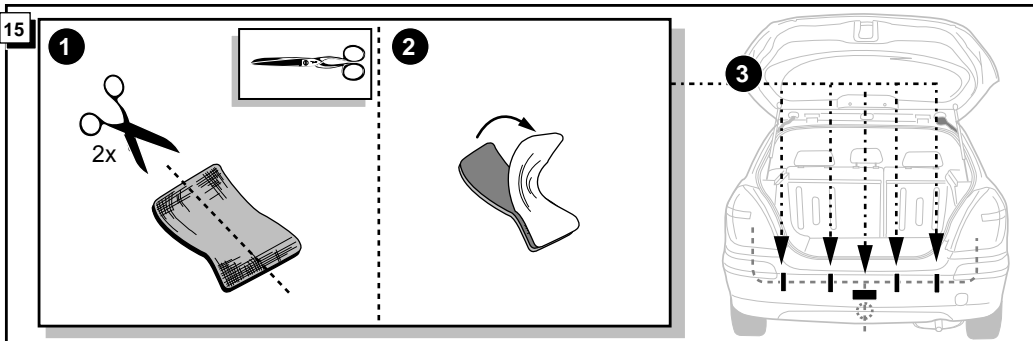

ROUTING

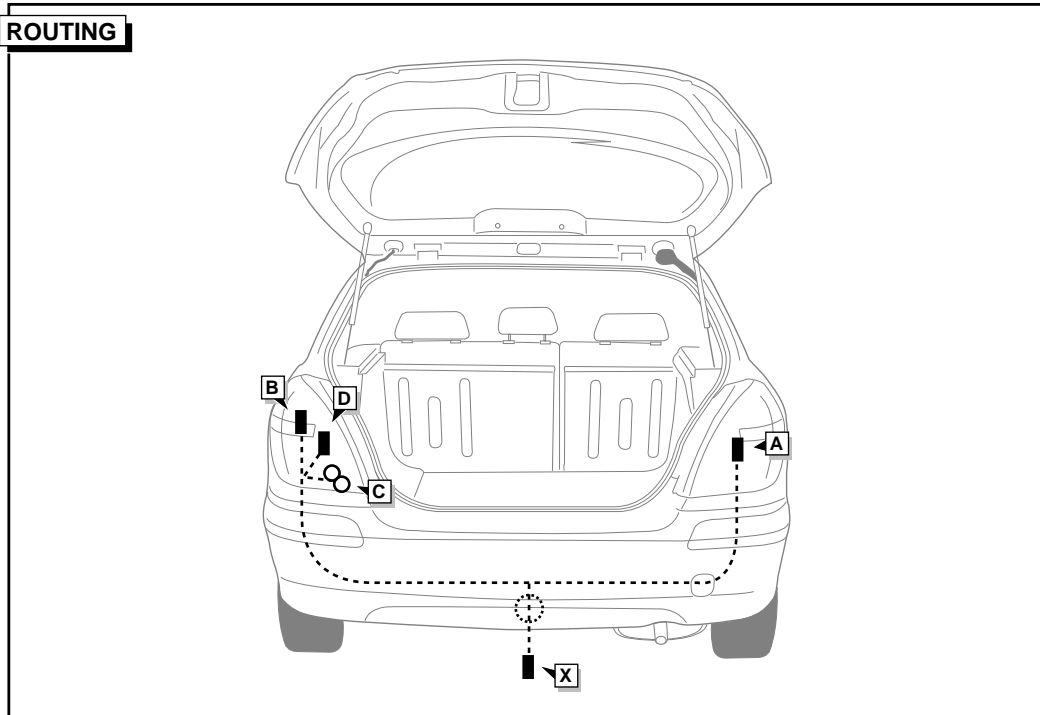

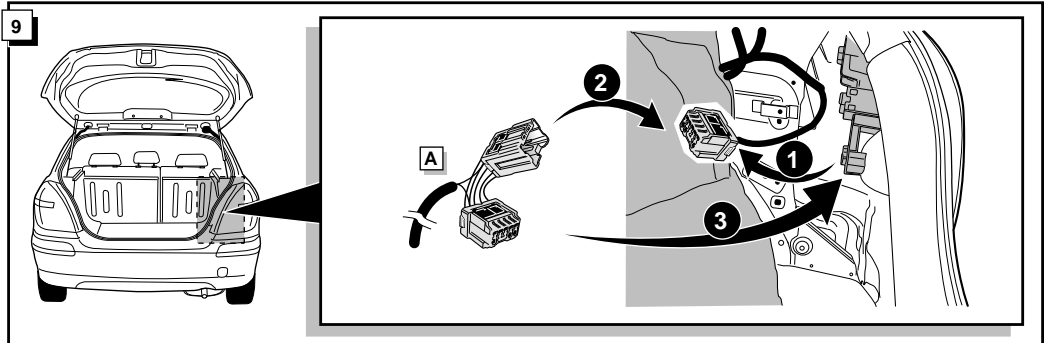
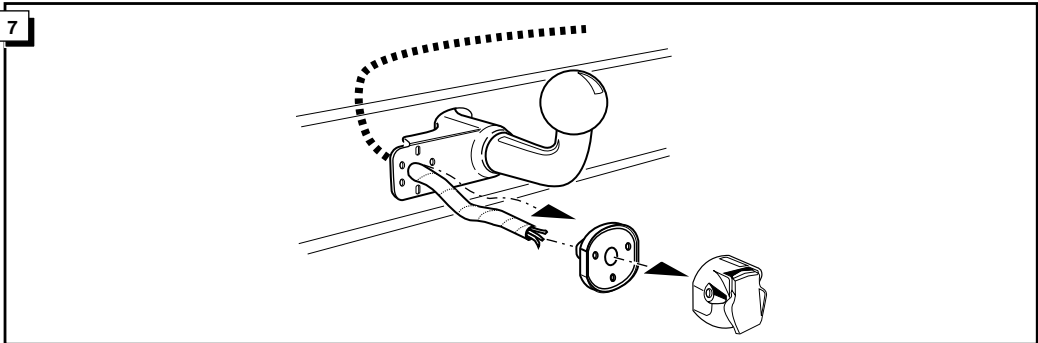

INFO Anschluß Steckdose / Connection de la prise / Socket connection / Contactdoos aansluiting

| DIN/ISO 11446 | | (D) | (F) | (GB) | (NL) |
|---------------|--------|-------------|--------------|-------------|------------|
| | 1/L | gelb | jaune | yellow | geel |
| | 2 | blau | bleu | blue | blauw |
| | 2a | grau | gris | grey | grijs |
| | 3/31 | weiß | blanc | white | wit |
| | 4/R | grün | vert | green | groen |
| | 5/58-R | braun | marron | brown | bruin |
| | 6/54 | rot | rouge | red | rood |
| | 7/58-L | schwarz | noir | black | zwart |
| | 8 | schwarz/rot | noir/rouge | black/red | zwart/rood |
| | 9 | braun/weiß | marron/blanc | brown/white | bruin/wit |
| | 10 | rot | rouge | red | rood |
| | 11 | weiß | blanc | white | wit |
| | 12 | rot/blau | rouge/bleu | red/blue | rood/blauw |
| | 13 | weiß | blanc | white | wit |

