

Land Rover Freelander II 02/2007-

Partnr.: LR-002-B1U

- Fitting instructions electric wiring kit tow bar with 12-N socket up to DIN/ISO Norm 1724.
- We would expressly point out that assembly not carried out properly by a competent installer will result in cancellation of any right to damage compensation, in particular those arising by virtue of the product liability act.
- Contents of these kits and their fitting manuals are subject to alteration without notice, please ensure that these instructions are read and fully understood before commencing installation.
- Do not overload circuits; the maximum loads per connection are detailed in this manual.
- Attention! Before Installation, please read this manual carefully and inform your customer to consult the vehicle owners manual to check for any vehicle modifications required before towing.
- In the event of functional problems, troubleshooting must be limited to about 0.5 hours, contact the technical support:
t.skinner@ecs-electronics.com / 07440 202 052.



Part list

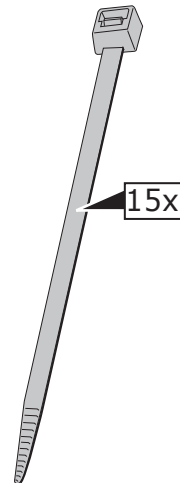
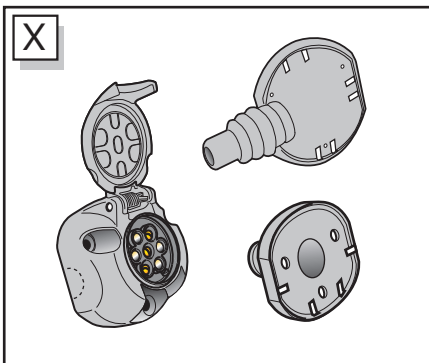
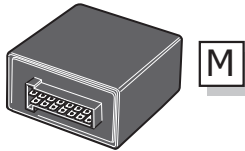
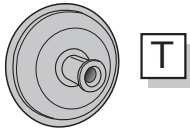
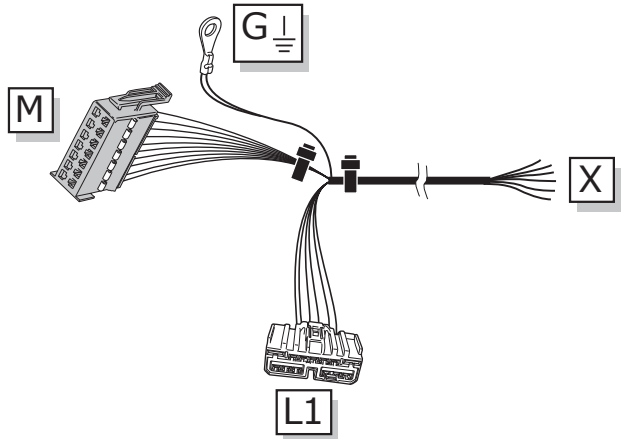
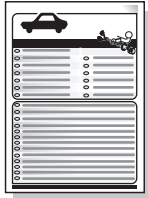
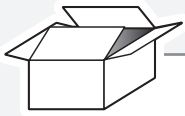

UN-243-YZ
Optional reverse lamp
pre-wire extension included

Pag. 10

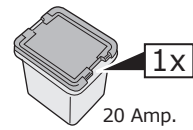
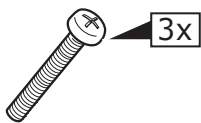

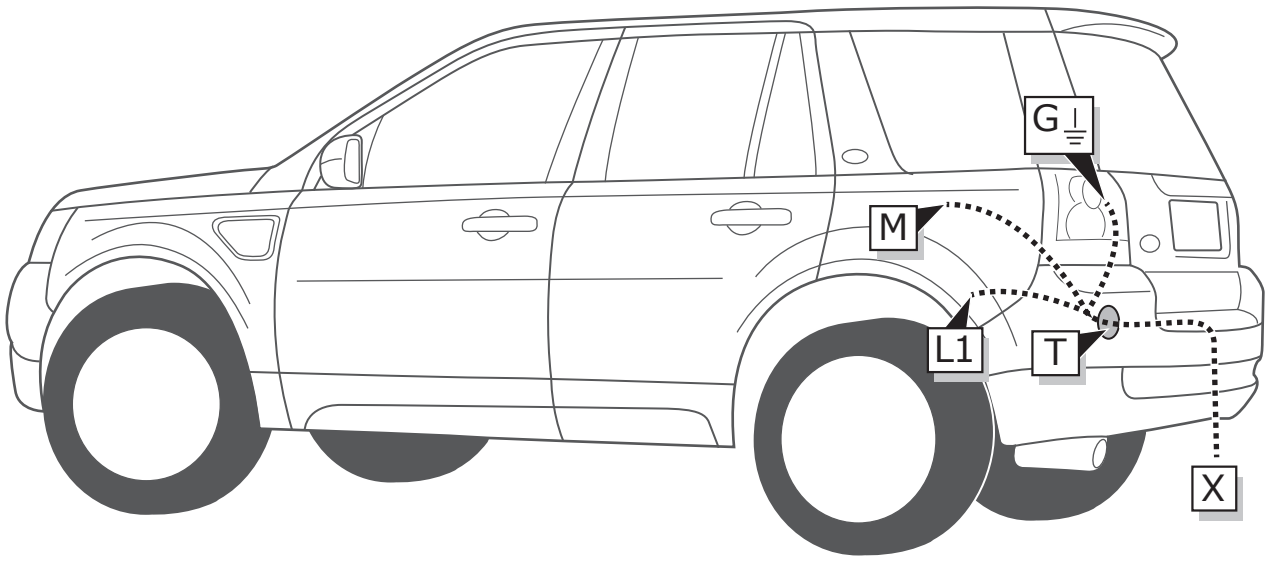

1

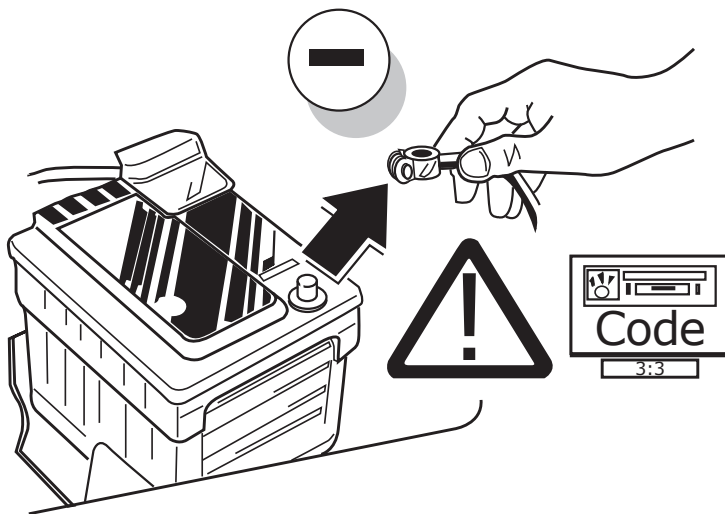

2

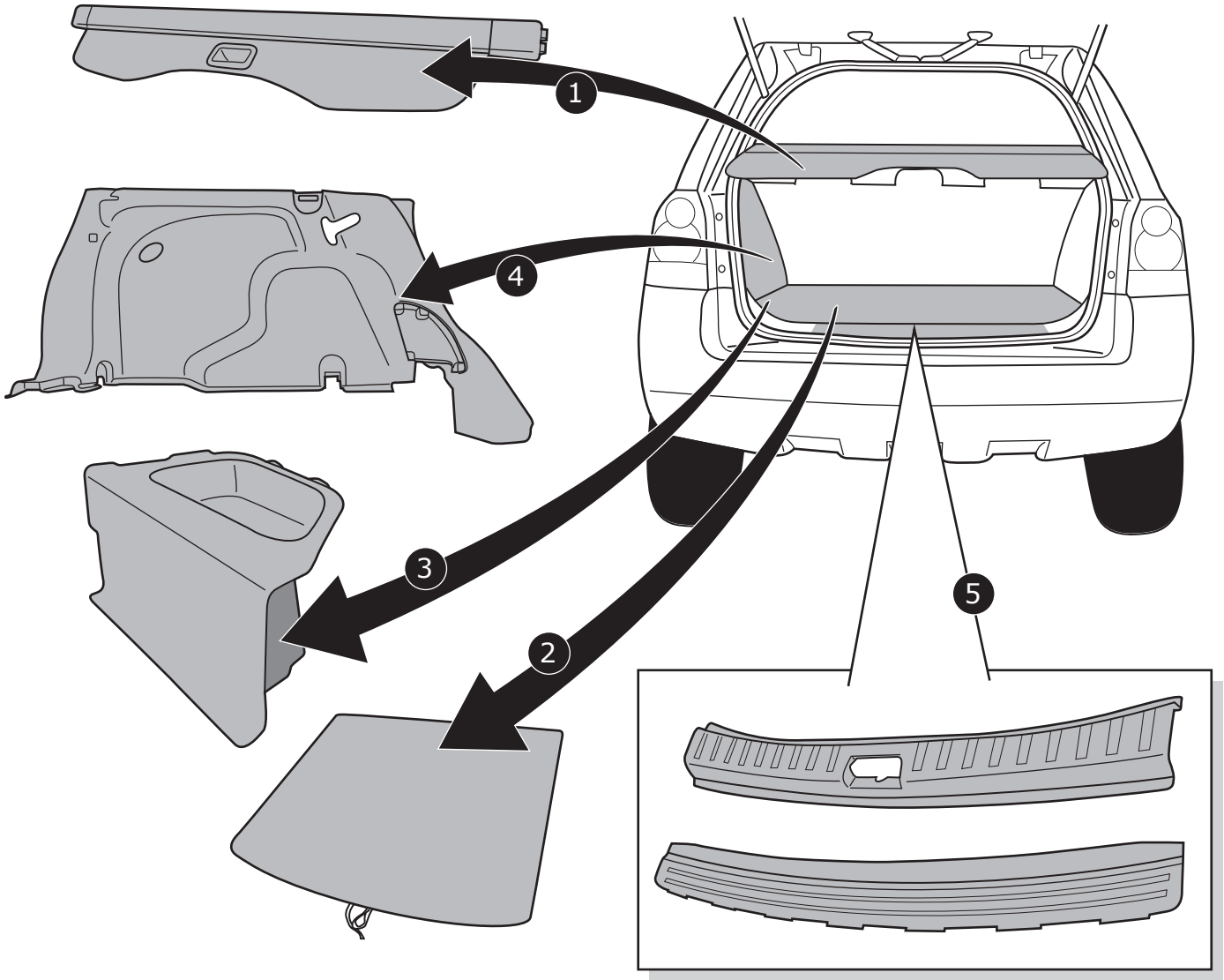

3

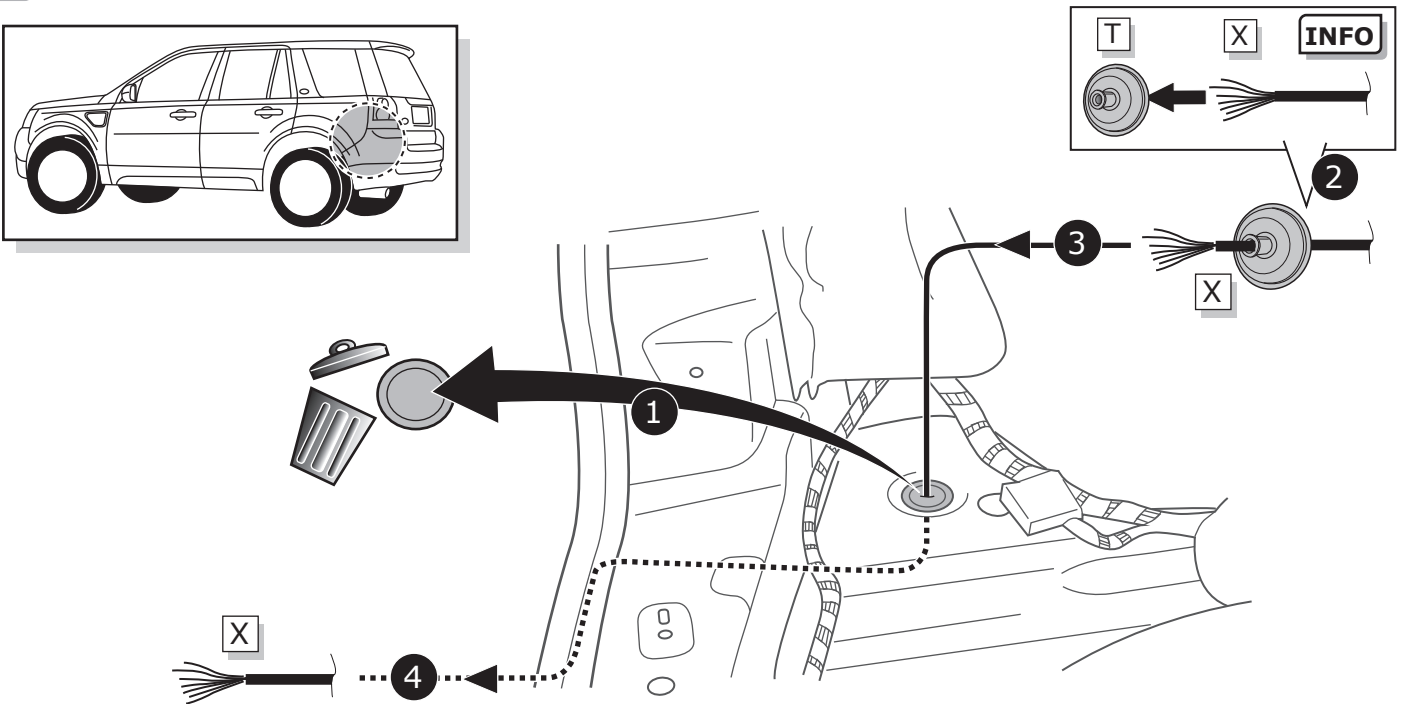

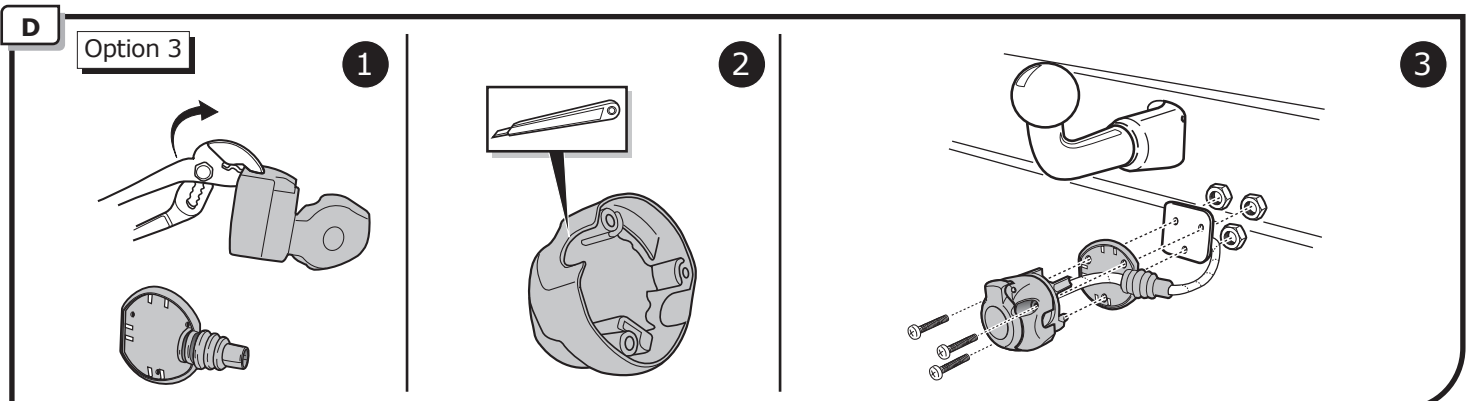
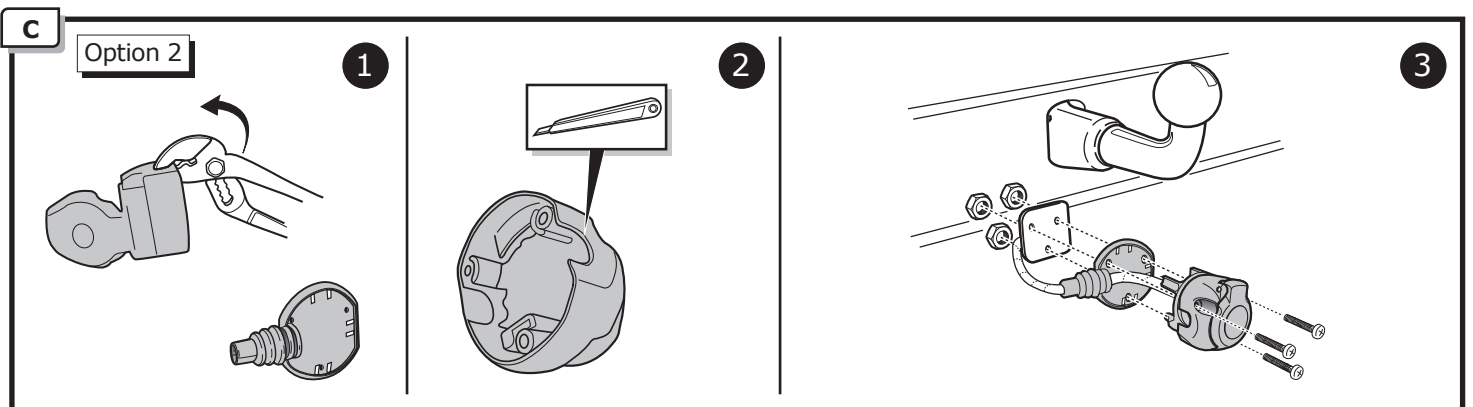
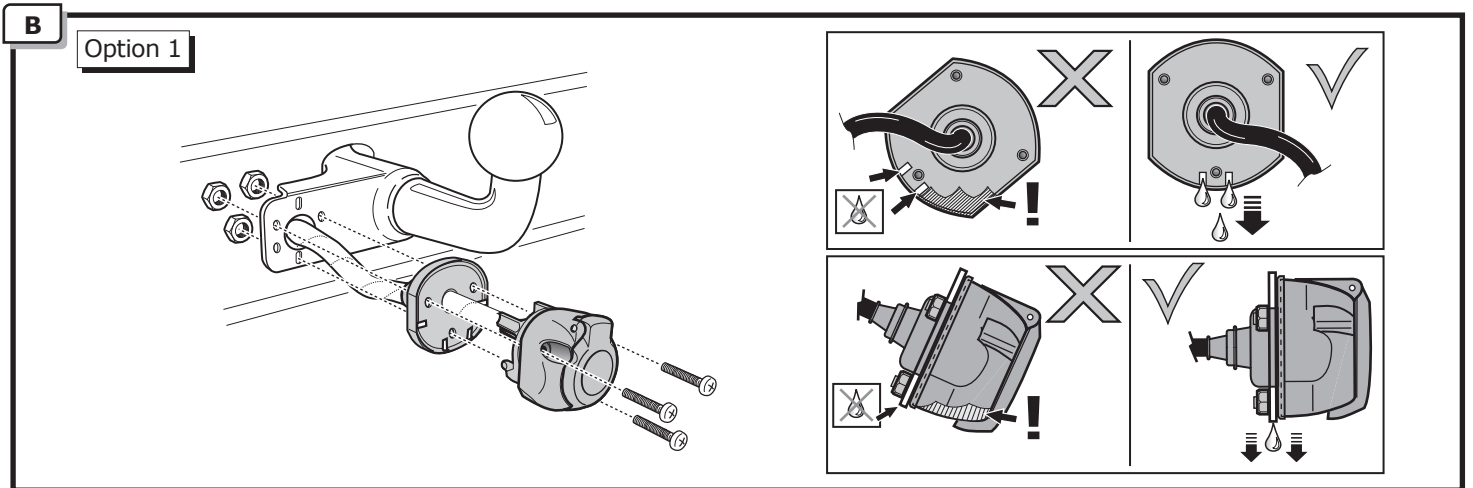
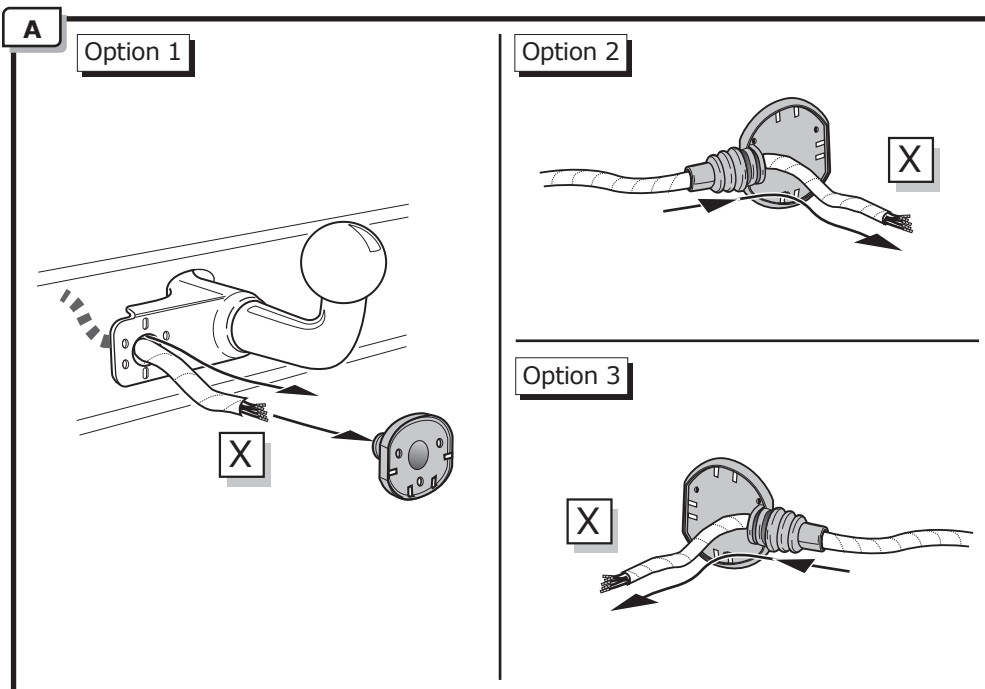

4

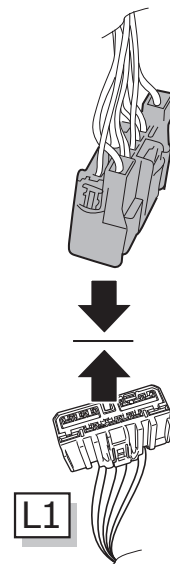
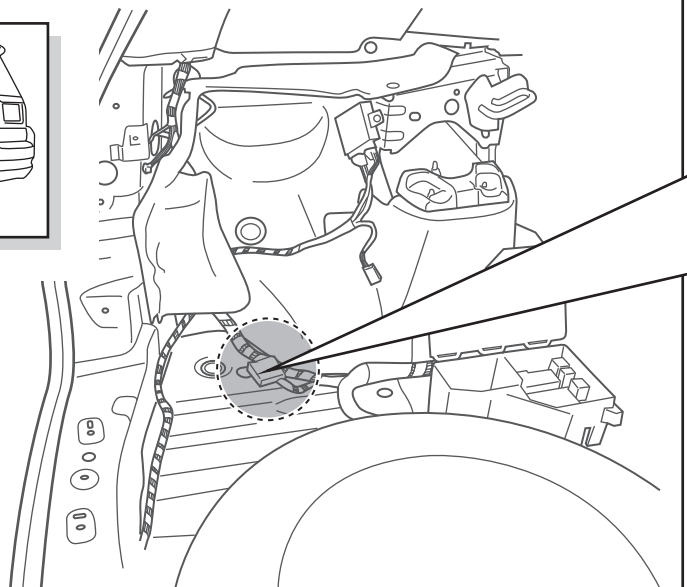
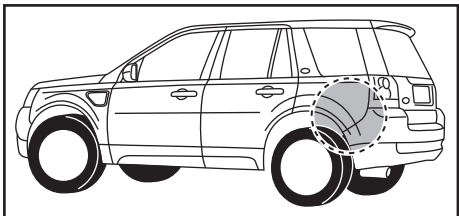

5

1

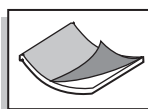

2

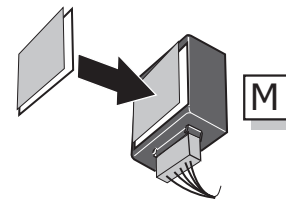

3

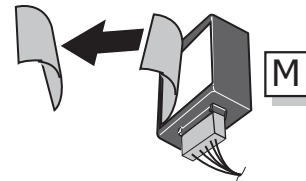

4

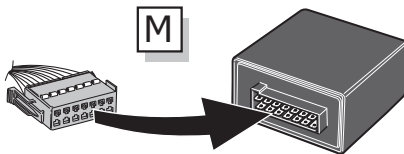

6

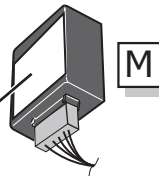
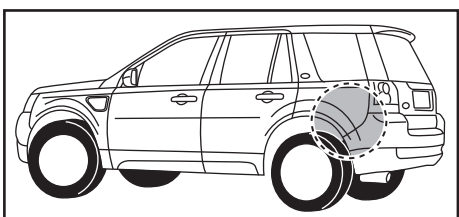

1

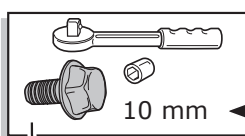

2

3

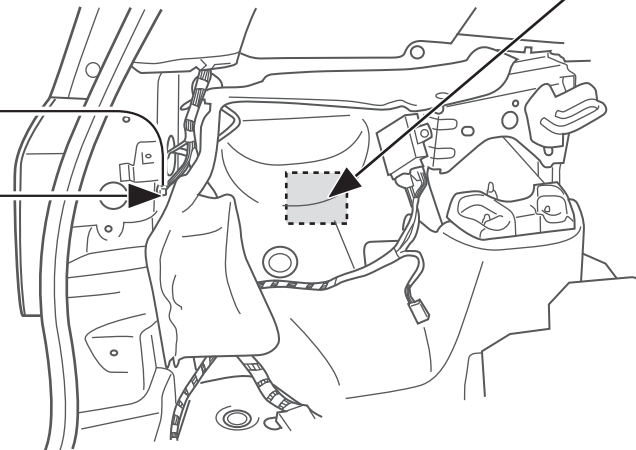

7

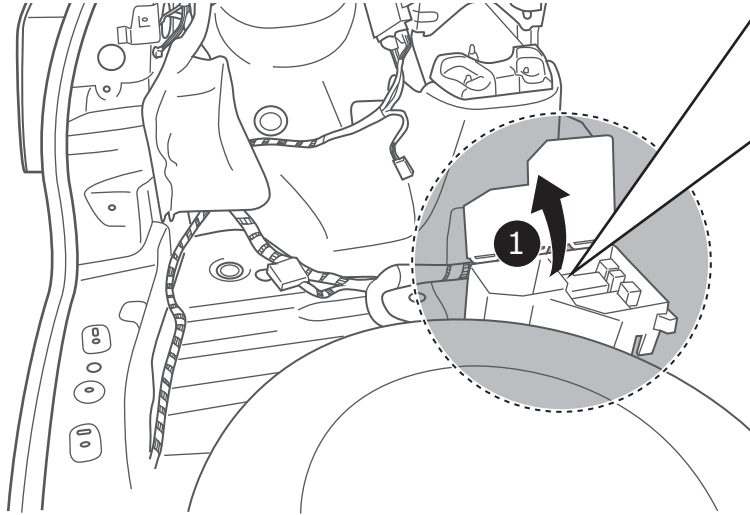
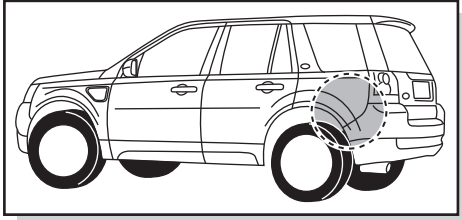

2

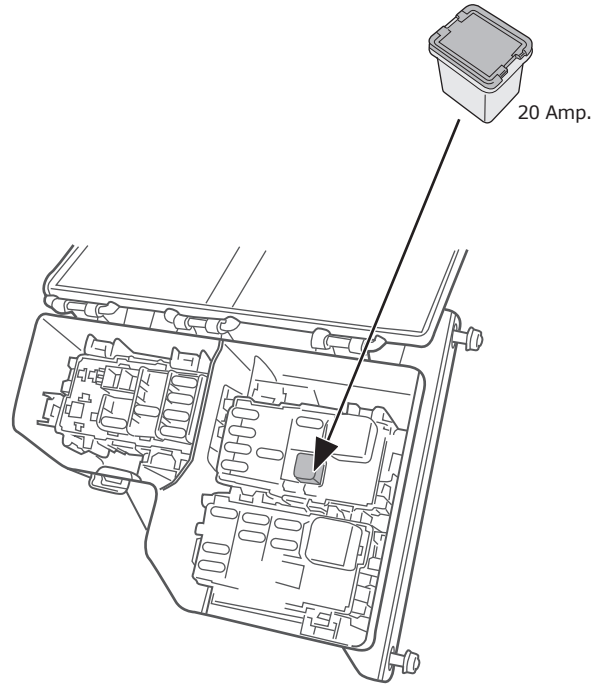

8

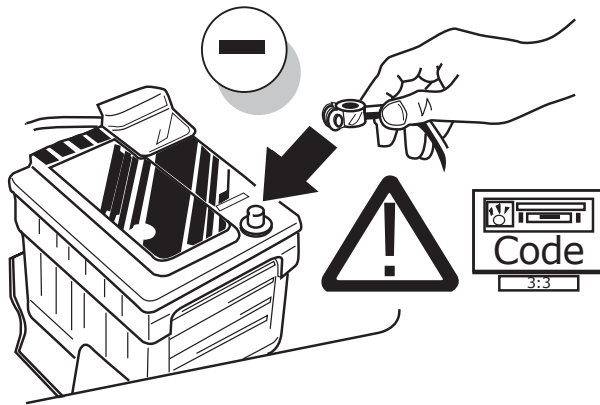

9

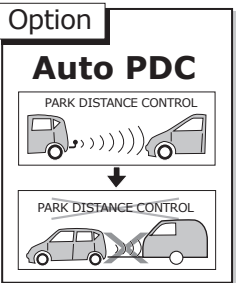

! TEST ALL THE CIRCUITS WITH A TEST DEVICE WITH THE CORRECT POWER LOAD FOR EACH FUNCTION. A TEST DEVICE WITH LED'S CANNOT BE USED FOR THIS PURPOSE.

INFO

REINSTALL TRIM.

INFO

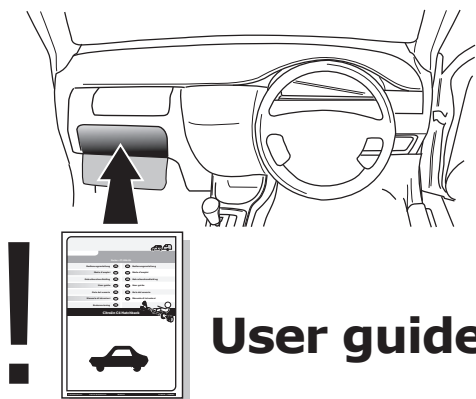

INFO



INFO



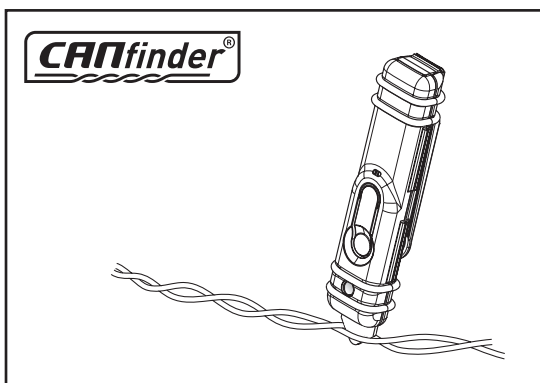

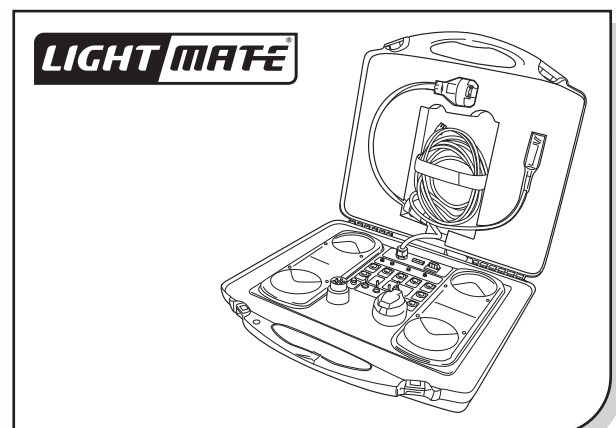

Products & Service



http://www.ecs-electronics.nl/NL/catalogus/test_gereedschap

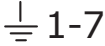

SOCKET CONNECTION

DIN/ISO 1724							
	1/L	2	3/31	4/R	5/58-R	6/54	7/58-L
Pmax	21W	21W		21W	42W	3x21W	42W
Colour	Yellow	Blue	White	Green	Brown	Red	Black

UN-243-YZ Reverse lamp pre-wire extension

⚠ MAX = 21W

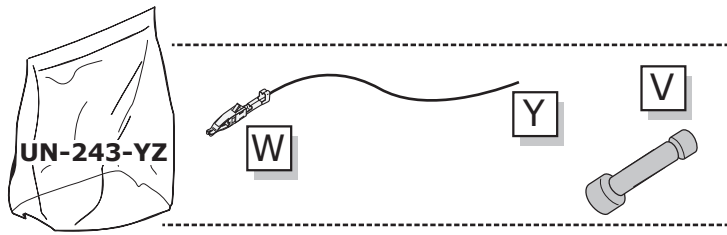

A

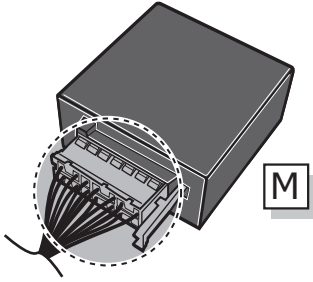

1

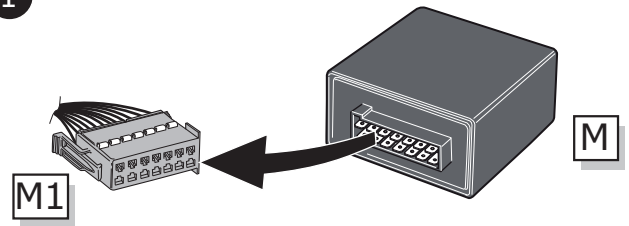

2

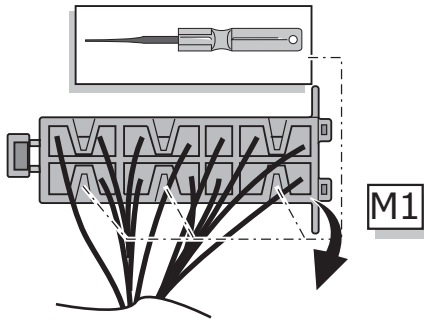

3

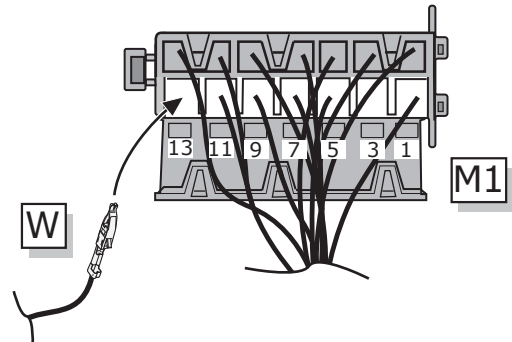

4

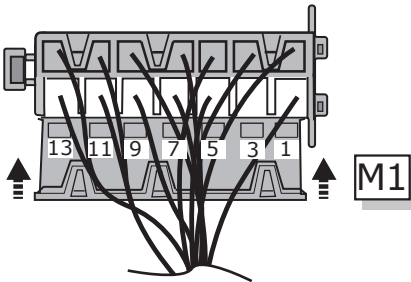

5

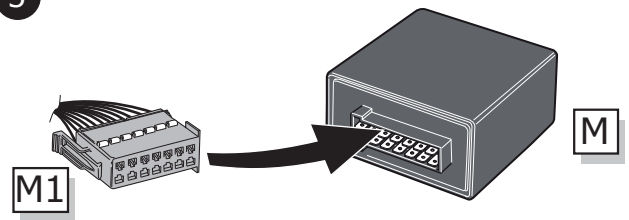

B

⚠ MAX = 21W

