

- DE Gebrauchsanleitung
- FR Mode d'emploi
- NL Gebruikershandleiding
- GB User guide
- ES Guía del usuario
- IT Manuale di istruzioni
- SE Bruksanvisning
- CZ Uživatelská příručka
- DK Brugervejledning
- FI Käyttöohjeet
- GR Οδηγός χρήστη
- NO Brukerveiledning
- PL Instrukcja obsługi

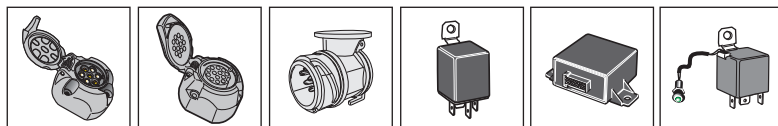

SPARE PARTS

www.ecs-electronics.com

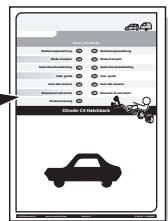

Partnr.: KI-038-DL

Gebrauchsanleitung (DE)	(CZ) Uživatelská příručka
Mode d'emploi (FR)	(DK) Brugervejledning
Gebruikershandleiding (NL)	(FI) Käyttöohjeet
User guide (GB)	(GR) Οδηγός χρήστη
Guía del usuario (ES)	(NO) Brukerveiledning
Manuale di istruzioni (IT)	(PL) Instrukcja obsługi
Bruksanvisning (SE)	

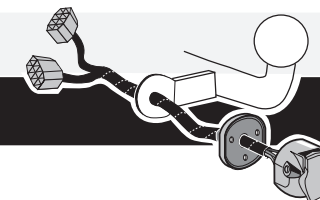

Kia Cerato 2007-

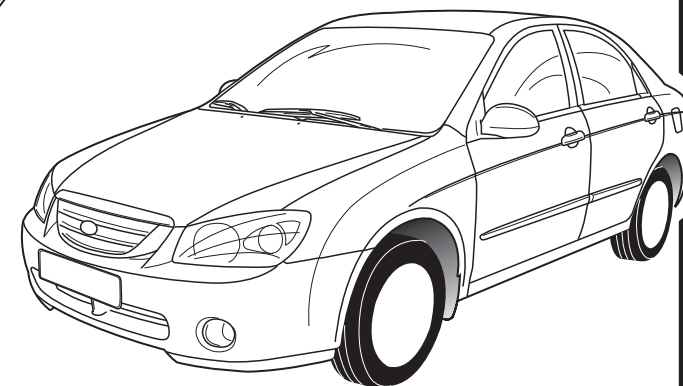
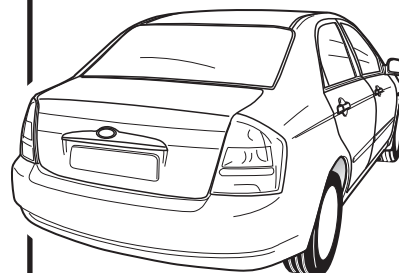

DE Anschluss Steckdose
FR Connection de la prise
NL Contactdoos aansluiting
GB Socket connection

ES Conexión de la caja de enchufe
IT Allaccio zoccolo
SE Anslutning kontaktbox

CZ Objímkový konektor
DK Stikdåse forbindelse
FI Pistorasia liitäntä

GR Υποδοχή σύνδεσης
NO Tilkobling koblingsboks
PL Połączenie przez gniazdo

DIV/ISO 11446	1/L 21W	2 2x21W	2a	1-8	4/R 21W	5/58-R 52W	6/54 3x21W	7/58-L 52W	8 2x21W	9 180W/15Amp	10 180W/15Amp	10	11	12	9
DE	Gelb	Blau	Grau	Weiß	Grün	Braun	Rot (1,00mm ²)	Schwarz	Schwarz/ Rot	Braun/ Weiß	Rot (2,50mm ²)	Weiß	Rot/ Blau	—	—
FR	Jaune	Bleu	Grís	Blanc	Vert	Marron	Rouge (1,00mm ²)	Noir	Noir/ Rouge	Marron/ Blanc	Rouge (2,50mm ²)	Blanc	Rouge/ Bleu	—	13
NL	Geel	Blauw	Grijs	Wit	Groen	Bruin	Rood (1,00mm ²)	Zwart	Zwart/ Rood	Bruin/ Wit	Rood (2,50mm ²)	Wit	Rood/ Blauw	—	—
GB	Yellow	Blue	Grey	White	Green	Brown	Red (1,00mm ²)	Black	Black/ Red	Brown/ White	Red (2,50mm ²)	White	Red/ Blue	—	—
ES	Amarillo	Azul	Grís	Blanco	Verde	Marrón	Rojo (1,00mm ²)	Negro	Negro/ Rojo	Marrón/ Blanco	Rojo (2,50mm ²)	Blanco	Rojo/ Azul	—	—
IT	Giallo	Blu	Grigio	Bianco	Verde	Marrone	Rosso (1,00mm ²)	Nero	Nero/ Rosso	Marrone/ Bianco	Rosso (2,50mm ²)	Bianco	Rosso/ Blu	—	—
SE	Gul	Blå	Grå	Vit	Grön	Brun	Röd (1,00mm ²)	Svart	Svart/ Röd	Brun/ Vit	Röd (2,50mm ²)	Vit	Röd/ Blå	—	—
CZ	Žlutá	Modrá	Šedá	Bílá	Zelená	Hnědá	Červená (1,00mm ²)	Černá	Černo/ Červená	Hnědo/ Bílá	Červená (2,50mm ²)	Bílá	Červená/ Modrá	—	—
DK	Gul	Blå	Grå	Hvid	Grøn	Brun	Rød (1,00mm ²)	Sort	Sort/ Rød	Brun/ Hvid	Rød (2,50mm ²)	Hvid	Rød/ Blå	—	—
FI	Keltainen	Sininen	Harmaa	Valkoinen	Vihreä	Ruskea	Punainen (1,00mm ²)	Musta	Musta/ Punainen	Ruskea/ Valkoinen	Punainen (2,50mm ²)	Valkoinen	Punainen/ Sininen	—	—
GR	Κίτρινο	Μπλε	Γκρι	Λευκό	Πράσινο	Καφέ	Κόκκινο (1,00mm ²)	Μαύο	Μαύο/ Κόκκινο	Καφέ/ Λευκό	Κόκκινο (2,50mm ²)	Λευκό	Κόκκινο/ Μπλε	—	—
NO	Gul	Blå	Grå	Hvit	Grønn	Brun	Rød (1,00mm ²)	Svart	Svart/ Rød	Brun/ Hvit	Rød (2,50mm ²)	Hvit	Rød/ Blå	—	—
PL	Żółty	Niebieski	Szary	Biały	Zielony	Brązowy	Czerwon (1,00mm ²)	Czarny	Czarny/ Czerwony	Brązowy/ Biały	Czerwony (2,50mm ²)	Biały	Czerwony/ Niebieski	—	—

- DE Sicherungen austauschen
- ES Cambio de fusible
- CZ Výměna pojistky
- GR Αλλαγή ασφάλειας
- FR Remplacer les fusibles
- IT Sostituire i fusibili
- DK Udskiifting af sikringer
- NO Skifte sikringene
- Zekeringen vervangen
- SE Byte av säkringar
- FI Vaihtaa varokkeet
- PL Wymienić bezpieczniki
- GB Changing the fuse

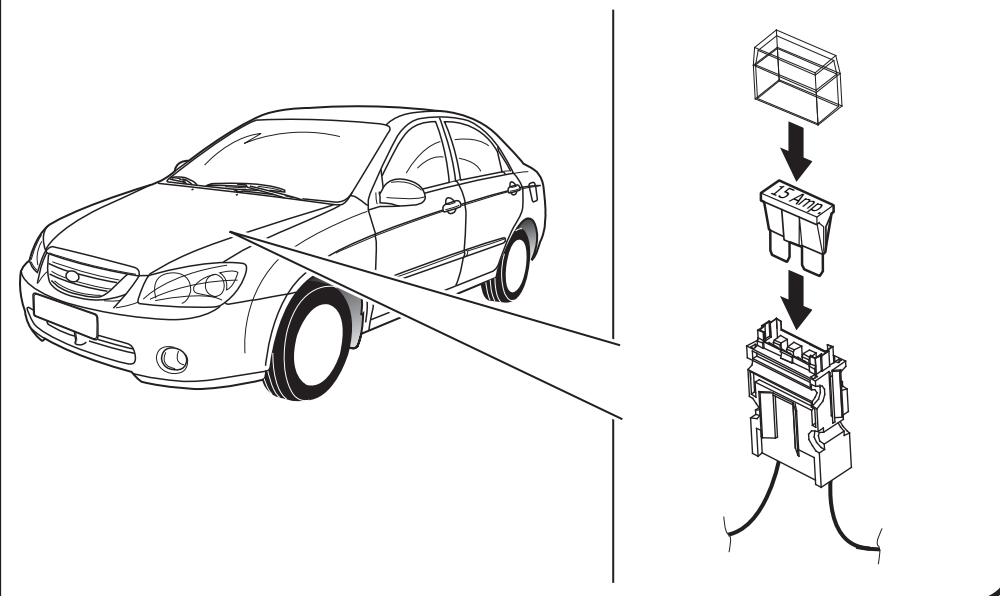

INFO : Storage

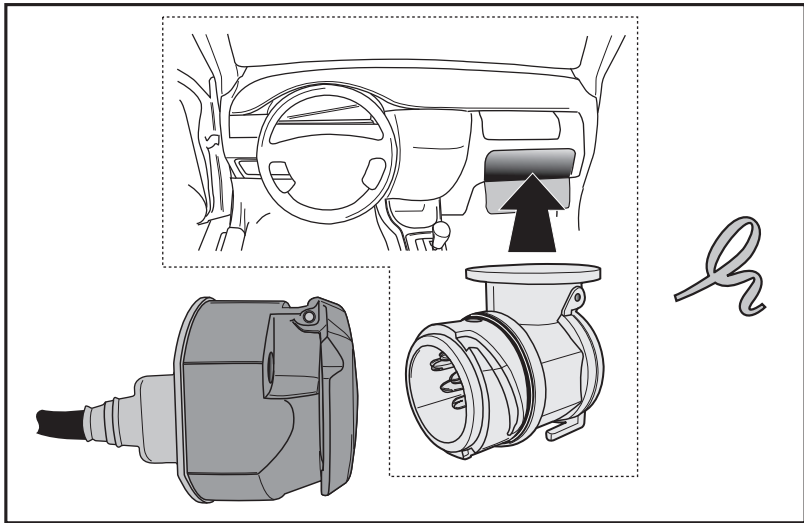
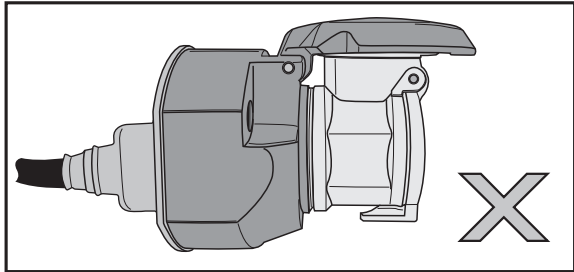
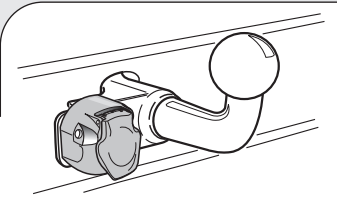
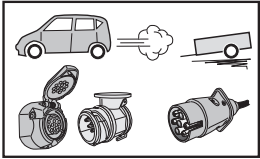

INFO

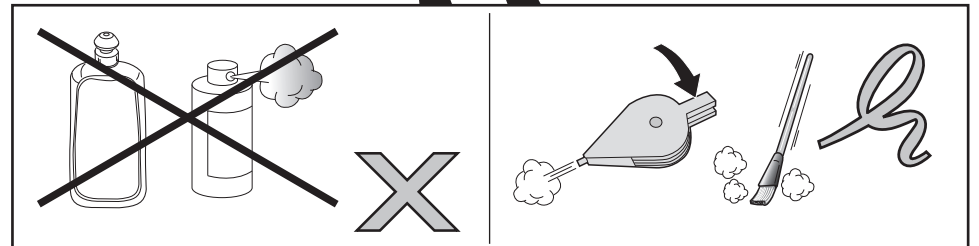
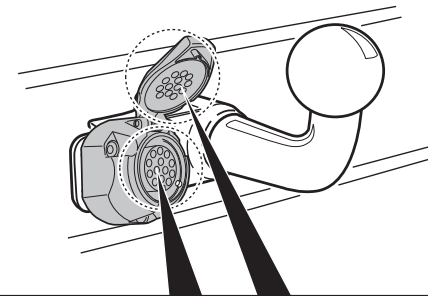
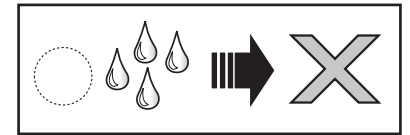
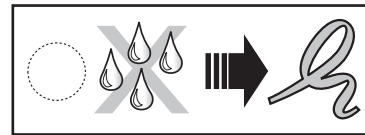
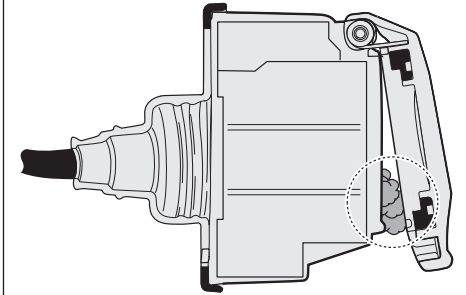
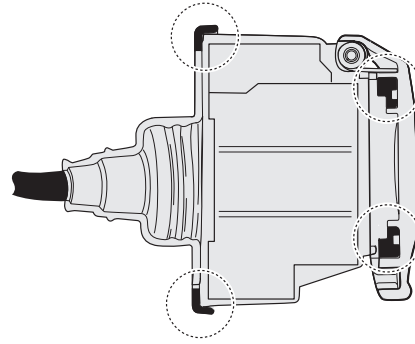
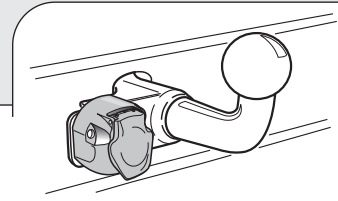
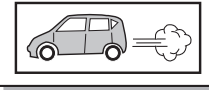

INFO : Ring.

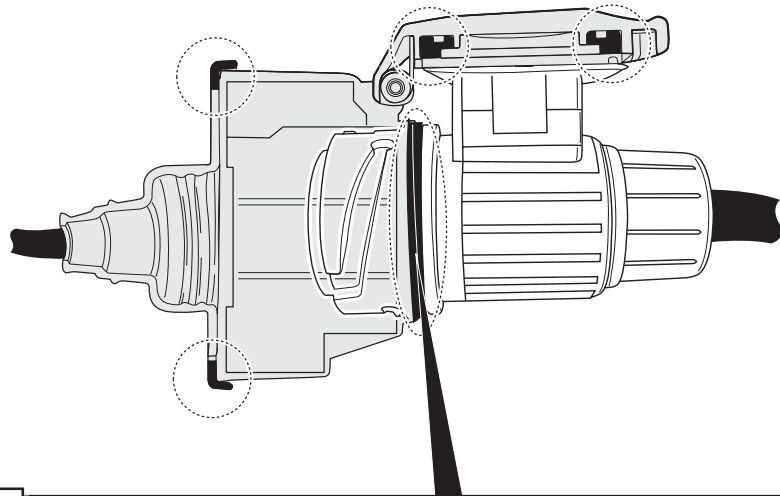
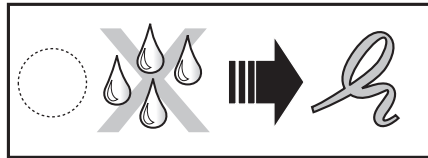
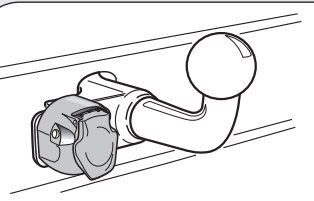
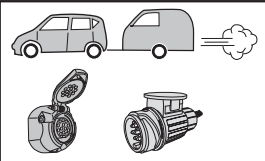

INFO

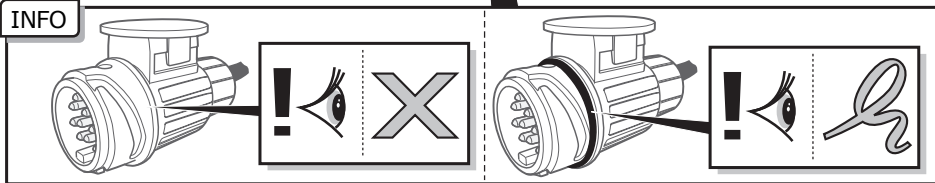

INFO : Adapt.

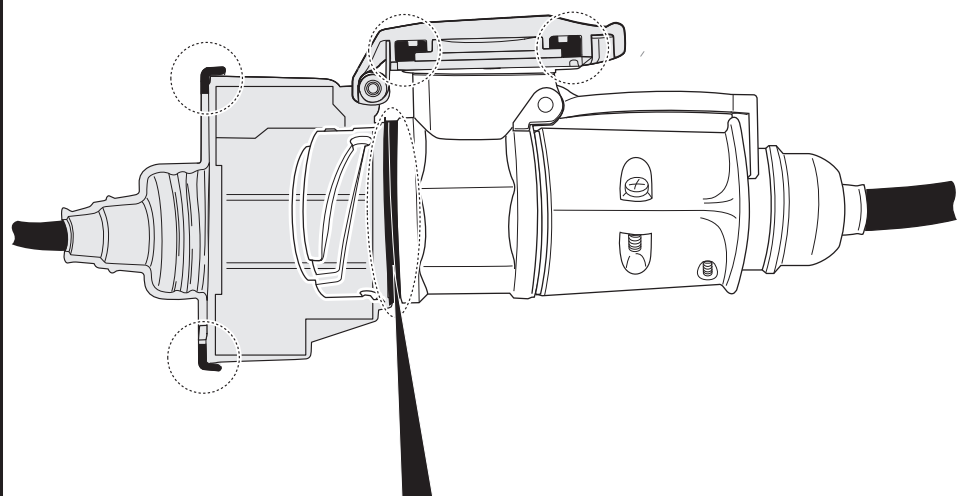
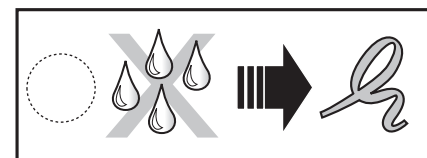
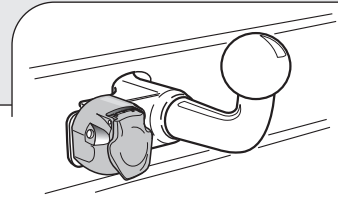
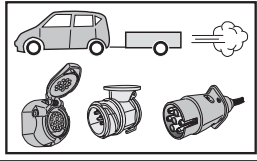

INFO

