

! INFO !

- (DE) Die Batterie des Zugfahrzeugs bzw. gezogenen Fahrzeugs nicht direkt über die Steckdose aufladen.
- (FR) Ne pas charger les batteries du véhicule tracteur et/ou tracté directement sur la prise de courant.
- (NL) De accu van het trekkend voertuig c.q. getrokken voertuig niet rechtstreeks via de contactdoos opladen.
- (GB) Do not charge the battery of the towing vehicle and/or towed vehicle directly via the socket.
- (ES) No recargue la batería del vehículo remolque y/o del remolcado directamente mediante el enchufe.
- (IT) Non caricare la batteria del veicolo trainante o di quello trainato direttamente dalla presa.
- (SE) Ladda inte batteriet i det bogserande fordonet och/eller det bogserade fordonet direkt via kontakten.
- (CZ) Nenabíjete baterii tažného ani taženého vozidla přes zásuvku.
- (DK) Oplad ikke bugseringskøretøjet og/eller det bugserede køretøjs batteri direkte v.h.a. stikdåsen.
- (FI) Älä lataa hinaavan ajoneuvon ja/tai hinattavan ajoneuvon akkua suoraan pistorasian kautta.
- (GR) Μη φορτίζετε την μπαταρία του ρυμουλκούμενου οχήματος και/ή ρυμουλκημένου οχήματος απευθείας μέσω του ρευματοδότη.
- (NO) Batteriet til kjøretøyet som trekker eller blir trukket skal ikke lades direkte via koblingsboksen.
- (PL) Nie ładować akumulatora pojazdu holującego/holowanego bezpośrednio przez gniazdo.

- (DE) Gebrauchsanleitung
(FR) Mode d'emploi
(NL) Gebruikershandleiding
(GB) User guide
(ES) Guía del usuario
(IT) Manuale di istruzioni
(SE) Bruksanvisning
(CZ) Uživatelská příručka
(DK) Brugervejledning
(FI) Käyttöohjeet
(GR) Οδηγός χρήστη
(NO) Brukerveiledning
(PL) Instrukcja obsługi

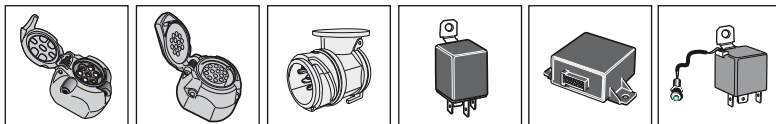
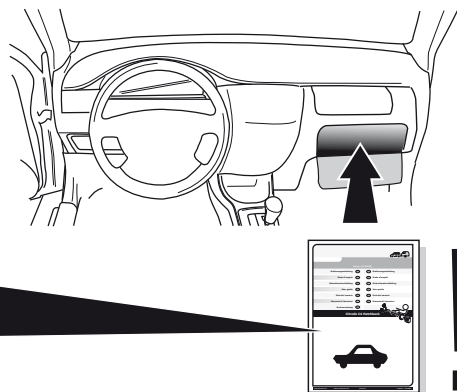

SPARE PARTS

www.ecs-electronics.com

ECS

ELECTRONICS



Partnr.: IV-005-DL

Gebrauchsanleitung (DE)

(CZ) Uživatelská příručka

Mode d'emploi (FR)

(DK) Brugervejledning

Gebruikershandleiding (NL)

(FI) Käyttöohjeet

User guide (GB)

(GR) Οδηγός χρήστη

Guía del usuario (ES)

(NO) Brukerveiledning

Manuale di istruzioni (IT)

(PL) Instrukcja obsługi

Bruksanvisning (SE)

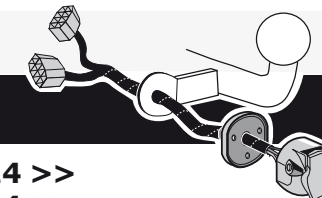

Iveco Daily chassis

07/2014 >>

Iveco Daily van

07/2014 >>

Iveco eDaily Chassis Cab & Pick up

07/2023 >>

Iveco eDaily Van

07/2023 >>

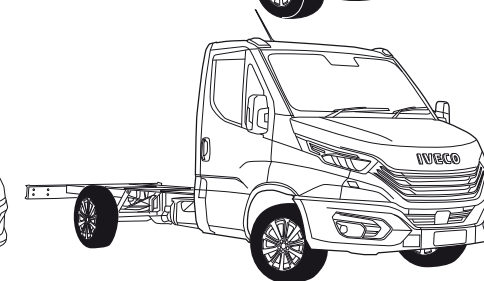
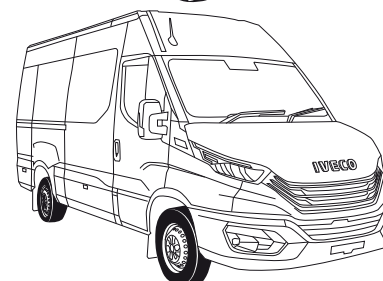
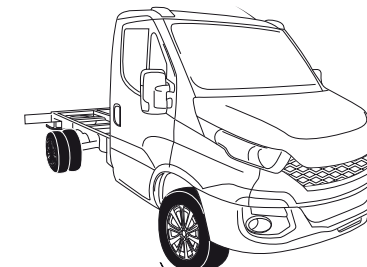
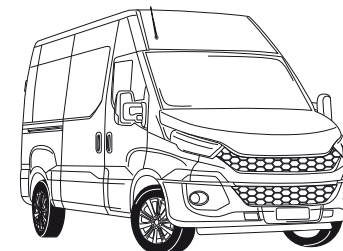

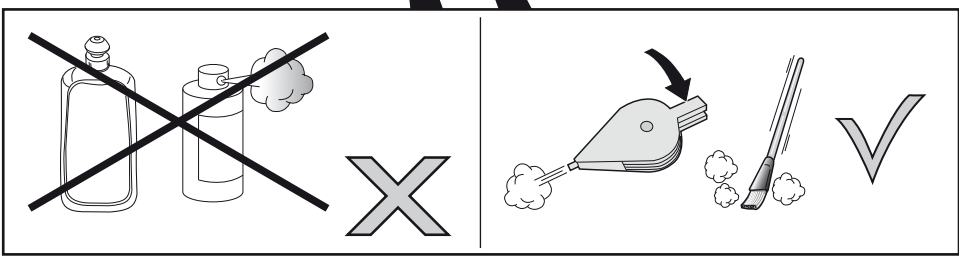
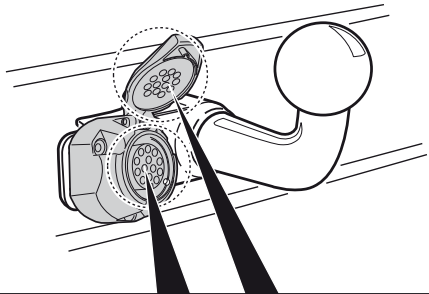
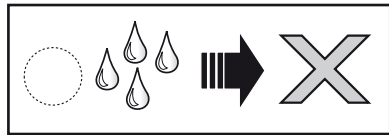
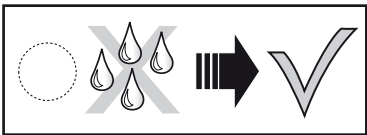
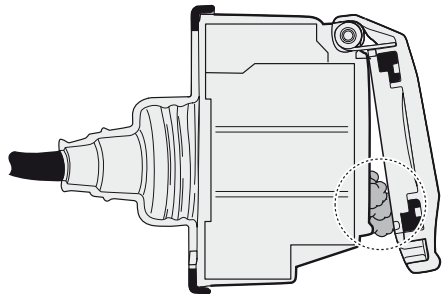
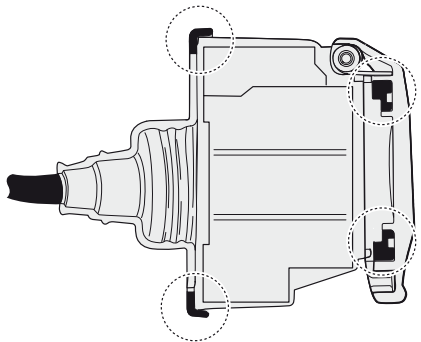
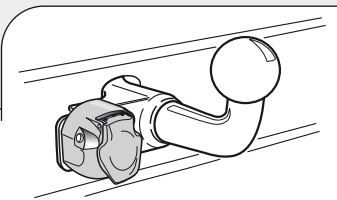
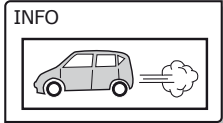

No fog light cut-off!

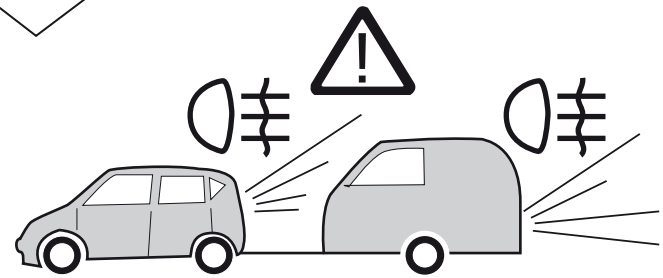
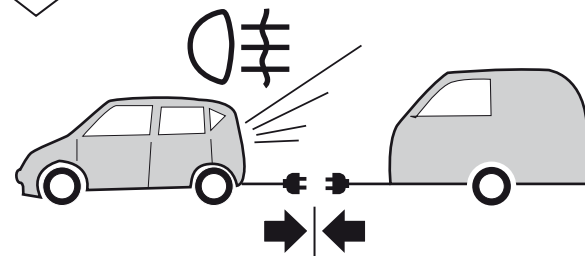
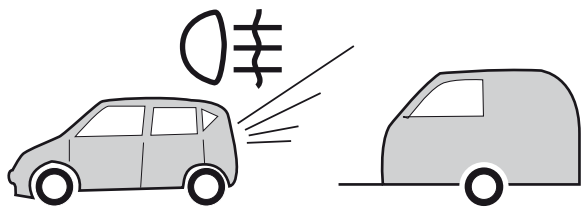
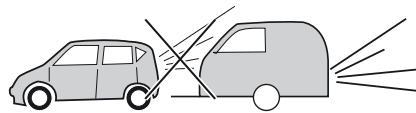

- (DE) Anschluss Steckdose
- (ES) Conexión de la caja de enchufe
- (CZ) Objímkový konektor
- (GR) Υποδοχή σπινθήρας
- (FR) Connection de la prise
- (IT) Allaccio zoccolo
- (DK) Stikkåbse forbindelse
- (NO) Tilkobling koblingsboks
- (NL) Contactdoos aansluiting
- (SE) Anslutning kontaktdosa
- (FI) Pistorasia liitäntä
- (PL) Połączenie przez gniazdo
- (GB) Socket connection

DIN/ISO 11446	↔	⚡	1-8	↕	☀️	⊙	☀️	⚡	☀️	⚡	⚡	⚡	⚡	⚡	⚡	⚡	⚡
Pmax	21W	2x21W	21W	52W	52W	3x21W	52W	2x21W	52W	7/58-L	52W	8	9	10	11	12	13
(DE)	Gelb	Blaü	Weiß	Grün	Braun	Rot (1,00mm²)	Schwarz	Schwarz/ Rot	Schwarz/ Rot								
(FR)	Jaune	Bleu	Blanc	Vert	Marron	Rouge (1,00mm²)	Noir	Ner/ Rouge	Ner/ Rouge								
(NL)	Gel	Blauw	Wit	Green	Bruin	Rood (1,00mm²)	Zwart	Zwart/ Rood	Zwart/ Rood								
(GB)	Yellow	Blue	White	Green	Brown	Red (1,00mm²)	Black	Black/ Red	Black/ Red								
(ES)	Amarillo	Azul	Blanco	Verde	Marrón	Rojo (1,00mm²)	Negro	Negro/ Rojo	Negro/ Rojo								
(IT)	Giallo	Blu	Bianco	Verde	Marrone	Rosso (1,00mm²)	Nero	Nero/ Rosso	Nero/ Rosso								
(SE)	Gul	Blå	Vit	Grön	Brun	Röd (1,00mm²)	Svart	Svart/ Röd	Svart/ Röd								
(CZ)	Žlutá	Modrá	Bílá	Zelená	Hnědá	Červená (1,00mm²)	Černá	Černo/ Červená	Černo/ Červená								
(DK)	Gul	Blå	Hvid	Grøn	Brun	Rød (1,00mm²)	Sort	Sort/ Rød	Sort/ Rød								
(FI)	Keltainen	Sininen	Valkoinen	Vihreä	Ruskea	Punainen (1,00mm²)	Musta	Musta/ Punainen	Musta/ Punainen								
(GR)	Κίτρινο	Μπλε	Λευκό	Πράσινο	Κοκκί	Κόκκινο (1,00mm²)	Μαύρο	Μαύρο/ Κόκκινο	Μαύρο/ Κόκκινο								
(NO)	Gul	Blå	Hvit	Grønn	Brun	Rød (1,00mm²)	Svart	Svart/ Rød	Svart/ Rød								
(PL)	Żółty	Niebieski	Biały	Zielony	Brazowy	Czerwony (1,00mm²)	Czarny	Czarny/ Czerwony	Czarny/ Czerwony								

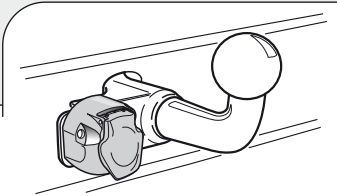
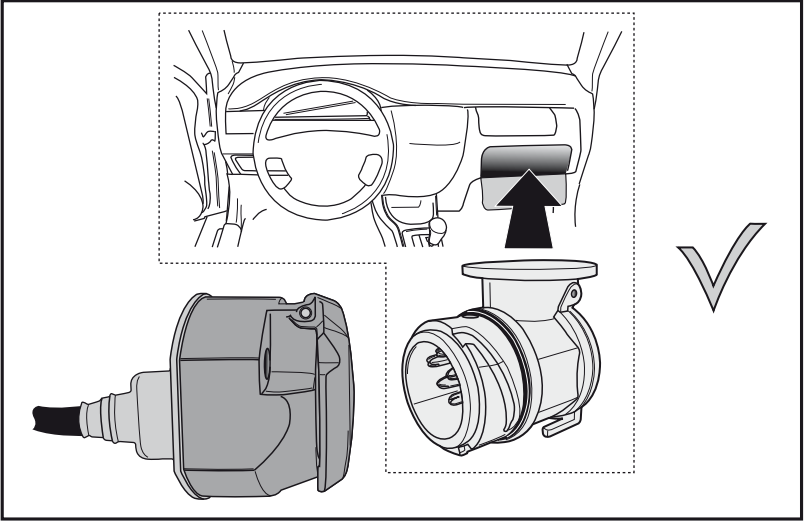
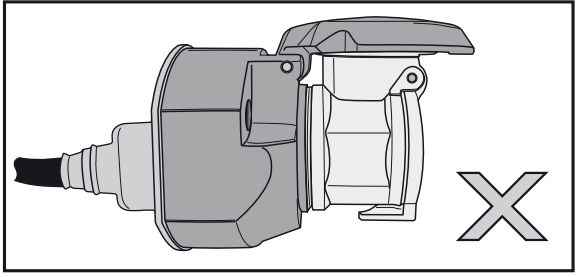
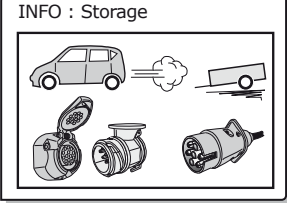

INFO : Ring.

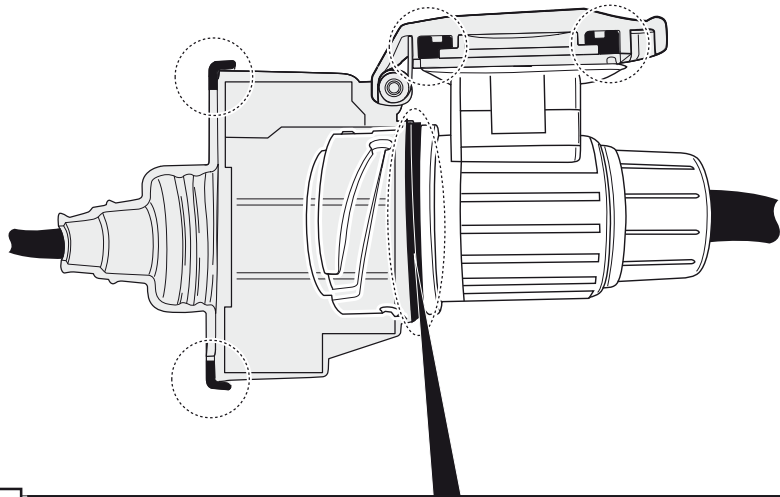
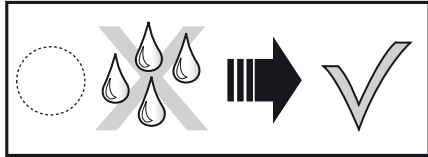
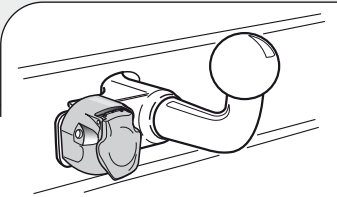
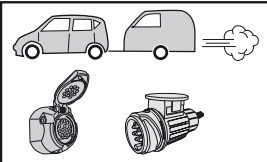

INFO

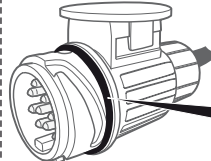
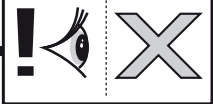
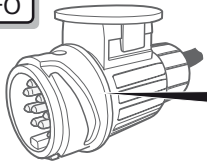

INFO : Adapt.

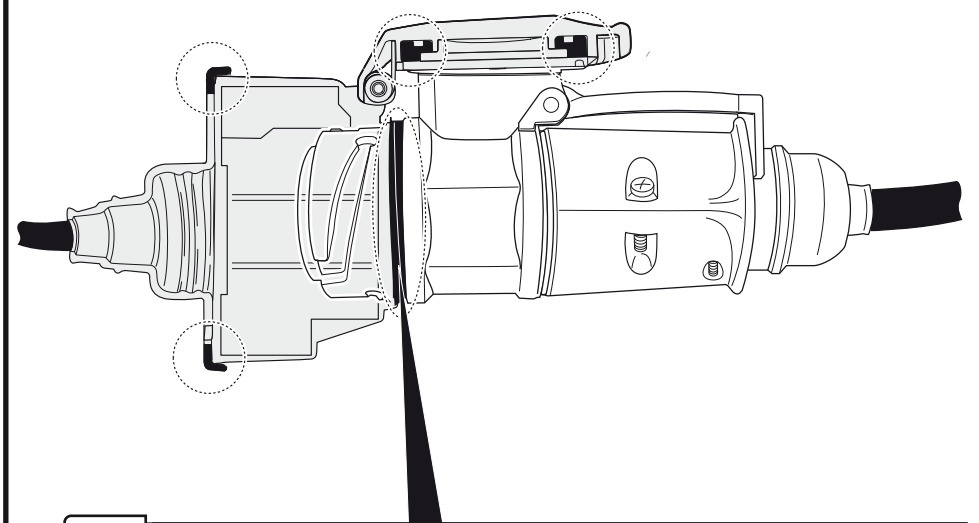
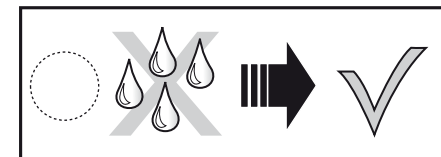
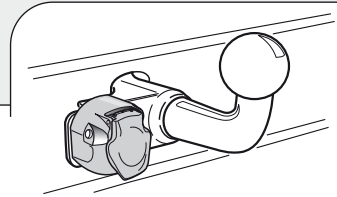
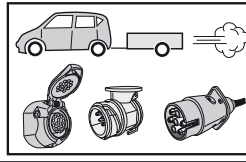

INFO

