

Fiat Croma Comfortwagon 06-2005-

Partnr.: FI-017-DB

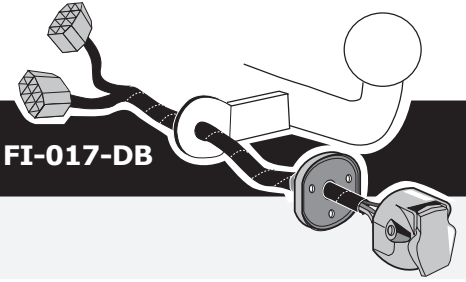

DE Einbauanleitung Elektrosatz Anhängervorrichtung mit 13-P Steckdose lt. DIN/ISO Norm 11446

FR Instructions de montage du faisceau électrique pour crochet d'attelage conforme à la norme DIN/ISO 11446 prise 13-V.

NL Montage-handleiding elektrokabelset voor trekhaak met 13-P contactdoos vlg. DIN/ISO norm 11446.

GB Fitting instructions electric wiring kit tow bar with 13-P socket up to DIN/ISO Norm 11446.

ES Instrucciones de montaje de kit eléctrico para engancho de remolque con caja de conexiones 13-P según norma DIN/ISO 11446.

IT Istruzioni di montaggio di set di cavi elettrici per gancio da traino con zoccolo a 13-P conforme alla norma DIN/ISO 11446.

SE Monteringsanvisningar elkabelsats för dragkrok med 13-P kontaktdosa enligt DIN/ISO norm 11446.

CZ Montážní pokyny: souprava pro elektrické propojení tažné tyče s 13-P zásuvkou do normy DIN/ISO 11446.

DK Monteringsvejledninger for det elektriske ledningsføringssæt for trækstang med 13-N stikdåse, DIN/ISO, norm 11446.

FI Ohjeet vetokoukun sähkökaapelisarjan asentamiseen, jossa on DIN/ISO 11446 mukainen 13-N liitin.

GR Οδηγίες συναρμολόγησης ηλεκτρικού σετ καλωδίων μπάρας ρυμούλκησης με υποδοχή 13-P μέχρι DIN/ISO Κανόνας 11446.

NO Monteringsanviser elkabelsett for trekrok med 13-P koblingsboks ifølge DIN/ISO norm 11446.

PL Instrukcje montażu zestawu okablowania elektrycznego dyszla holowniczego z 13-stykowym gniazdem DIN/ISO 11446.

DE - Wir weisen ausdrücklich darauf hin, dass eine unsachgemäße und nicht in einer Fachwerkstatt durchgeführte Montage einen Verzicht auf Entschädigung jeglicher Art insbesondere bezüglich des Produkthaftpflichtrechts zur Folge hat.

FR - Il est expressément prévu qu' on ne saurait se prévaloir d'un quelconque préjudice contractuel ou rédhibitoire si le montage avait été fait en dépit des dites instructions ou dans un garage ne disposant pas des équipements adéquats.

NL - Wij wijzen er met nadruk op, dat ondeskundige en niet door een vakkundige werkplaats uitgevoerde montage tot gevolg heeft dat daardoor ieder recht op schadevergoeding, ook op wettelijke aansprakelijkheid inzake producten, vervalt.

GB - We would expressly point out that any improper assembly which is not carried out in a specialist workshop will result in the renunciation of the enforcement of compensation claims of any kind, in particular those arising by virtue of the product liability law.

ES - El montaje inapropiado y efectuado por personal no cualificado originará la pérdida de todo derecho a indemnización o la expiración de toda responsabilidad civil con respecto al producto.

IT - Sottolineiamo espressamente che un montaggio inadeguato ed eseguito da un'officina non specializzata ha come conseguenza il decadere di qualsiasi diritto al risarcimento danni, nonché alla responsabilità legale relativa ai prodotti.

SE - Vi påpekar med eftertryck att all rätt till skadeersättning och all laglig ansvarighet förfaller om monteringen inte har utförts på rätt sätt och av en professionell verkstad.

CZ - Výslovně zdůrazňujeme, že jakákoli montáž, která není provedená ve specializované dílně, má za následek odvolání nároků na kompenzaci jakéhokoliv druhu, obzvláště vyplývajících ze zákona o odpovědnosti za způsobené škody.

DK - Vi ønsker at gøre udtrykkeligt opmærksom på at forkert samling, der ikke er udført af et specialiseret værksted, resulterer i bortfaldelse af kompenseringskrav af alle slags, i særdeles krav der måtte opstå omkring det lovpligtige ansvar.

FI - Korostamme, että kaikki oikeudet vahinkokorvaukseen kuten myös valmistajan laillinen vastuu raukeavat, mikäli asennusta ei ole toteutettu oikealla tavalla eikä ammattitaitoisen asiantuntijan toimesta.

GR - Επισημαίνουμε κατηγορηματικά ότι οποιαδήποτε εσφαλμένη συναρμολόγηση, η οποία δεν έχει πραγματοποιηθεί ειδικό εργαστήριο θα οδηγήσει σε απονοίση των αξιώσεων επιβολής αποζημιώσεων οποιαδήποτε είδους, ειδικά όσα προκύπτουν από το νόμο ευθύνης προϊόντων.

NO - Vi påpeker ettertrykkelig at all rett til skadeerstatning og rettslig ansvar forfaller dersom monteringen ikke er blitt utført på riktig måte og av et profesjonelt verksted.

PL - Chciłbyśmy wyraźnie zaznaczyć, iż wszelki nieprawidłowy montaż, który nie jest wykonywany w specjalistycznym warsztacie pociąga za sobą utratę możliwości dochodzenia wszelkiego typu roszczeń, w szczególności tych wynikających z odpowiedzialności producenta za swój produkt.

- Technische Änderungen vorbehalten.

- Widerstand nur gemäß der Tabelle auf dem Anhänger verwenden, siehe Seite 14.

- Sous réserve de modifications techniques.

- Ne excédez pas la charge maximale, indiquée dans le tableau sur page 14.

- Technische wijzigingen voorbehouden.

- Gebruik alleen belasting volgens aansluittabel op het getrokken voertuig, zie pagina 14.

- Subject to alteration without notice.

- Only use maximum charge according to connectiontable on towed vehicle, see page 14.

- Nos reservamos el derecho a efectuar modificaciones técnicas.

- Utilice sólo cargas de acuerdo a la tabla de conexión del vehículo remolcado (ver página 14).

- Ci si riserva il diritto di apportare modifiche tecniche.

- Utilizzare esclusivamente un carico conforme alla tabella degli allacci relativa al veicolo in questione, cfr. pagina 14.

- Tekniska ändringar förbehålles.

- Använd endast belastning enligt anslutningstabellen på det dragna fordonet, se sid. 14.

- Změny mohou být provedeny bez oznámení.

- Používejte pouze při maximálním nabití podle tabulky na tažném vozidle, viz. str. 14.

- Kan ændres uden varsel.

- Brug kun den maksimale belastning, i overensstemmelse med forbindelsestabelen for bugserede køretøjer, side 14.

- Oikeus teknisiin muutoksiin ilman erillistä huomautusta pidätetään.

- Kuormita työvirtapiiriä ainoastaan hinattavan ajoneuvon kytkentäkaavion mukaisesti, katso sivu 14.

- Μπορεί να τροποποιηθεί χωρίς προηγούμενη ειδοποίηση.

- Χρησιμοποιείτε μόνο μέγιστο ηλεκτρικό φορτίο σύμφωνα με τον πίνακα σύνδεσης στο ρυμούλκούμενο όχημα, δείτε σελίδα 14.

- Tekniske endringer forbeholdes. - Overskrid ikke grensene anvist i tilkoblingstabellen på tilhengeren eller det tilkoblede kjøretøyet, se s. 14.

- Podlega zmianom bez powiadomienia.

- Używać tylko takiego maksymalnego obciążenia które wynika z tabliczki połączeń holowanego pojazdu, patrz strona 14.

Einzelteilliste

Liste de pieces

Onderdelenlijst

Part list

Lista de componentes

Elenco componenti

Dellista

Seznam dílů

Del-liste

Osaluettelo

Κατάλογος εξαρτημάτων

Delliste

Lista części

DE

FR

NL

GB

ES

IT

SE

CZ

DK

FI

GR

NO

PL

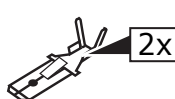
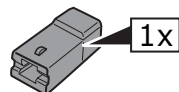
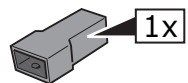
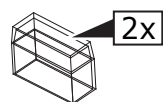
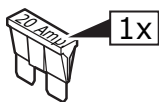
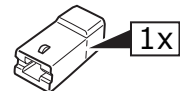
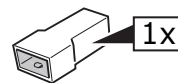
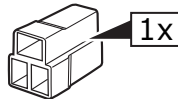
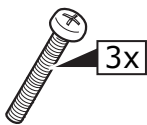
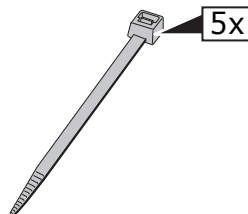
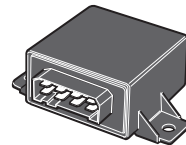
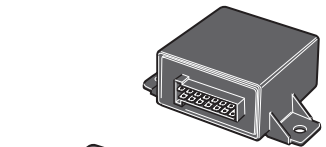
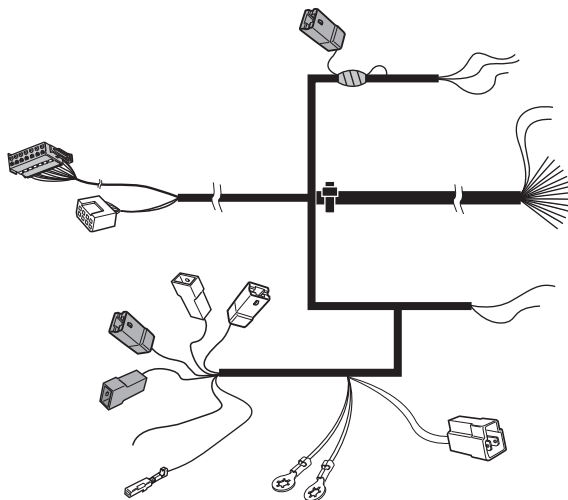
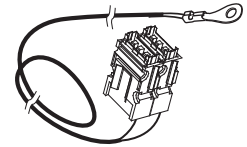
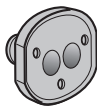
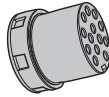
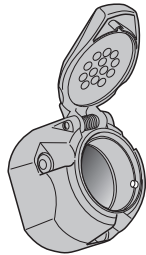
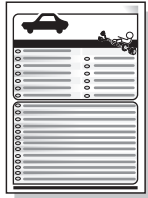
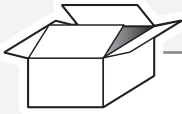

1

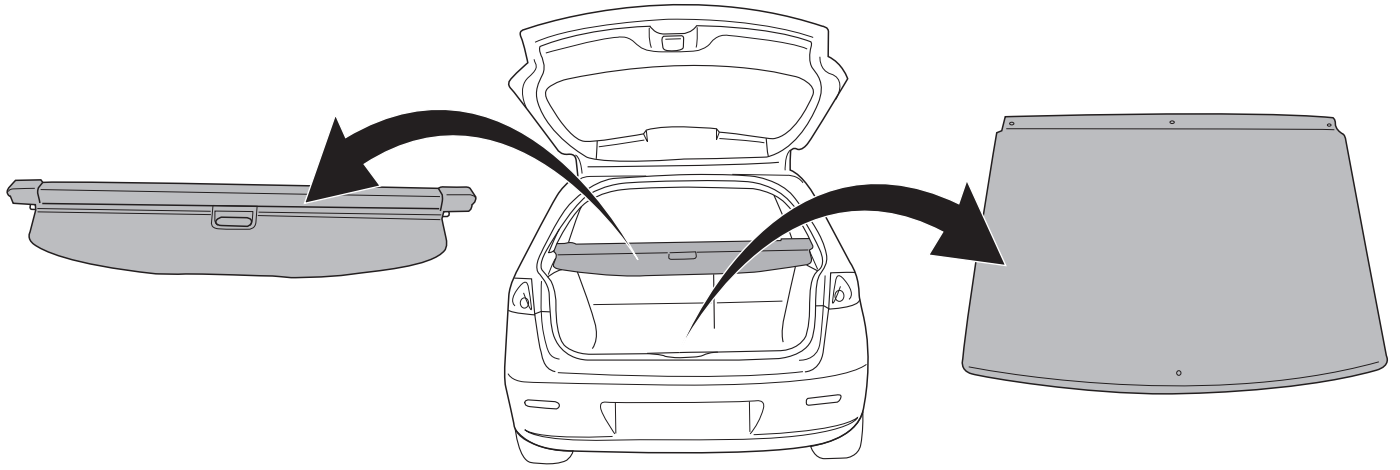

2

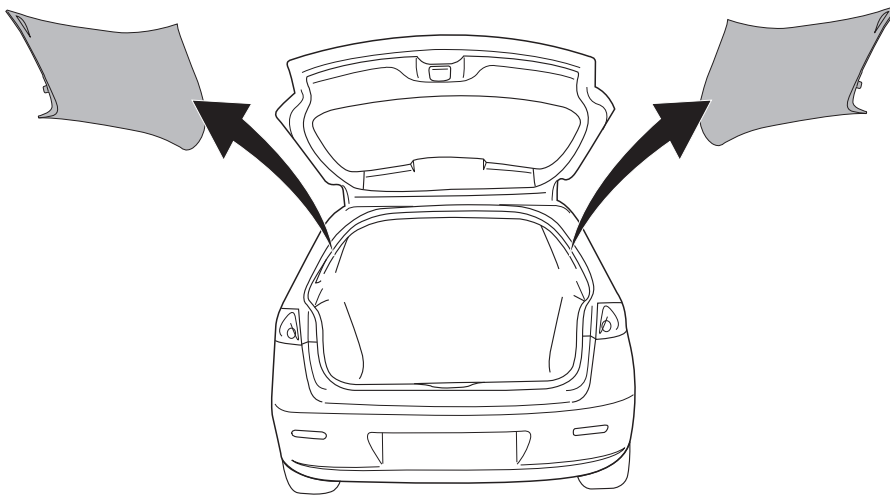

3

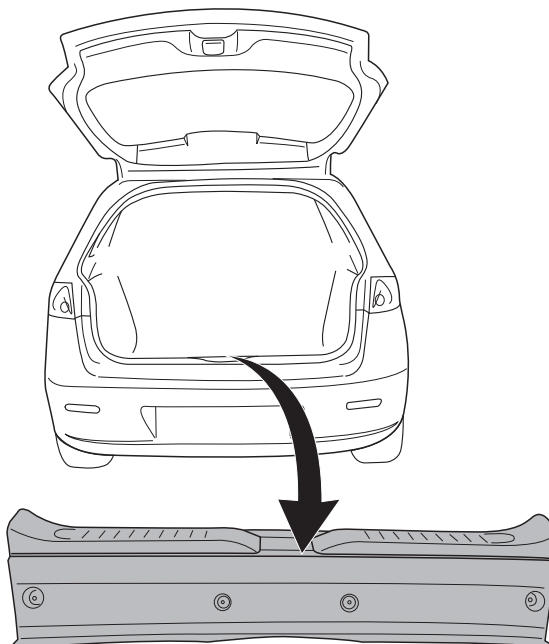

INFO

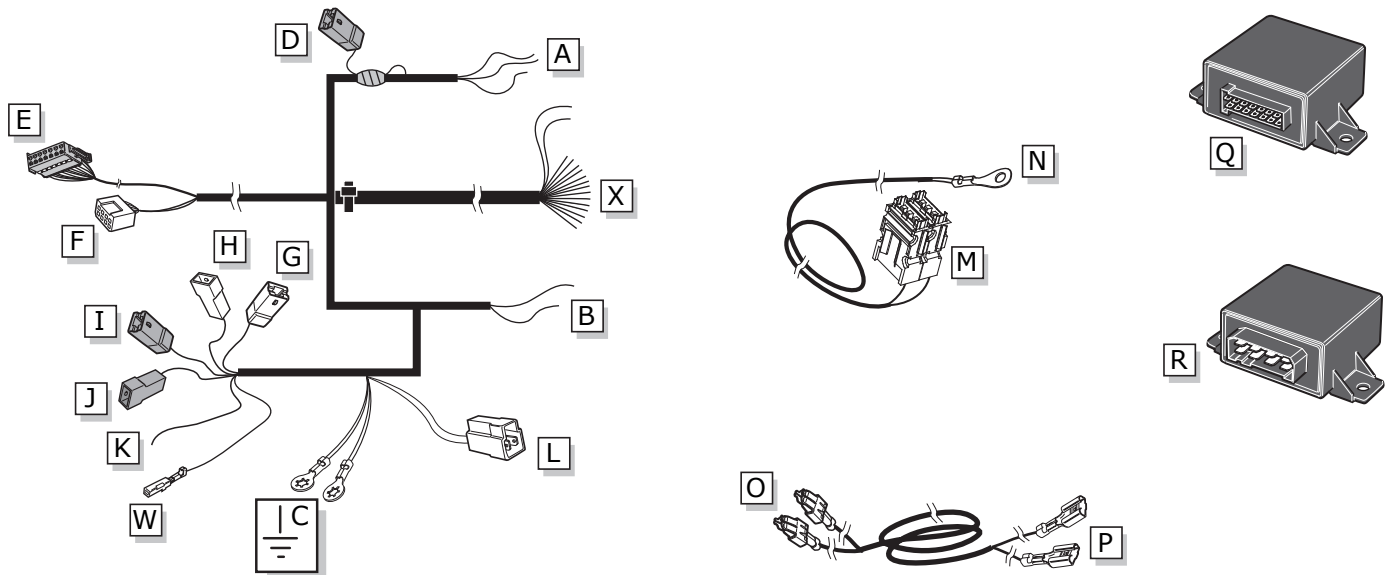

ROUTING

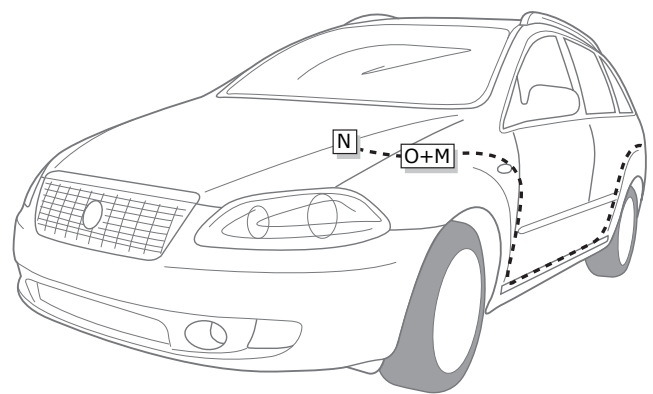
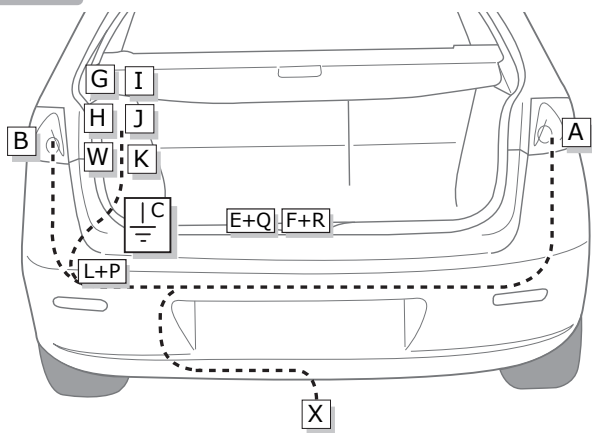

4

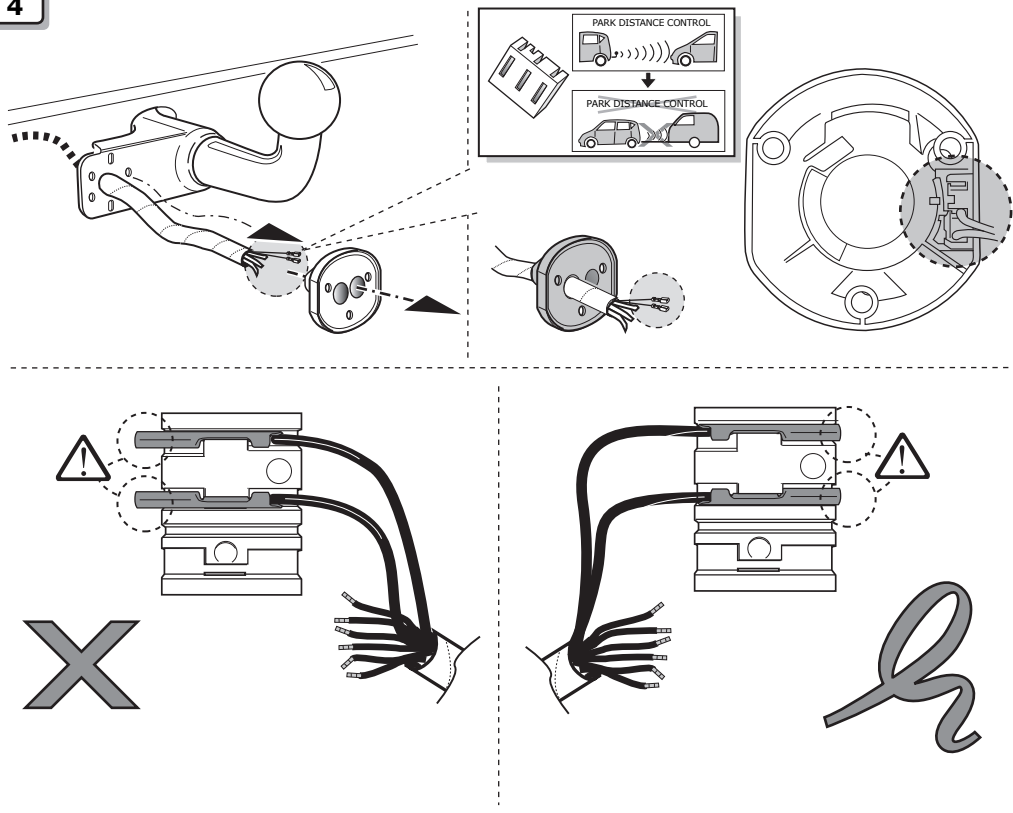

INFO

- (DE) Anschluss Steckdose
- (FR) Connection de la prise
- (NL) Contactdoos aansluiting
- (GB) Socket connection
- (ES) Conexión de la caja de enchufe
- (IT) Allaccio zoccolo
- (SE) Anslutning kontaktdosa
- (CZ) Objímkový konektor
- (DK) Stikdåse forbindelse
- (FI) Pistorasia liitäntä
- (GR) Υποδοχή σύνδεσης
- (NO) Tilkobling koblingsboks
- (PL) Połączenie przez gniazdo



Pag. 14

5

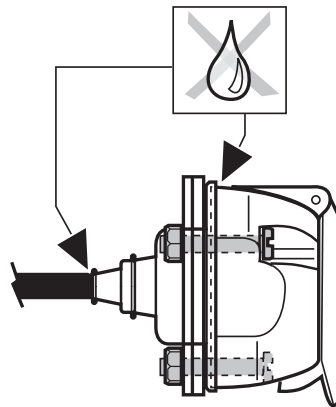
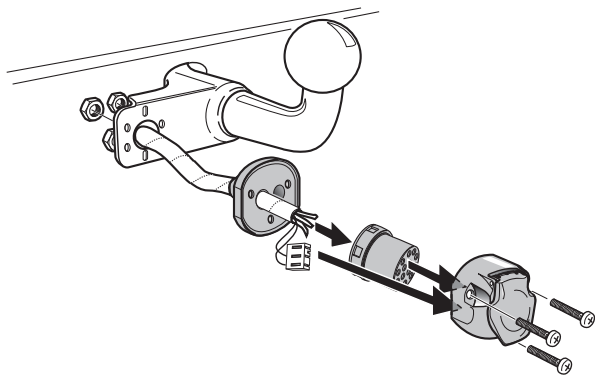

6

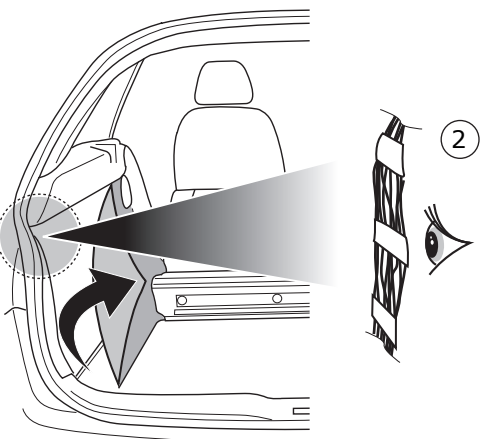
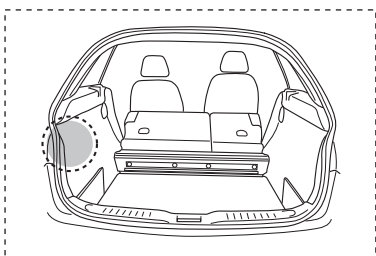
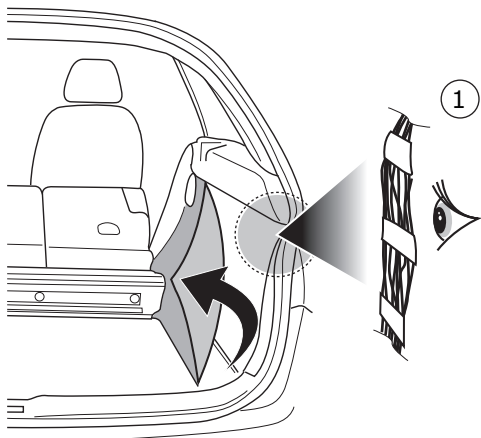
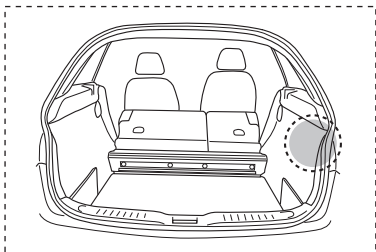

	DE Farben FR Couleurs NL Kleuren GB Colours ES Colores IT Colori SE Färgar	CZ Barevným DK Farverne FI Coloria GR χρώματα NO Farget PL Kolorowac
	1 54 STOP
1 58R ☀️	
1 R ➡️	
2 58L ☀️	
2 L ➡️	
3 Reverse 🚗	
3 L ⚡️	
3 R ⚡️	

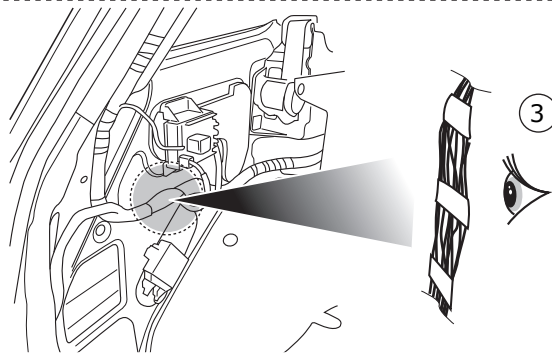
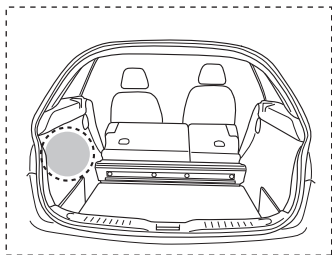

7

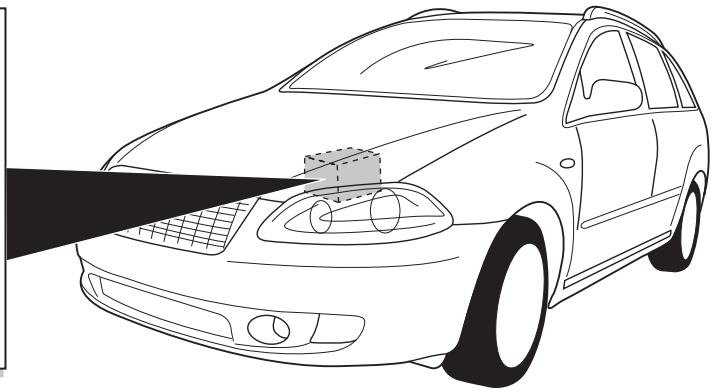
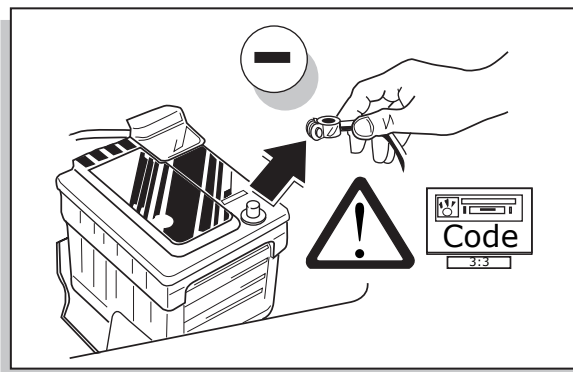

8

	Farben Couleurs Kleuren Colours Colores Colori Fárgar	Barevnými Farverne Coloria χρώματα Farget Kolorować
① 54		
① 58R		
① R		
② 58L		
② L		
③		
③ L		
③ R		

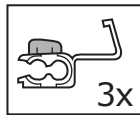

A

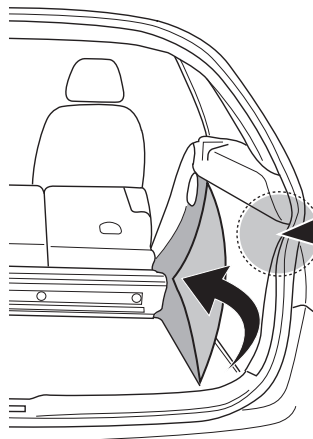

54 STOP

1

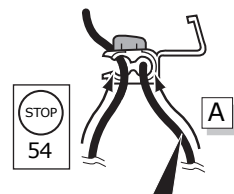

2



DE Blau/Rot	CZ Modrá/Červená
FR Blue/Rouge	DK Blå/Rød
NL Blauw/Rood	FI Sininen/Punainen
GB Blue/Red	GR Μπλε/Κόκκινο
ES Azul/Rojo	NO Blå/Rød
IT Blu/Rosso	PL Niebieski/Czerwony
SE Blå/Röd	

R →

1

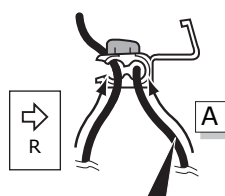

2



DE Schwarz/Grün	CZ Černá/Zelená
FR Noir/Vert	DK Sort/Grøn
NL Zwart/Groen	FI Musta/Vihreä
GB Black/Green	GR Μαύρο/Πράσινο
ES Negro/Verde	NO Svart/Grønn
IT Nero/Verde	PL Czarny/Zielony
SE Svart/Grön	

58R ☀

1

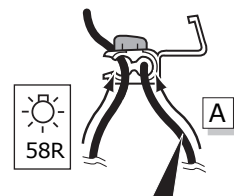

2



DE Schwarz/Braun	CZ Černá/Hnědá
FR Noir/Marron	DK Sort/Brun
NL Zwart/Bruin	FI Musta/Ruskea
GB Black/Brown	GR Μαύρο/Καφέ
ES Negro/Marrón	NO Svart/Brun
IT Nero/Marrone	PL Czarny/Brazowy
SE Svart/Brun	

	● Farben ● Couleurs ● Kleuren ● Colours ● Colores ● Colori ● Färgar	● Barevným ● Farverne ● Coloria ● χρώματα ● Färget ● Kolorować
① 54		
① 5BR		
① R		
② 58L		
② L		
③		
③ L		
③ R		

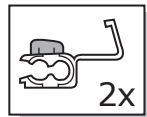

B

58L

1

2

DE Violett/Schwarz	CZ Fialová/Černá
FR Violet/Noir	DK Lilla/Sort
NL Paars/Zwart	FI Purppura/Musta
GB Purple/Black	GR Μαύο/Μαύο
ES Morado/Negro	NO Lilla/Svart
IT Viola/Nero	PL Purpurowy/Czarny
SE Lila/Svart	

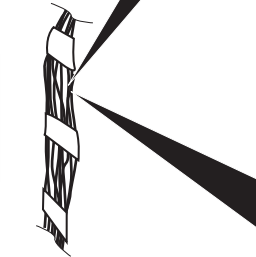
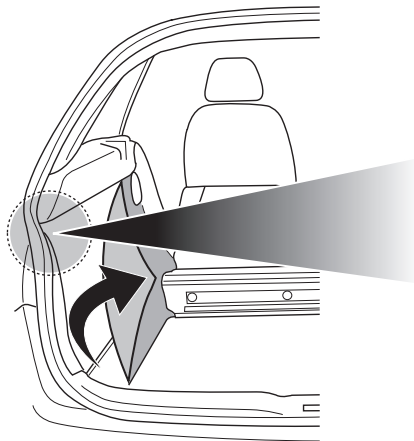

L

1

2

DE Schwarz/Gelb	CZ Černá/Žlutá
FR Noir/Jaune	DK Sort/Gul
NL Zwart/Geel	FI Musta/Keltainen
GB Black/Yellow	GR Μαύο/Κίτρινο
ES Negro/Amarillo	NO Svart/Gul
IT Nero/Giallo	PL Czarny/Żółty
SE Svart/Gul	

	● Farben ● Couleurs ● Kleuren ● Colours ● Colores ● Colori ● Färgar	● Barevným ● Farverne ● Coloria ● χρώματα ● Färget ● Kolorować
① 54		
① 5BR		
① R		
② 58L		
② L		
③		
③ L		
③ R		

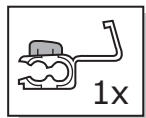

K

Reverse

1

2

DE Grün/Rot	CZ Zelená/Červená
FR Vert/Rouge	DK Grøn/Rød
NL Groen/Rood	FI Vihreä/Punainen
GB Green/Red	GR Πράσινο/Κόκκινο
ES Verde/Rojo	NO Grønn/Rød
IT Verde/Rosso	PL Zielony/Czerwony
SE Grön/Röd	

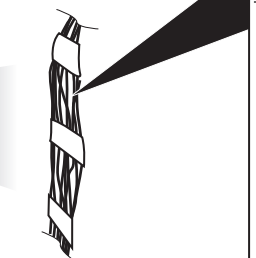
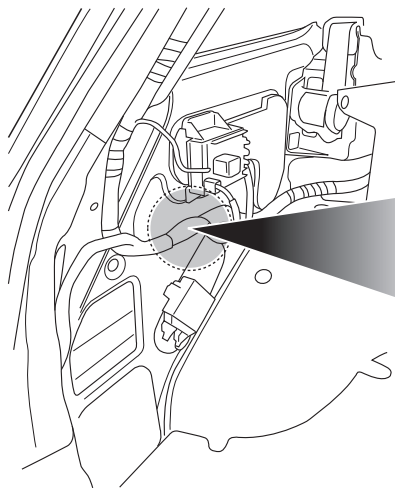

	● Farben	● Barevným
	● Couleurs	● Farverne
	● Kleuren	● Coloria
	● Colours	● χρώματα
	● Colores	● Farget
	● Colori	● Kolorować
	● Färgar	

① 54	
① 5BR	
① R	
② 5BL	
② L	
③	
③ L	
③ R	

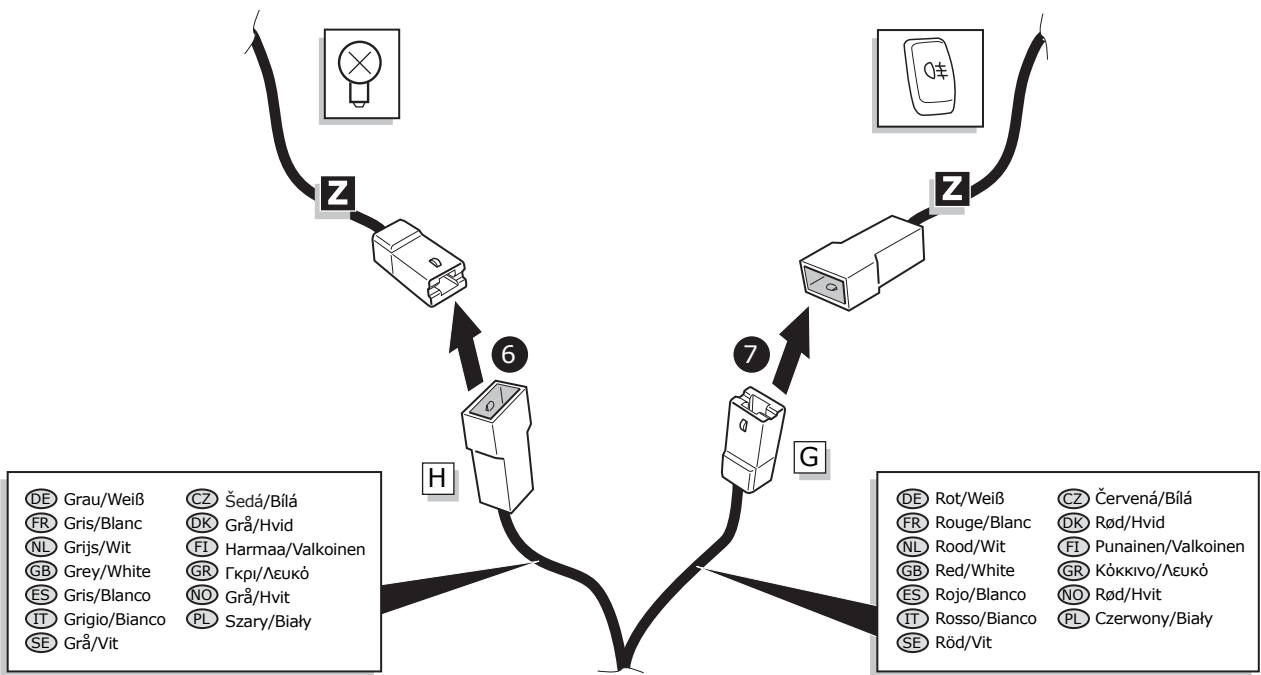
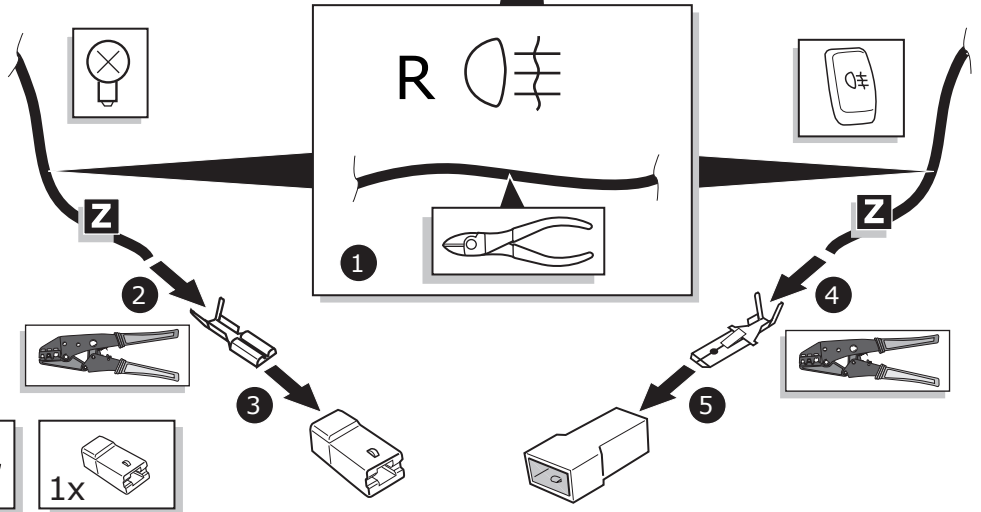
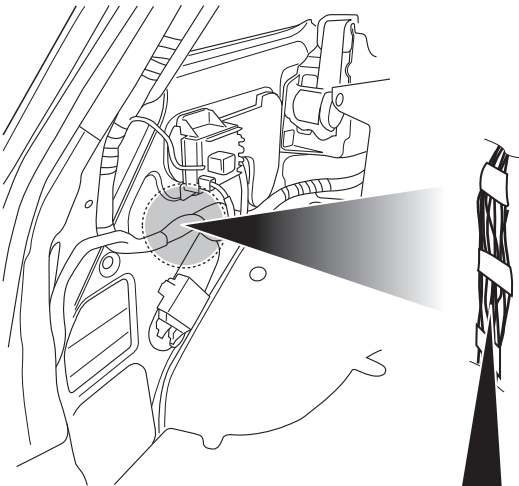

	Färben	Barevným
	Couleurs	Farverne
	Kleuren	Coloria
	Colours	χρώματα
	Colores	Färgar
	Colori	Färgar
	Kolorować	Kolorować
	Färgar	Färgar

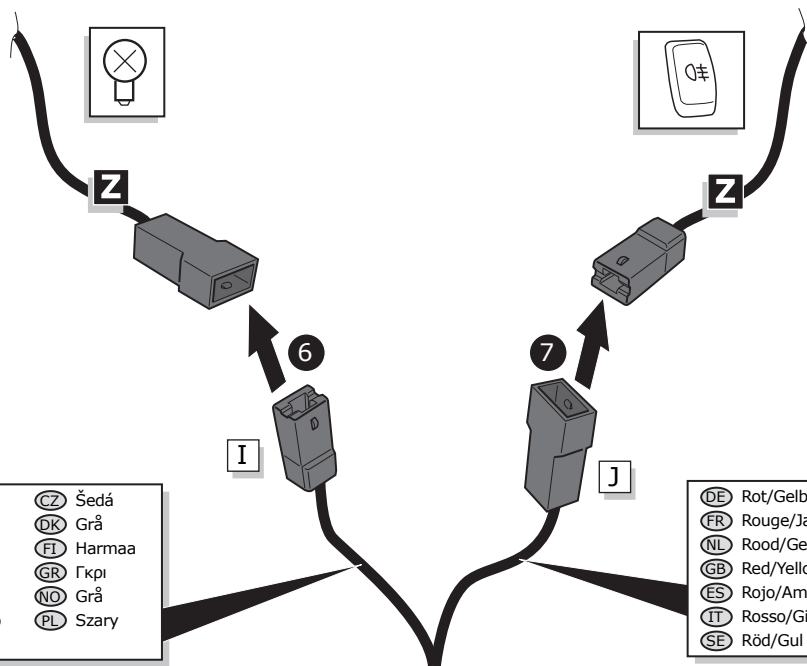
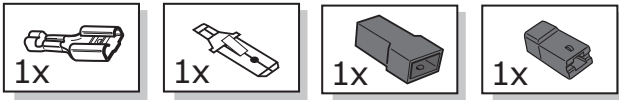
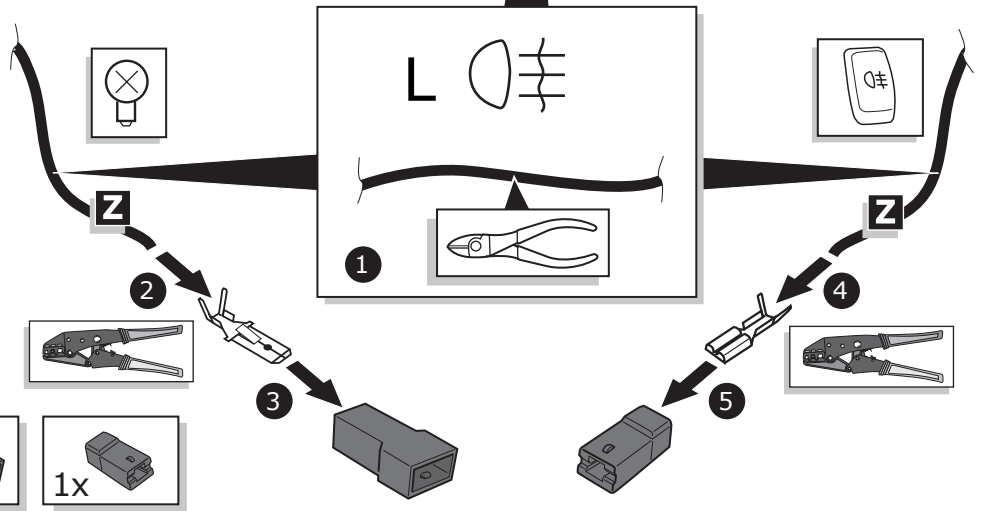
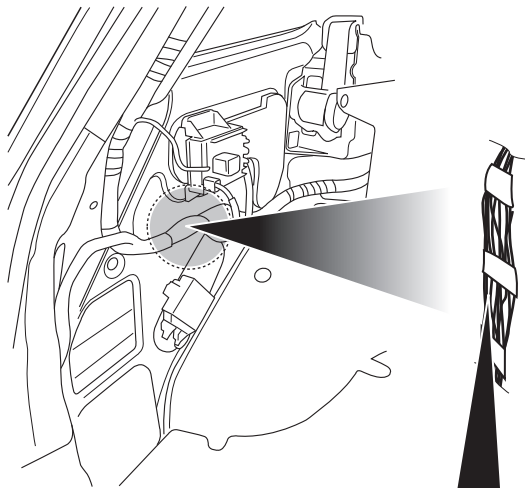

DE	Grau	CZ	Šedá
FR	Gris	DK	Grå
NL	Grijs	FI	Harmaa
GB	Grey	GR	Γκρι
ES	Gris	NO	Grå
IT	Grigio	PL	Szary
SE	Grå		

DE	Rot/Gelb	CZ	Červená/Žlutá
FR	Rouge/Jaune	DK	Rød/Gul
NL	Rood/Geel	FI	Punainen/Keltainen
GB	Red/Yellow	GR	Κόκκινο/Κίτρινο
ES	Rojo/Amarillo	NO	Rød/Gul
IT	Rosso/Giallo	PL	Czerwony/Żółty
SE	Röd/Gul		

13

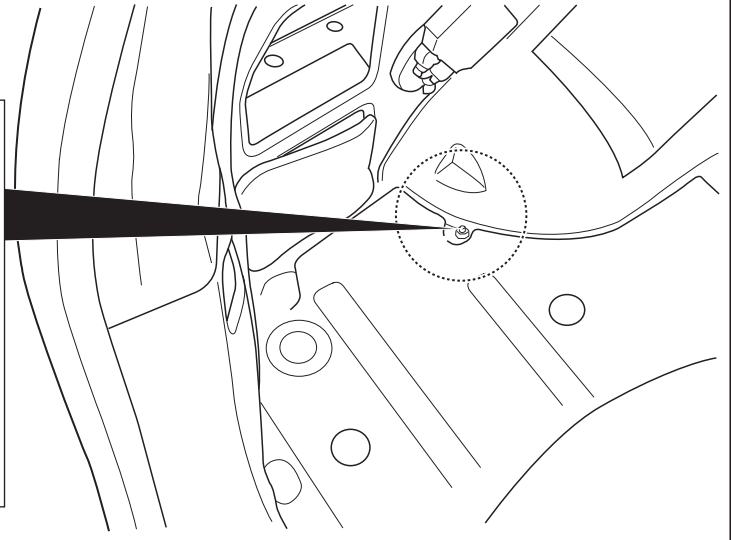
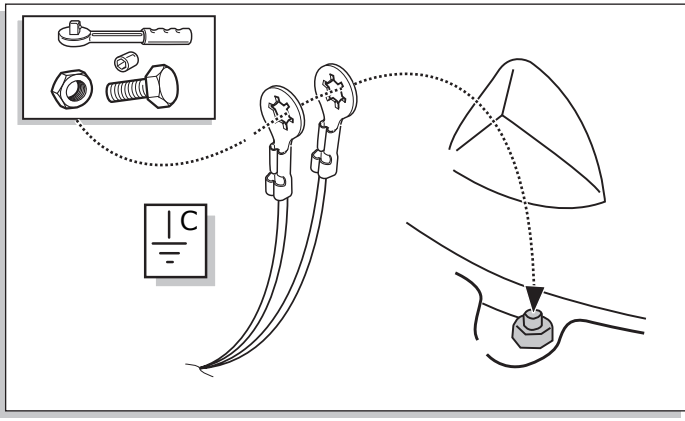

14

OPTION 1

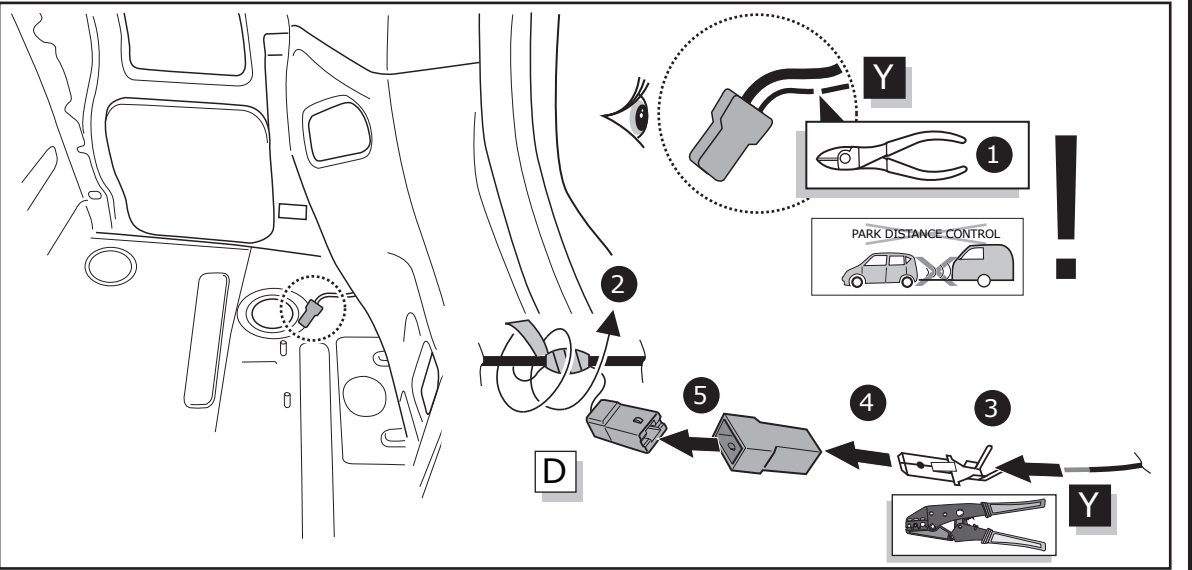
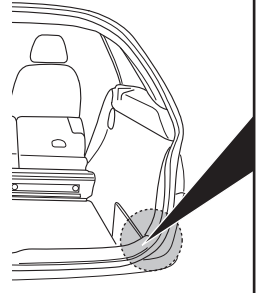
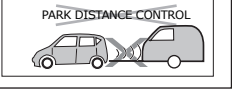

15

OPTION 2

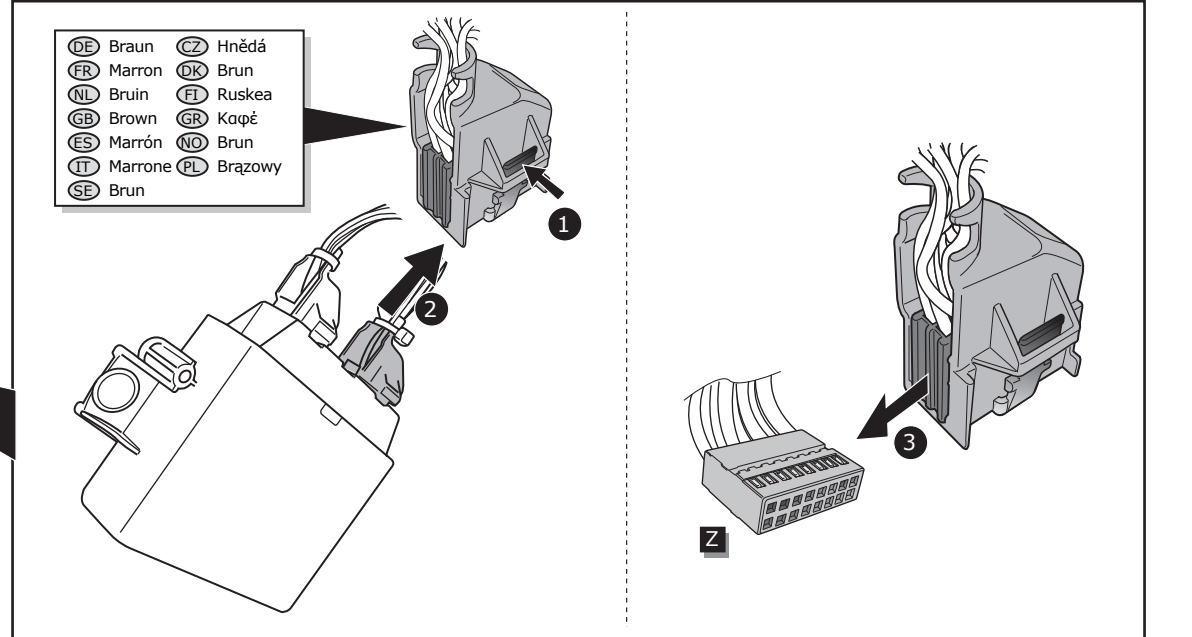
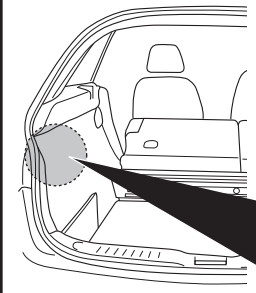
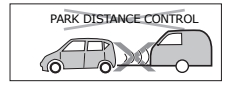

16

OPTION 2

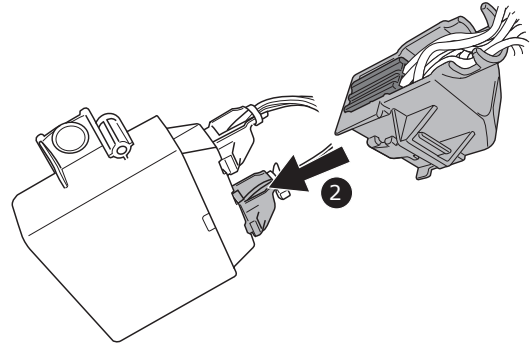
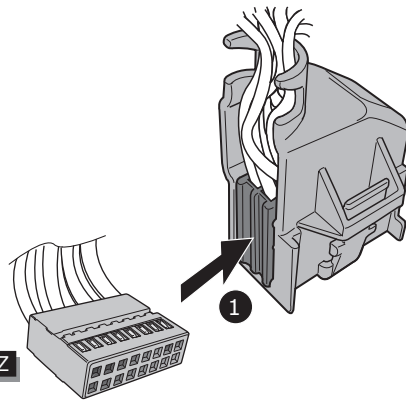
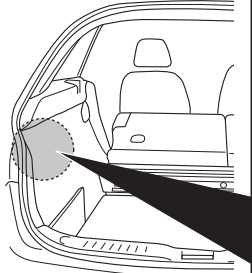
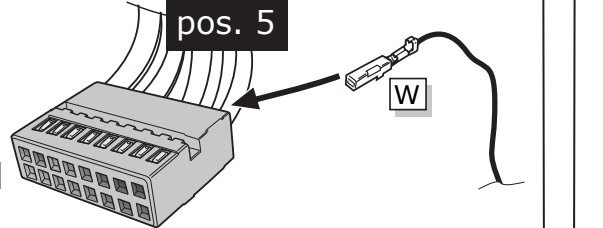
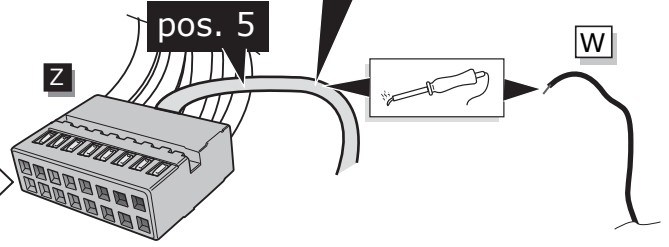
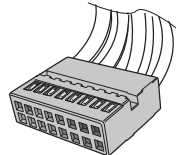
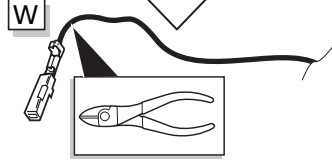
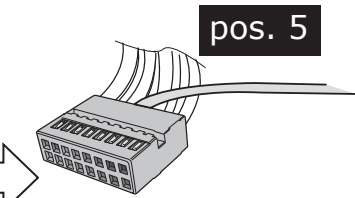
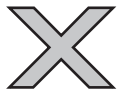
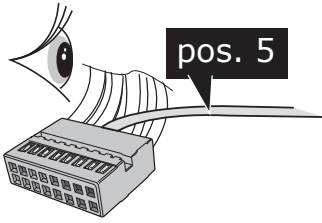

17

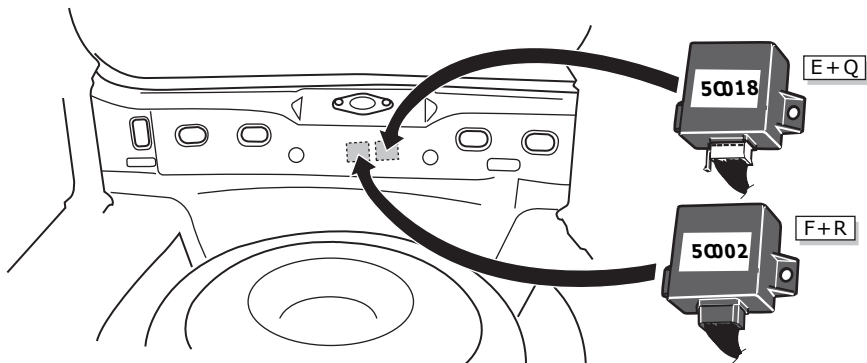
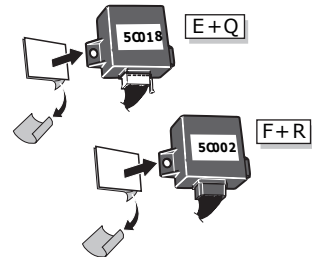
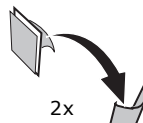
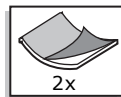
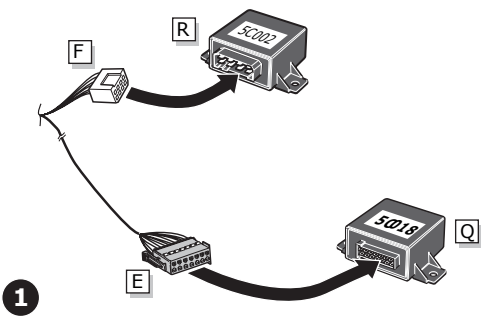

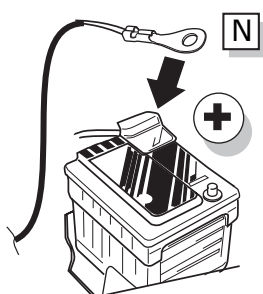
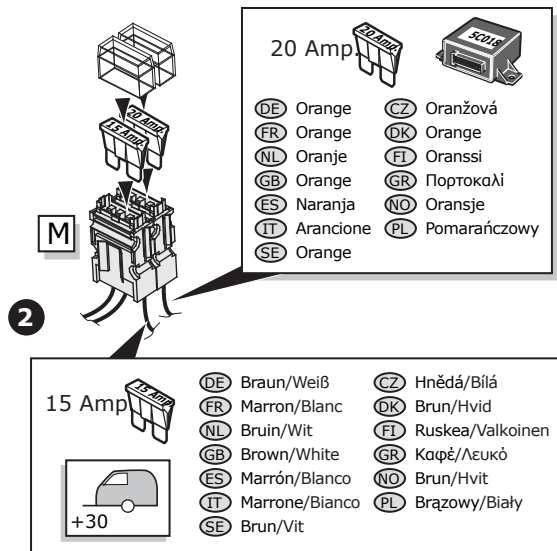
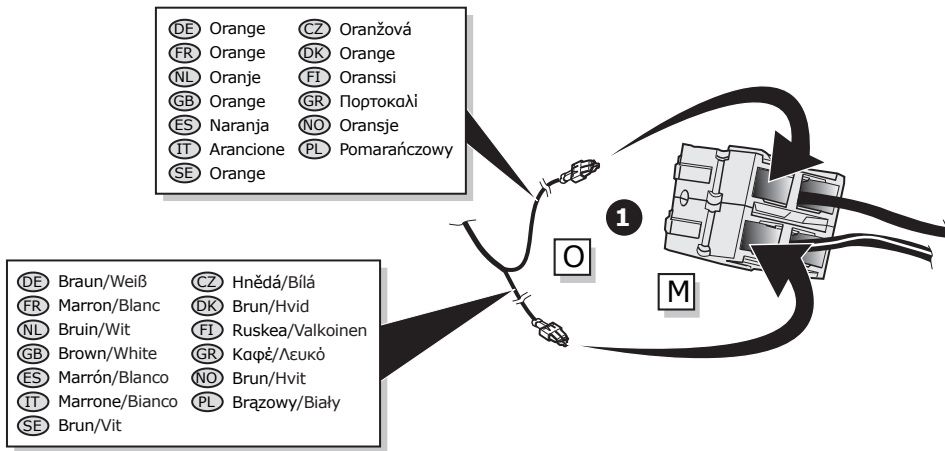
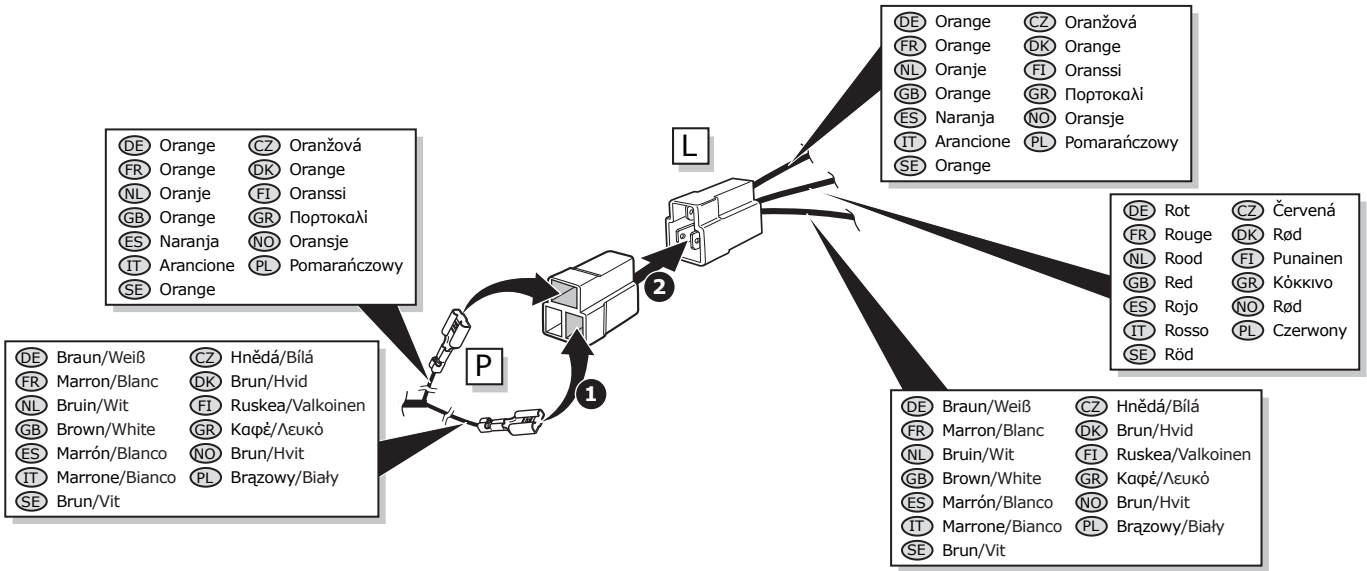

19

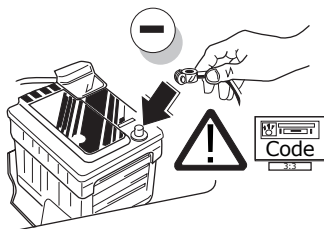

20

- DE** FUNKTIONEN KONTROLLIEREN MIT EINEM PRÜFGERÄT MIT WIDERSTAND ODER MIT LEUCHTEN MIT DER GENAUEN WATTZAHL!
- FR** CONTRÔLER LES FONCTIONS AVEC UNE BOÎTE DE TEST AVEC DE LA CHARGE OU DES LAMPES AVEC LA QUANTITÉ CORRECTE DE WATT!
- NL** CONTROLEER FUNCTIES MET EEN TESTER MET BELASTING OF LAMPEN MET DE JUISTE WATTAGE!
- GB** CHECK FUNCTIONS WITH A TESTBOX WITH LOAD OR LAMPS WITH THE RIGHT AMOUNT OF WATT!
- ES** ¡CONTROLAR FUNCIONES CON UN TESTER CON CARGA O LUCES CON EL CORRECTO WATTAJE!
- IT** CONTROLLA FUNZIONI CON UN TESTER CON CARICO O LAMPADE DEL GIUSTO WATT-TAGGIO!
- SE** KONTROLLERA FUNKTIONERNA MED EN TESTARE MED BELASTNING ELLER LAMPOR MED RÄTT WATT-VÄRDE!
- CZ** OVĚŘTE FUNKCE POMOCÍ TESTOVACÍHO BOXU NEBO SVĚTEL S PŘÍSLUŠNÝM VÝKONEM!
- DK** CHECK FUNKTIONERNE MED EN TESTBOKS, MED BELASTNING ELLER MED LYGTER MED DET KORREKTE ANTAL WATT!
- FI** TARKISTA TOIMINNOT KÄYTTÄMÄLLÄ TESTILAITE, JOSSA ON OIKEATEHOINEN KUORMITUS TAI OIKEATEHOISET LAMPUT!
- GR** ΕΛΕΓΕΤΕ ΤΙΣ ΛΕΙΤΟΥΡΓΙΕΣ ΜΕ ΉΝΑ ΚΙΒΩΤΙΟ ΔΟΚΙΜΗΣ ΜΕ ΦΟΡΤΙΟ Ή ΛΑΜΠΙΤΗΡΕΣ ΣΩΣΤΗΣ ΠΟΣΟΤΗΤΑΣ ΒΑΤ!
- NO** KONTROLER FUNKSJONENE MED EN TESTER MED BELASTNING ELLER LYSPÆRER MED RIKTIG WATTVERDI!
- PL** SPRAWDŹ FUNKCJE UŻYWAJĄC SKRZYŃKI TESTOWEJ Z OBCIĄŻENIEM LUB PODŁĄCZONYMI ŻARÓWKAMI O ODPOWIEDNIEJ MOCY!

21

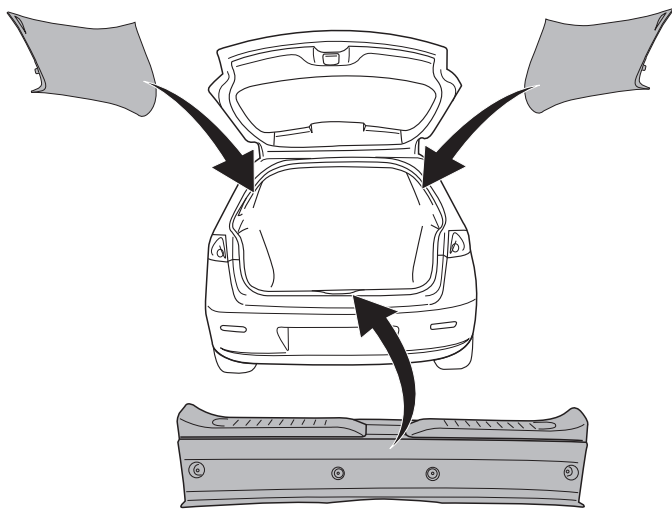

22

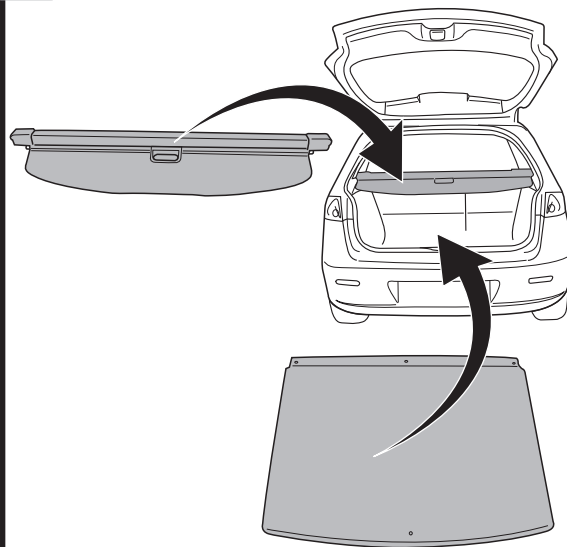

- (DE) Anschluss Steckdose (ES) Conexión de la caja de enchufe (CZ) Objímkový konektor (GR) Υποδοχή σύνδεσης
 (FR) Connection de la prise (IT) Allaccio zoccolo (DK) Stikdåse forbindelse (NO) Tilkobling koblingsboks
 (NL) Contactdoos aansluiting (SE) Anslutning kontaktdosa (FI) Pistorasia liitäntä (PL) Połączenie przez gniazdo
 (GB) Socket connection

DIN/ISO 11446												Option	Option
1/L	2	2a		1-8	4/R	5/58-R	6/54	7/58-L	8	9	10	10	11
Pmax	21W	2x21W	21W	21W	3x21W	52W	3x21W	52W	2x21W	180W/15Amp.	180W/15Amp.	180W/15Amp.	12
(DE)	Gelb	Blau	Grün	Weiß	Rot (1,00mm ²)	Braun	Rot (1,00mm ²)	Schwarz	Schwarz/ Rot	Braun/ Weiß	Rot (2,50mm ²)	Rot (2,50mm ²)	Weiß
(FR)	Jaune	Bleu	Vert	Blanc	Rouge (1,00mm ²)	Marron	Rouge (1,00mm ²)	Noir	Noir/ Rouge	Marron/ Blanc	Rouge (2,50mm ²)	Rouge (2,50mm ²)	Blanc
(NL)	Geel	Blauw	Groen	Wit	Rood (1,00mm ²)	Bruin	Rood (1,00mm ²)	Zwart	Zwart/ Rood	Bruin/ Wit	Rood (2,50mm ²)	Rood (2,50mm ²)	Wit
(GB)	Yellow	Blue	Green	White	Red (1,00mm ²)	Brown	Red (1,00mm ²)	Black	Black/ Red	Brown/ White	Red (2,50mm ²)	Red (2,50mm ²)	White
(ES)	Amarillo	Azul	Verde	Blanco	Rojo (1,00mm ²)	Marrón	Rojo (1,00mm ²)	Negro	Negro/ Rojo	Marrón/ Blanco	Rojo (2,50mm ²)	Rojo (2,50mm ²)	Blanco
(IT)	Giallo	Blu	Verde	Bianco	Rosso (1,00mm ²)	Marrone	Rosso (1,00mm ²)	Nero	Nero/ Rosso	Marrone/ Bianco	Rosso (2,50mm ²)	Rosso (2,50mm ²)	Bianco
(SE)	Gul	Blå	Grön	Vit	Röd (1,00mm ²)	Brun	Röd (1,00mm ²)	Svart	Svart/ Röd	Brun/ Vit	Röd (2,50mm ²)	Röd (2,50mm ²)	Vit
(CZ)	Žlutá	Modrá	Zelená	Bílá	Červená (1,00mm ²)	Hnědá	Červená (1,00mm ²)	Černá	Černá/ Červená	Hnědá/ Bílá	Červená (2,50mm ²)	Červená (2,50mm ²)	Bílá
(DK)	Gul	Blå	Grøn	Hvid	Rød (1,00mm ²)	Brun	Rød (1,00mm ²)	Sort	Sort/ Rød	Brun/ Hvid	Rød (2,50mm ²)	Rød (2,50mm ²)	Hvid
(FI)	Keltainen	Sininen	Vihreä	Valkoinen	Punainen (1,00mm ²)	Ruskea	Punainen (1,00mm ²)	Musta	Musta/ Punainen	Ruskea/ Valkoinen	Punainen (2,50mm ²)	Punainen (2,50mm ²)	Valkoinen
(GR)	Κίτρινο	Μπλε	Πράσινο	Λευκό	Κόκκινο (1,00mm ²)	Καφέ	Κόκκινο (1,00mm ²)	Μαύρο	Μαύρο/ Κόκκινο	Καφέ/ Λευκό	Κόκκινο (2,50mm ²)	Κόκκινο (2,50mm ²)	Λευκό
(NO)	Gul	Blå	Grønn	Hvit	Rød (1,00mm ²)	Brun	Rød (1,00mm ²)	Svart	Svart/ Rød	Brun/ Hvit	Rød (2,50mm ²)	Rød (2,50mm ²)	Hvit
(PL)	Żółty	Niebieski	Zielony	Biały	Czerwony (1,00mm ²)	Brązowy	Czerwony (1,00mm ²)	Czarny	Czarny/ Czerwony	Brązowy/ Biały	Czerwony (2,50mm ²)	Czerwony (2,50mm ²)	Biały