

Fiat Croma Comfortwagon 06-2005-

Partnr.: FI-017-BB

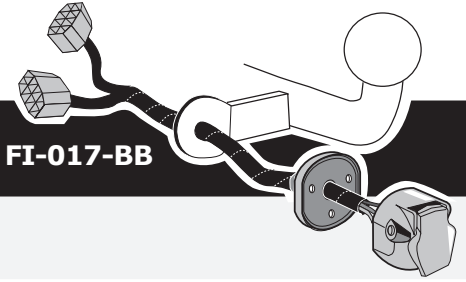

DE Einbauanleitung Elektrosatz Anhängervorrichtung mit 12-N Steckdose lt. DIN/ISO Norm 1724.

FR Instructions de montage du faisceau électrique pour crochet d'attelage conforme à la norme DIN/ISO 1724 prise 12-N

NL Montage-handleiding elektrokabelset voor trekhaak met 12-N contactdoos vlg. DIN/ISO norm 1724.

GB Fitting instructions electric wiring kit tow bar with 12-N socket up to DIN/ISO Norm 1724.

ES Instrucciones de montaje de kit eléctrico para enganche de remolque con caja de conexiones 12-N según norma DIN/ISO 1724.

IT Istruzioni di montaggio di set di cavi elettrici per gancio da traino con zoccolo a 12 N conforme alla norma DIN/ISO 1724.

SE Monteringsanvisningar elkabelsats för dragkrok med 12-N kontaktdosa enligt DIN/ISO norm 1724.

CZ Montážní pokyny: souprava pro elektrické propojení tažné tyče s 12 - N zásuvkou do normy DIN/ISO 1724.

DK Monteringsvejledninger for det elektriske ledningsføringssæt for trækstang med 12-N stikdåse, DIN/ISO, norm 1724.

FI Ohjeet vetokoukun sähkökaapelisarjan asentamiseen, jossa on DIN/ISO 1724 mukainen 12-N liitin.

GR Οδηγίες συναρμολόγησης ηλεκτρικού σετ καλωδίων μπάρας ρυμούλκησης με υποδοχή 12-N μέχρι DIN/ISO Κανόνας 1724.

NO Monteringsanviser elkabelsett for trekrok med 12-N koblingsboks ifølge DIN/ISO norm 1724.

PL Instrukcje montażu zestawu okablowania elektrycznego dyszla holowniczego z 12-N stykowym gniazdem DIN/ISO 1724.

DE - Wir weisen ausdrücklich darauf hin, dass eine unsachgemäße und nicht in einer Fachwerkstatt durchgeführte Montage einen Verzicht auf die Entschädigung jeglicher Art insbesondere bezüglich des Produkthaftpflichtrechts zur Folge hat.

FR - Il est expressément prévu qu' on ne saurait se prévaloir d'un quelconque préjudice contractuel ou rédhibitoire si le montage avait été fait en dépit des dites instructions ou dans un garage ne disposant pas des équipements adéquats.

NL - Wij wijzen er met nadruk op, dat ondeskundige en niet door een vakkundige werkplaats uitgevoerde montage tot gevolg heeft dat daardoor ieder recht op schadevergoeding, ook op wettelijke aansprakelijkheid inzake producten, vervalt.

GB - We would expressly point out that any improper assembly which is not carried out in a specialist workshop will result in the renunciation of the enforcement of compensation claims of any kind, in particular those arising by virtue of the product liability law.

ES - El montaje inapropiado y efectuado por personal no cualificado originará la pérdida de todo derecho a indemnización o la expiración de toda responsabilidad civil con respecto al producto.

IT - Sottolineiamo espressamente che un montaggio inadeguato ed eseguito da un'officina non specializzata ha come conseguenza il decadere di qualsiasi diritto al risarcimento danni, nonché alla responsabilità legale relativa ai prodotti.

SE - Vi påpekar med eftertryck att all rätt till skadeersättning och all laglig ansvarighet förfaller om monteringen inte har utförts på rätt sätt och av en professionell verkstad.

CZ - Výslovně zdůrazňujeme, že jakákoli montáž, která není provedená ve specializované dílně, má za následek odvolání nároků na kompenzaci jakéhokoli druhu, obzvláště vyplývajících ze zákona o odpovědnosti za způsobené škody.

DK - Vi ønsker at gøre udtrykkeligt opmærksom på at forkert samling, der ikke er udført af et specialiseret værksted, resulterer i bortfaldelse af kompenseringskrav af alle slags, i særdeles krav der måtte opstå omkring det lovpligtige ansvar.

FI - Korostamme, että kaikki oikeudet vahinkokorvaukseen kuten myös valmistajan laillinen vastuu raukeavat, mikäli asennusta ei ole toteutettu oikealla tavalla eikä ammattitaitoisen asiantuntijan toimesta.

GR - Επισημαίνουμε κατηγορηματικά ότι οποιαδήποτε εσφαλμένη συναρμολόγηση, η οποία δεν έχει πραγματοποιηθεί ειδικό εργαστήριο θα οδηγήσει σε απονοίηση των αξιώσεων επιβολής αποζημιώσεων οποιαδήποτε είδους, ειδικά όσα προκύπτουν από το νόμο ευθύνης προϊόντων.

NO - Vi påpeker ettertrykkelig at all rett til skadeerstatning og rettslig ansvar forfaller dersom monteringen ikke er blitt utført på riktig måte og av et profesjonelt verksted.

PL - Chcielibyśmy wyraźnie zaznaczyć, iż wszelki nieprawidłowy montaż, który nie jest wykonywany w specjalistycznym warsztacie pociąga za sobą utratę możliwości dochodzenia wszelkiego typu roszczeń, w szczególności tych wynikających z odpowiedzialności producenta za swój produkt.

- Technische Änderungen vorbehalten.

- Widerstand nur gemäß der Tabelle auf dem Anhänger verwenden, siehe Seite 13.

- Sous réserve de modifications techniques.

- Ne excédez pas la charge maximale, indiquée dans le tableau sur page 13.

- Technische wijzigingen voorbehouden.

- Gebruik alleen belasting volgens aansluittabel op het getrokken voertuig, zie pagina 13.

- Subject to alteration without notice.

- Only use maximum charge according to connectiontable on towed vehicle, see page 13.

- Nos reservamos el derecho a efectuar modificaciones técnicas.

- Utilice sólo cargas de acuerdo a la tabla de conexión del vehículo remolcado (ver página 13).

- Ci si riserva il diritto di apportare modifiche tecniche.

- Utilizzare esclusivamente un carico conforme alla tabella degli allacci relativa al veicolo in questione, cfr. pagina 13.

- Tekniska ändringar förbehålles.

- Använd endast belastning enligt anslutningstabellen på det dragna fordonet, se sid. 13.

- Změny mohou být provedeny bez oznámení.

- Používejte pouze při maximálním nabití podle tabulky na tažném vozidle, viz. str. 13.

- Kan ændres uden varsel.

- Brug kun den maksimale belastning, i overensstemmelse med forbindelsestabelen for bugserede køretøjer, side 13.

- Oikeus teknisiin muutoksiin ilman erillistä huomautusta pidätetään.

- Kuormita työvirtapiiriä ainoastaan hinattavan ajoneuvon kytkentäkaavion mukaisesti, katso sivu 13.

- Μπορεί να τροποποιηθεί χωρίς προηγούμενη ειδοποίηση.

- Χρησιμοποιείτε μόνο μέγιστο ηλεκτρικό φορτίο σύμφωνα με τον πίνακα σύνδεσης στο ρυμούλκούμενο όχημα, δείτε σελίδα 13.

- Tekniske endringer forbeholdes. - Overskrid ikke grensene anviset i tilkoblingstabellen på tilhengeren eller det tilkoblede kjøretøyet, se s. 13.

- Podlega zmianom bez powiadomienia.

- Używać tylko takiego maksymalnego obciążenia które wynika z tabliczki połączeń holowanego pojazdu, patrz strona 13.

Einzelteilliste

Liste de pieces

Onderdelenlijst

Part list

Lista de componentes

Elenco componenti

Dellista

Seznam dílů

Del-liste

Osaluettelo

Κατάλογος εξαρτημάτων

Delliste

Lista części

(DE)

(FR)

(NL)

(GB)

(ES)

(IT)

(SE)

(CZ)

(DK)

(FI)

(GR)

(NO)

(PL)

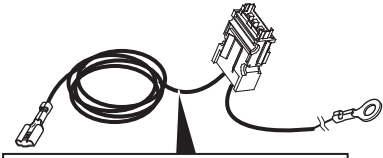
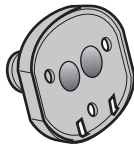
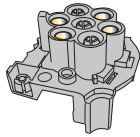
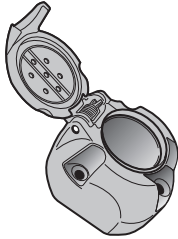
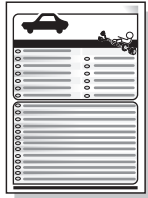
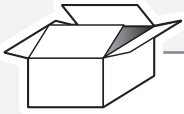

(DU)	Orange	(CZ)	Oranžová
(FR)	Orange	(DK)	Orange
(NL)	Oranje	(FI)	Oranssi
(GB)	Orange	(GR)	Πορτοκαλί
(ES)	Naranja	(NO)	Oransje
(IT)	Arancione	(PL)	Pomarańczowy
(SE)	Orange		

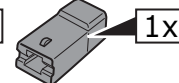
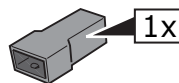
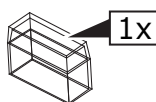
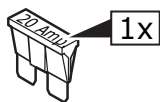
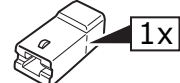
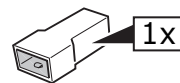
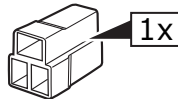
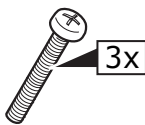
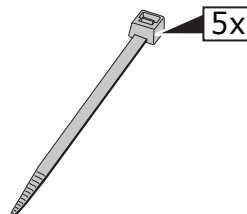
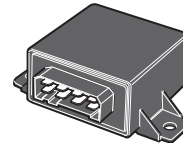
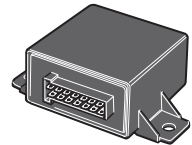
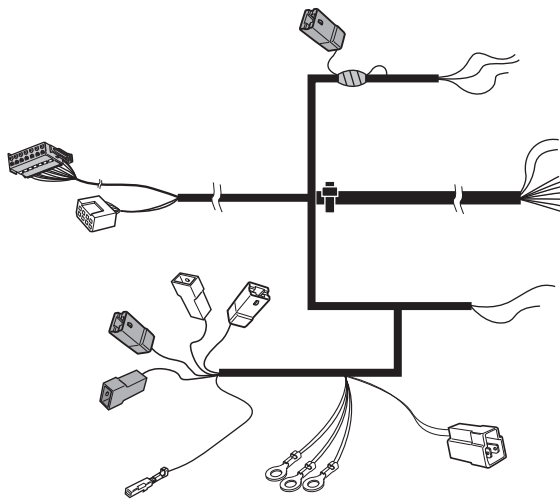

1

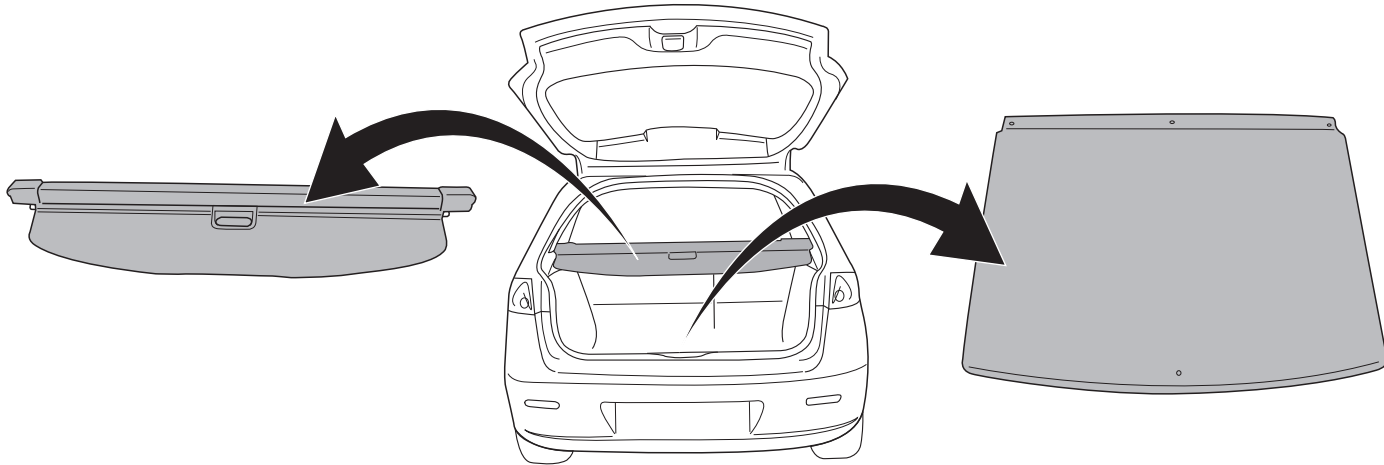

2

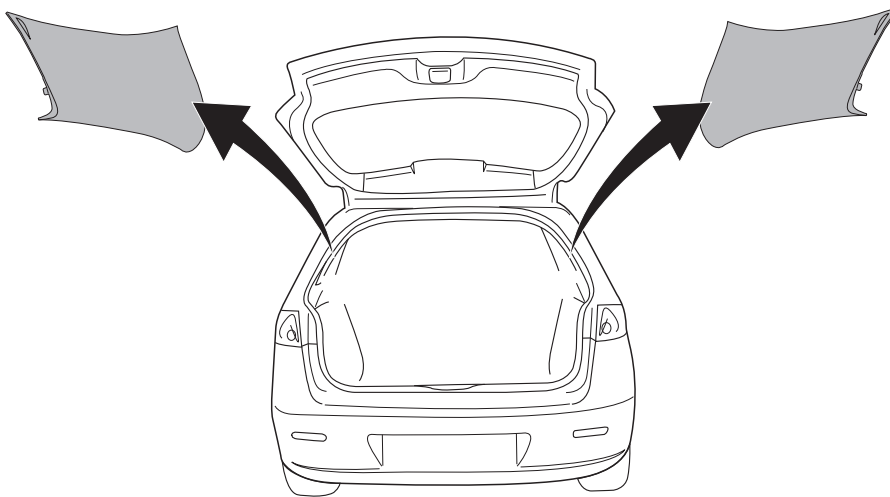

3

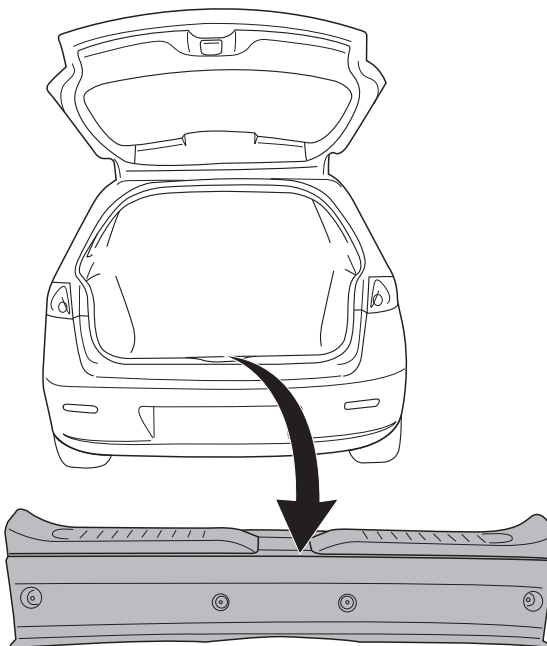

INFO

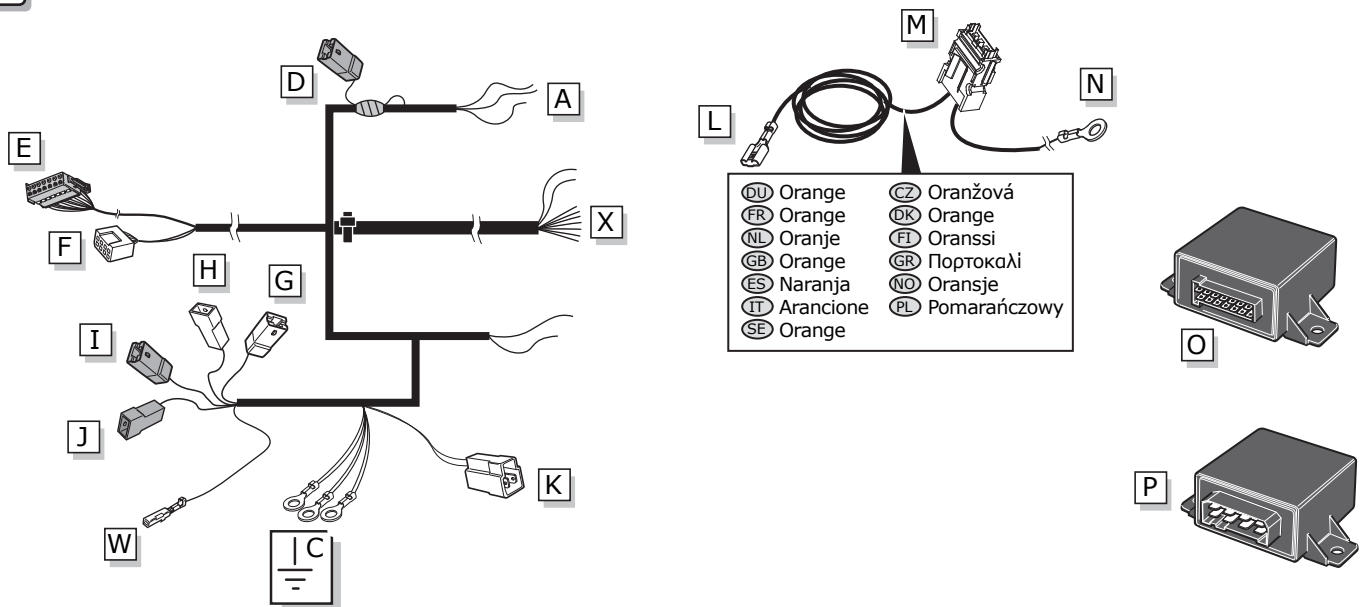

ROUTING

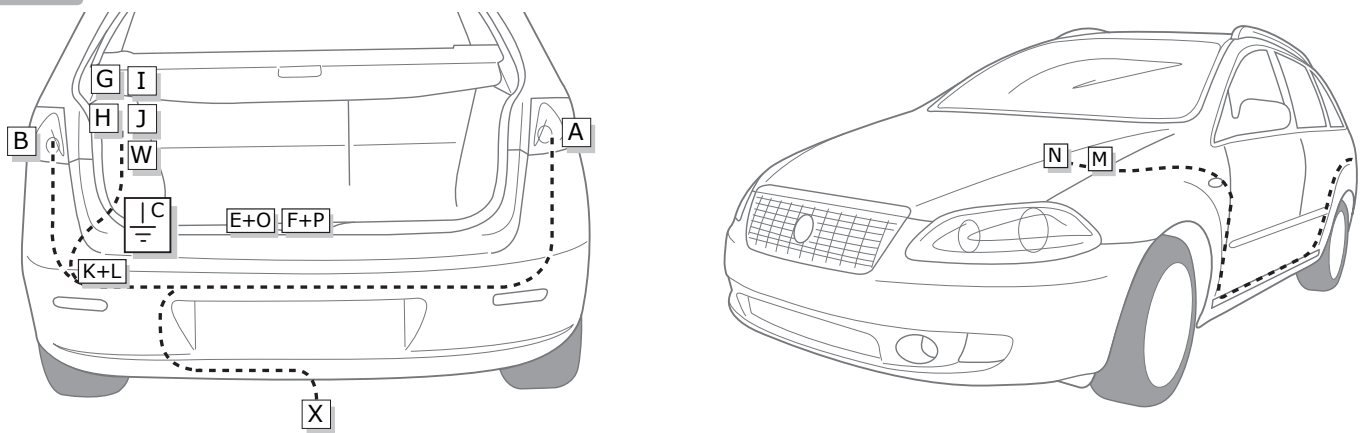

4

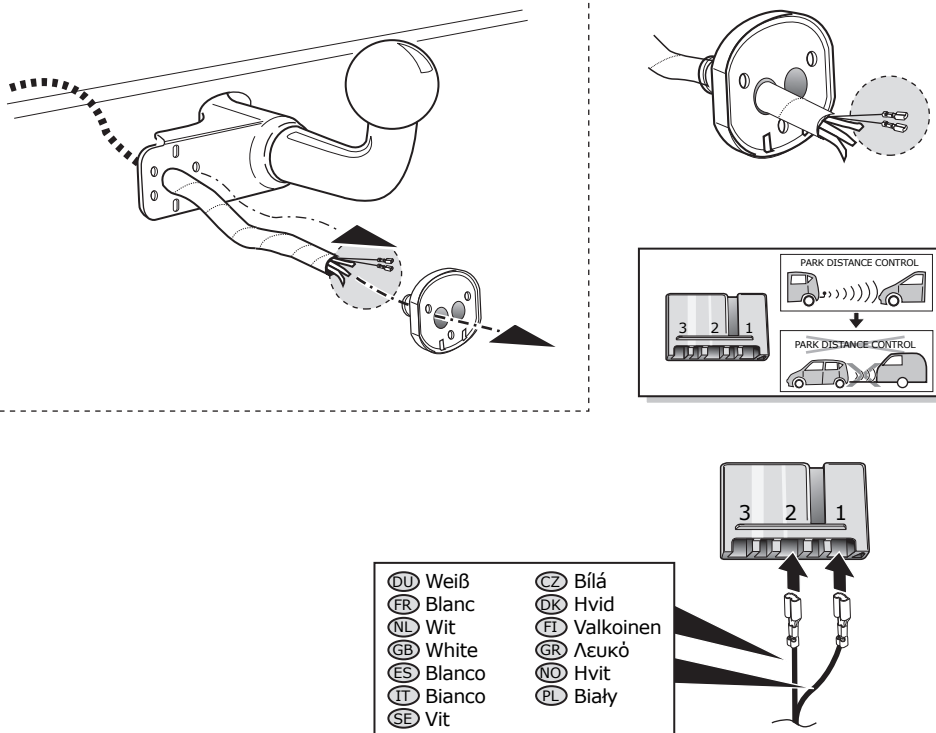

INFO

- DE Anschluss Steckdose
- FR Connection de la prise
- NL Contactdoos aansluiting
- GB Socket connection
- ES Conexión de la caja de enchufe
- IT Allaccio zoccolo
- SE Anslutning kontaktdosa
- CZ Objímkový konektor
- DK Stikdåse forbindelse
- FI Pistorasia liitäntä
- GR Υποδοχή σύνδεσης
- NO Tilkobling koblingsboks
- PL Połączenie przez gniazdo



Pag. 13

5

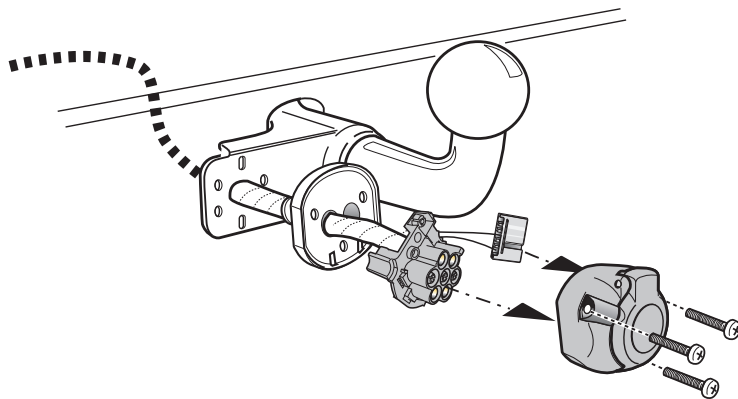

6

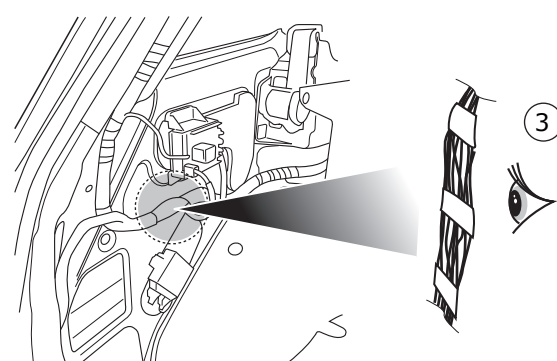
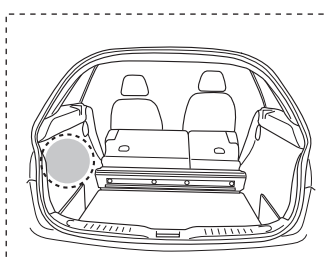
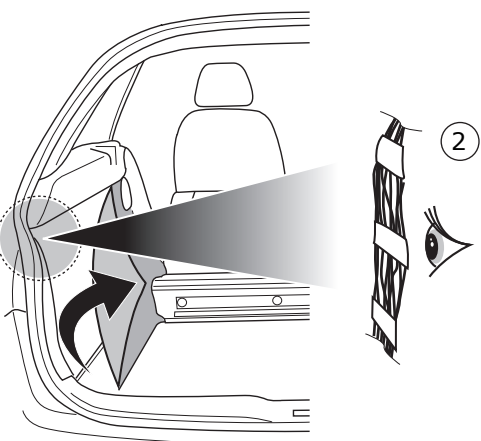
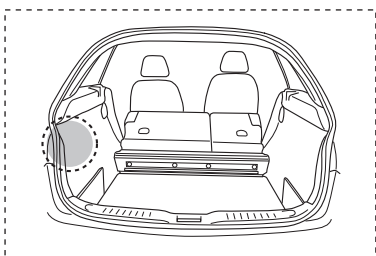
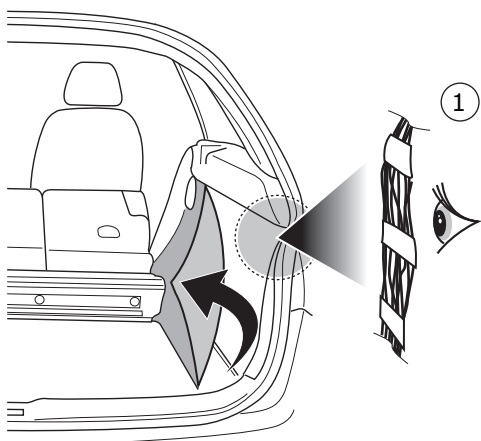
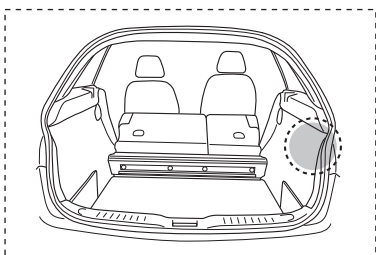

	DE Farben FR Couleurs NL Kleuren GB Colours ES Colores IT Colori SE Färgar	CZ Barevným DK Farverne FI Coloria GR χρώματα NO Farget PL Kolorować
① 54 STOP	
① 58R ☀️	
① R ➡️	
② 58L ☀️	
② L ➡️	
③ L ⓪≠	
③ R ⓪≠	

7

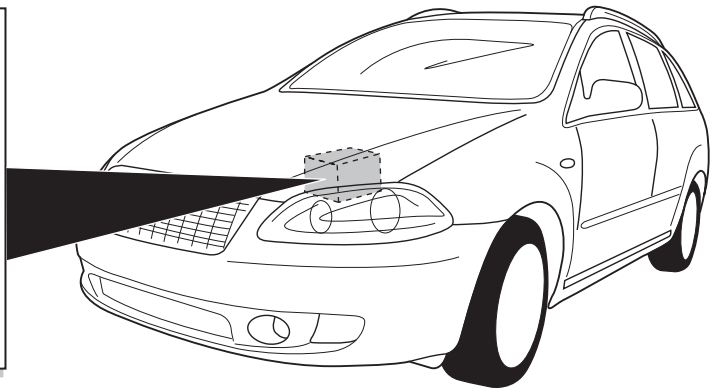
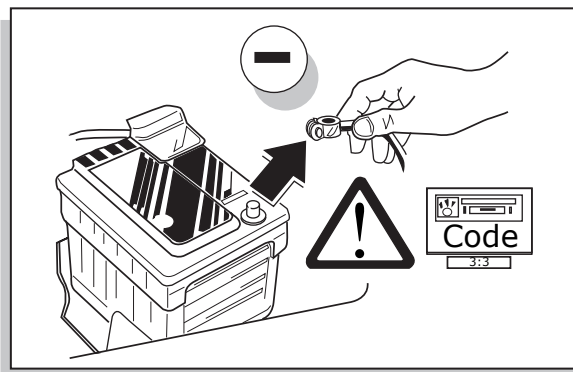

8

	<ul style="list-style-type: none"> • Farben • Couleurs • Kleuren • Colours • Colores • Colori • Färgar 	<ul style="list-style-type: none"> • Barevným • Farverne • Coloria • χρώματα • Färgel • Kolorować
① 54		
① 58R		
① R		
② 58L		
② L		
③ L		
③ R		

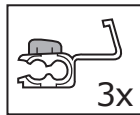

A

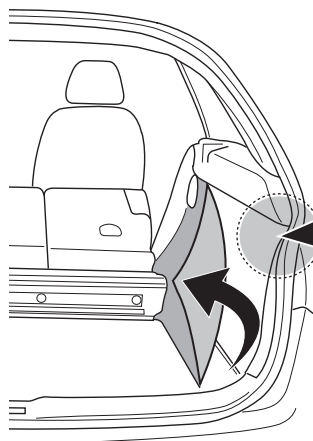

54 STOP

1

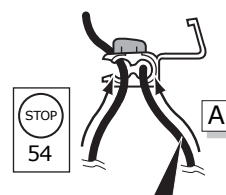

2



DE Blau/Rot	CZ Modrá/Červená
FR Blue/Rouge	DK Blå/Rød
NL Blauw/Rood	FI Sininen/Punainen
GB Blue/Red	GR Μπλε/Κόκκινο
ES Azul/Rojo	NO Blå/Rød
IT Blu/Rosso	PL Niebieski/Czerwony
SE Blå/Röd	

R →

1

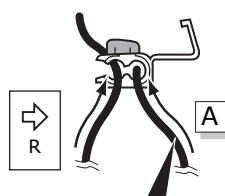

2



DE Schwarz/Grün	CZ Černá/Zelená
FR Noir/Vert	DK Sort/Grøn
NL Zwart/Groen	FI Musta/Vihreä
GB Black/Green	GR Μαύρο/Πράσινο
ES Negro/Verde	NO Svart/Grønn
IT Nero/Verde	PL Czarny/Zielony
SE Svart/Grön	

58R ☀

1

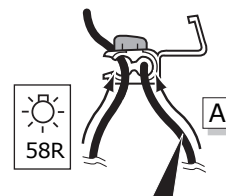

2



DE Schwarz/Braun	CZ Černá/Hnědá
FR Noir/Marron	DK Sort/Brun
NL Zwart/Bruin	FI Musta/Ruskea
GB Black/Brown	GR Μαύρο/Καφέ
ES Negro/Marrón	NO Svart/Brun
IT Nero/Marrone	PL Czarny/Brazowy
SE Svart/Brun	

	<ul style="list-style-type: none"> ● Farben ● Couleurs ● Kleuren ● Colours ● Colores ● Colori ● Färgar 	<ul style="list-style-type: none"> ● Bærvným ● Farverne ● Coloria ● χρώματα ● Farget ● Kolorować ● Färgar
① 54		
① 58R		
① R		
② 58L		
② L		
③ L		
③ R		

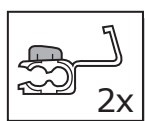
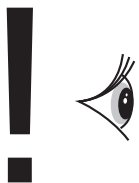

B

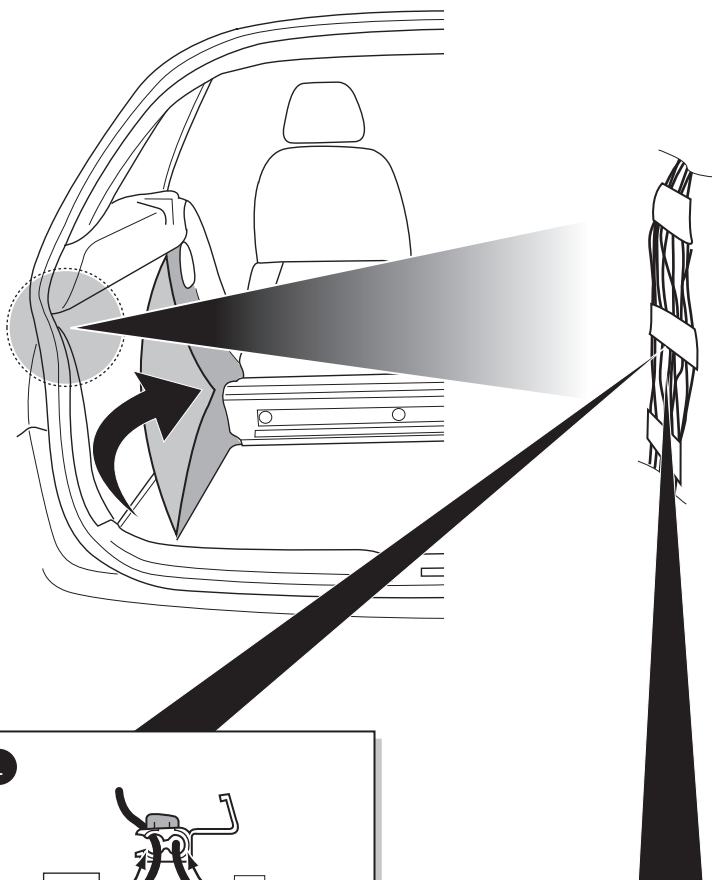

①

L

②

DE Schwarz/Gelb	CZ Černá/Žlutá
FR Noir/Jaune	DK Sort/Gul
NL Zwart/Geel	FI Musta/Keltainen
GB Black/Yellow	GR Μαύο/Κίτρινο
ES Negro/Amarillo	NO Svart/Gul
IT Nero/Giallo	PL Czarny/Żółty
SE Svart/Gul	

①

58L

58L

②

DE Violett/Schwarz	CZ Fialová/Černá
FR Violet/Noir	DK Lilla/Sort
NL Paars/Zwart	FI Purppura/Musta
GB Purple/Black	GR Μοβ/Μαύο
ES Morado/Negro	NO Lilla/Svart
IT Viola/Nero	PL Purpurowy/Czarny
SE Lila/Svart	

	Farben	Barevným
	Couleurs	Farverne
	Kleuren	Coloria
	Colours	χρώματα
	Colores	Farget
	Colori	Kolorować
	Färgar	

① S4		
① SBR		
① R		
② SBL		
② L		
③ L		
③ R		

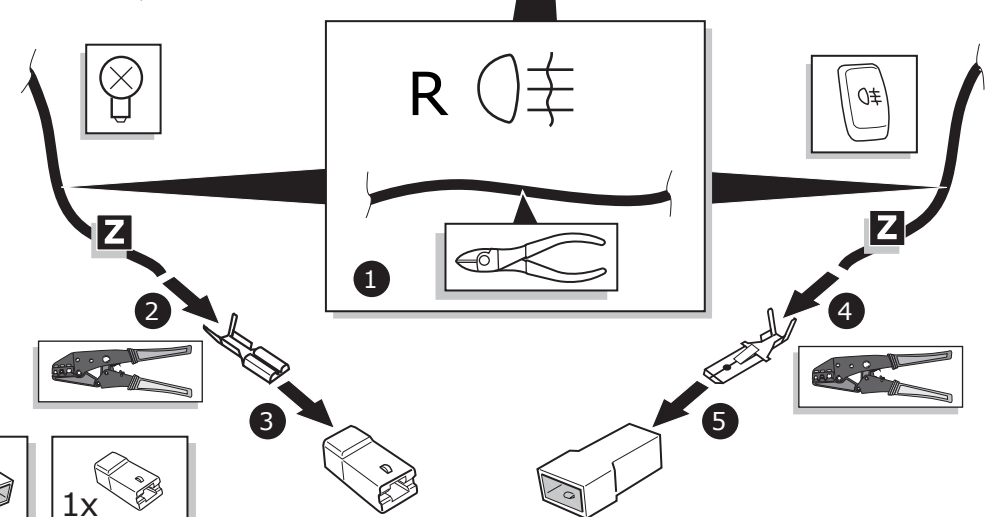
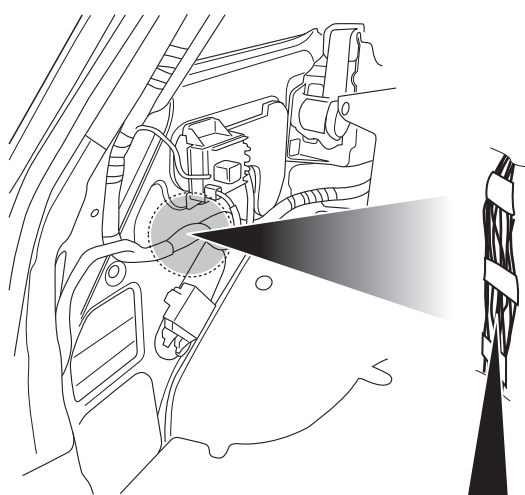

- 1x
- 1x
- 1x
- 1x

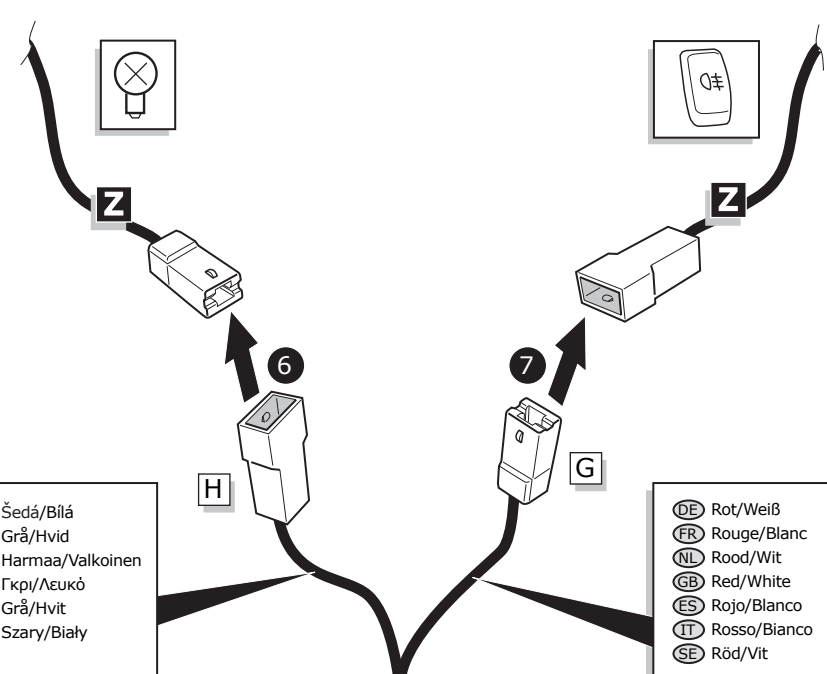

DE Grau/Weiß	CZ Šedá/Bílá
FR Gris/Blanc	DK Grå/Hvid
NL Grijs/Wit	FI Harmaa/Valkoinen
GB Grey/White	GR Γκρι/Λευκό
ES Gris/Blanco	NO Grå/Hvit
IT Grigio/Bianco	PL Szary/Biały
SE Grå/Vit	

DE Rot/Weiß	CZ Červená/Bílá
FR Rouge/Blanc	DK Rød/Hvid
NL Rood/Wit	FI Punainen/Valkoinen
GB Red/White	GR Κόκκινο/Λευκό
ES Rojo/Blanco	NO Rød/Hvit
IT Rosso/Bianco	PL Czerwony/Biały
SE Röd/Vit	

	● Farben	● Barevným
	● Couleurs	● Färverne
	● Kleuren	● Coloria
	● Colours	● χρώματα
	● Colores	● Farget
	● Colori	● Kolorować
	● Färgar	

① S4		
① 5BR		
① R		
② 5BL		
② L		
③ L		
③ R		

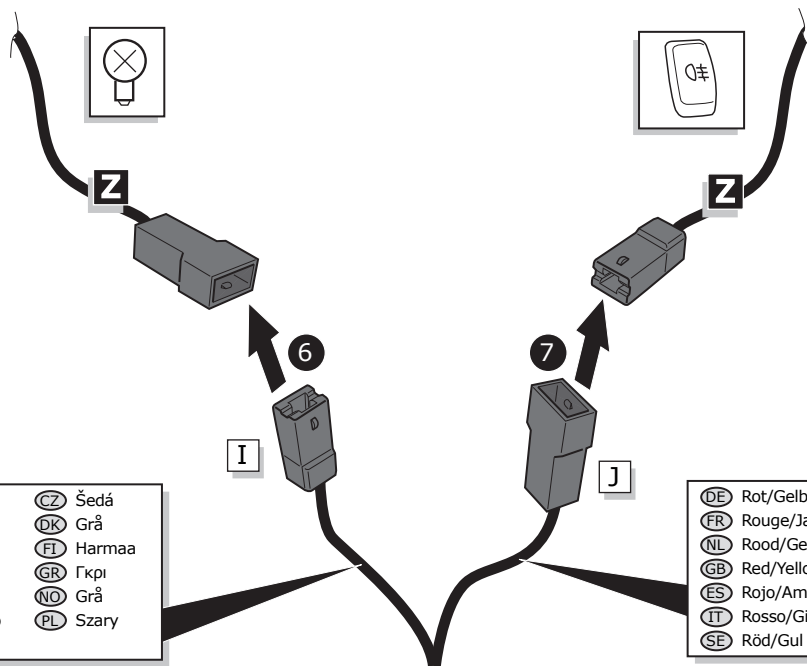
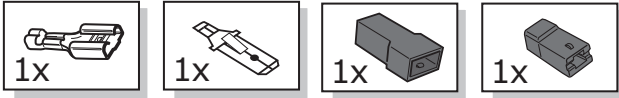
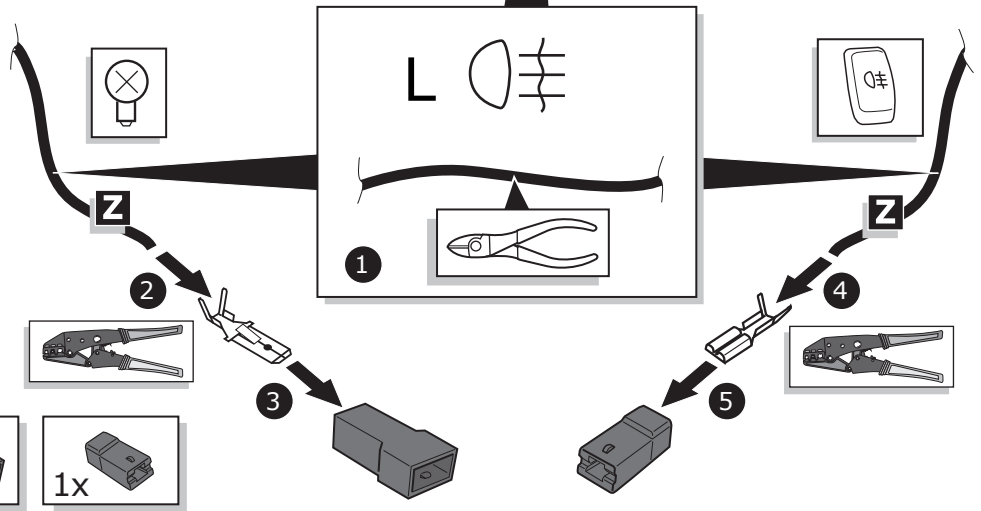
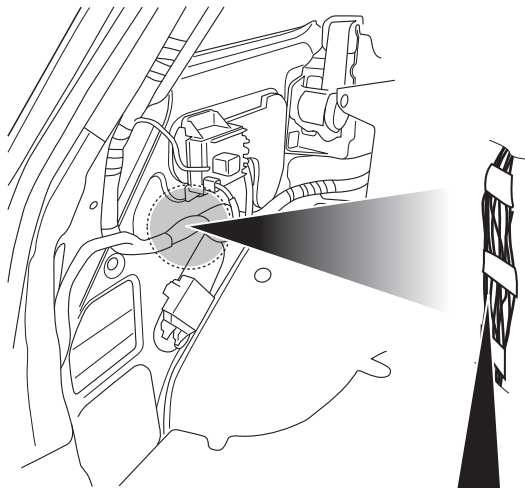

DE	Grau	CZ	Šedá
FR	Gris	DK	Grå
NL	Grijs	FI	Harmaa
GB	Grey	GR	Γκρι
ES	Gris	NO	Grå
IT	Grigio	PL	Szary
SE	Grå		

DE	Rot/Gelb	CZ	Červená/Žlutá
FR	Rouge/Jaune	DK	Rød/Gul
NL	Rood/Geel	FI	Punainen/Keltainen
GB	Red/Yellow	GR	Κόκκινο/Κίτρινο
ES	Rojo/Amarillo	NO	Rød/Gul
IT	Rosso/Giallo	PL	Czerwony/Żółty
SE	Röd/Gul		

12

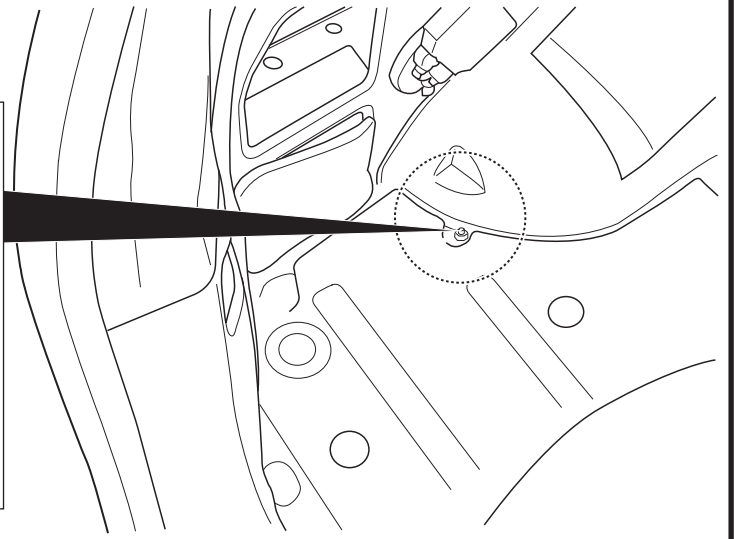
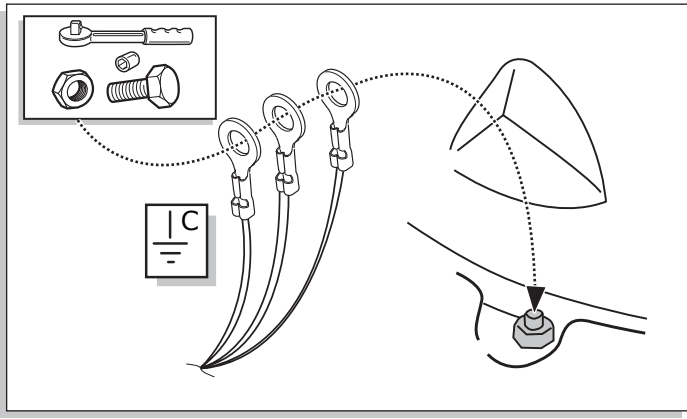

13

OPTION 1

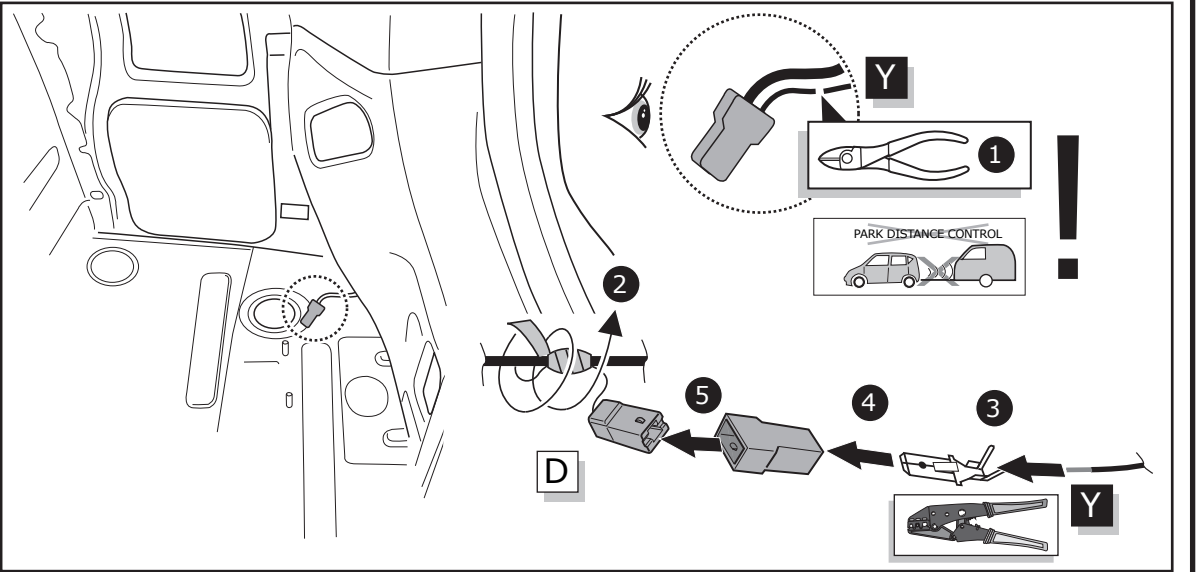
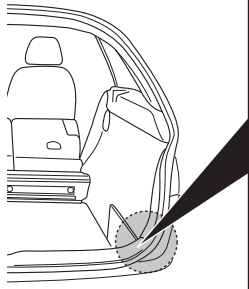
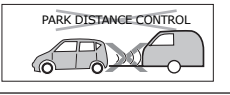

14

OPTION 2

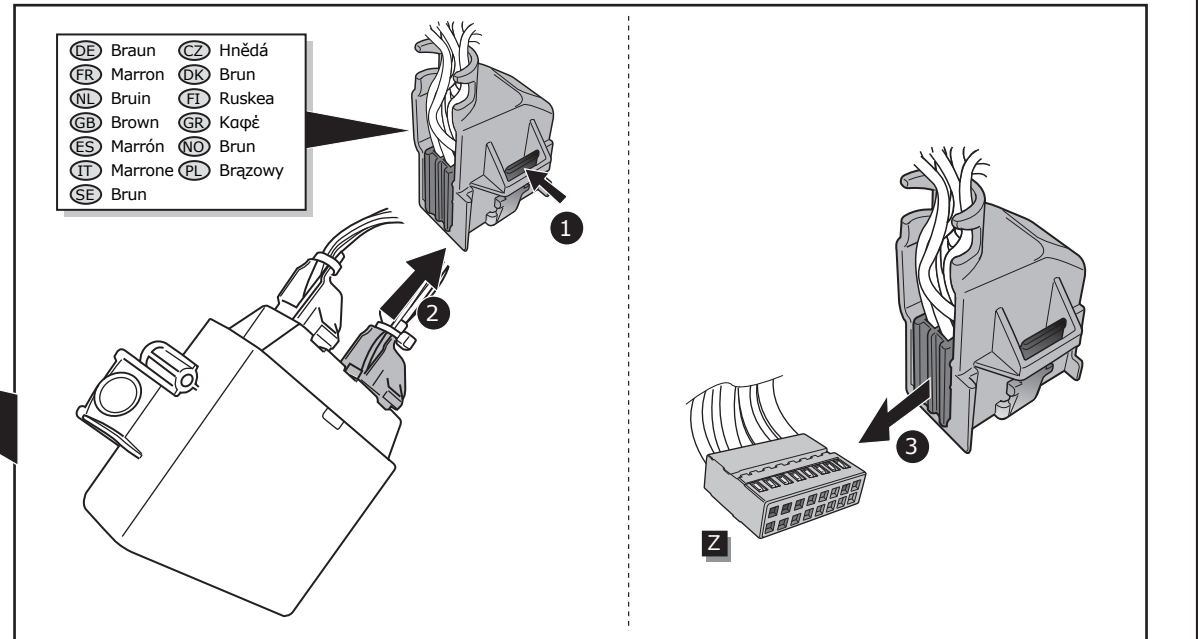
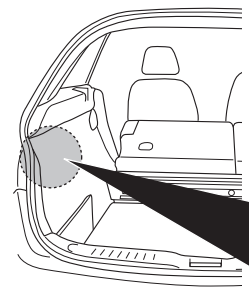
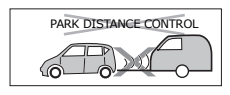

15

OPTION 2

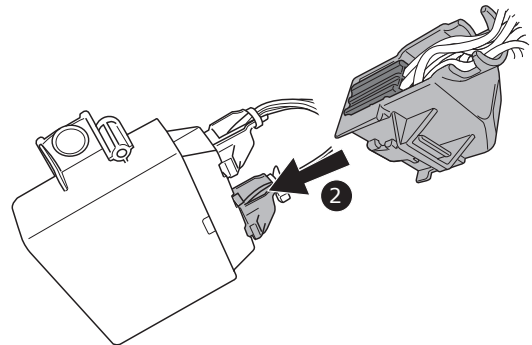
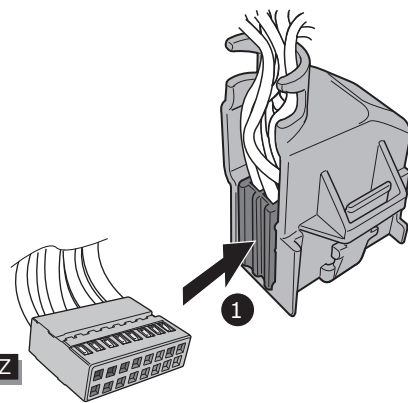
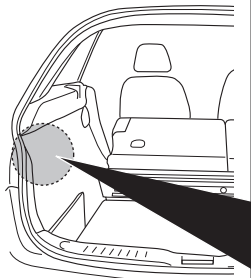
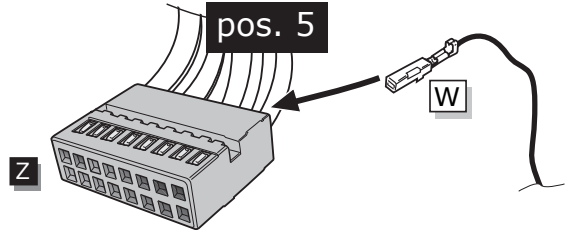
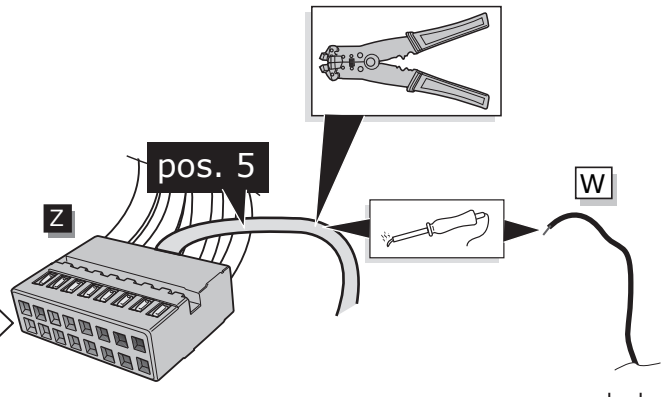
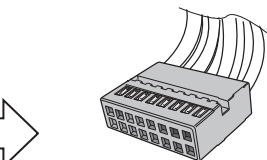
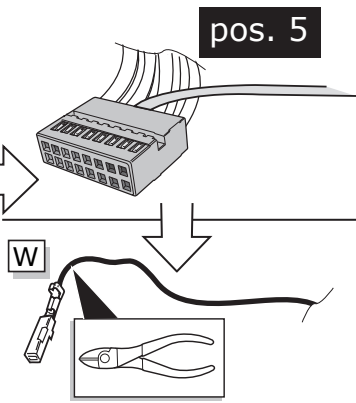
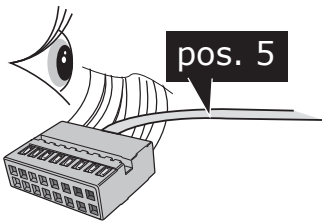

16

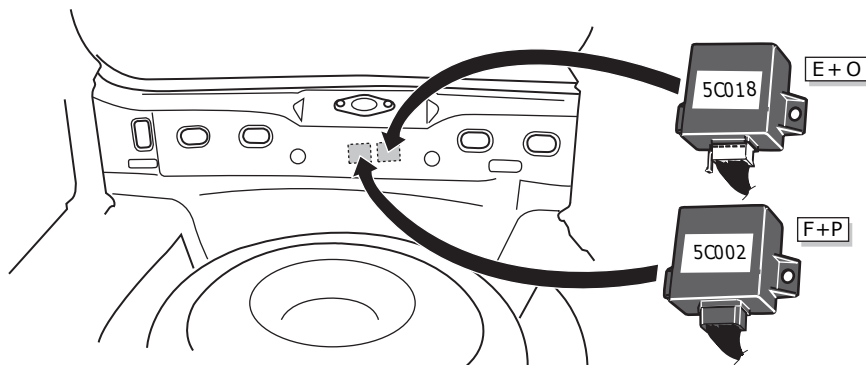
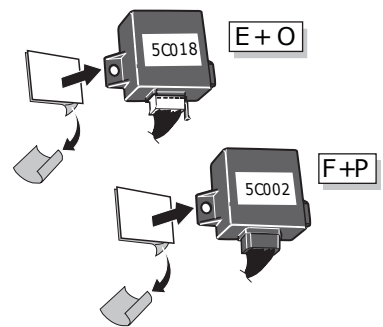
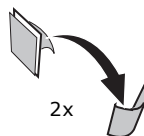
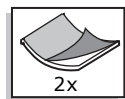
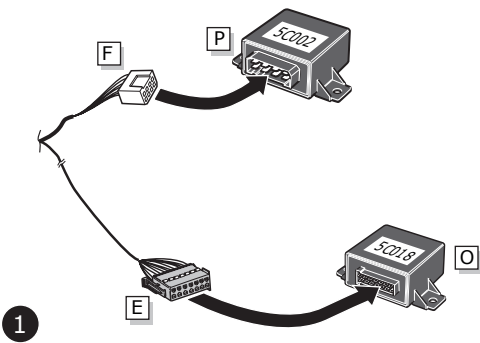

17

DE	Orange	CZ	Oranžová
FR	Orange	DK	Orange
NL	Oranje	FI	Oranssi
GB	Orange	GR	Πορτοκαλί
ES	Naranja	NO	Oransje
IT	Arancione	PL	Pomarańczowy
SE	Orange		

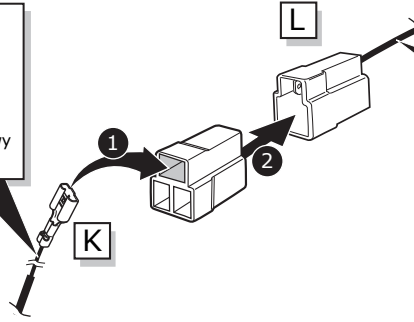

DE	Orange	CZ	Oranžová
FR	Orange	DK	Orange
NL	Oranje	FI	Oranssi
GB	Orange	GR	Πορτοκαλί
ES	Naranja	NO	Oransje
IT	Arancione	PL	Pomarańczowy
SE	Orange		

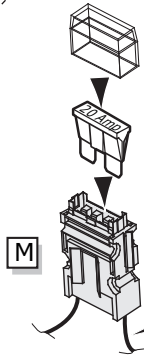

20 Amp

DE	Orange	CZ	Oranžová
FR	Orange	DK	Orange
NL	Oranje	FI	Oranssi
GB	Orange	GR	Πορτοκαλί
ES	Naranja	NO	Oransje
IT	Arancione	PL	Pomarańczowy
SE	Orange		

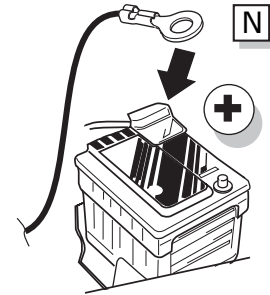

18

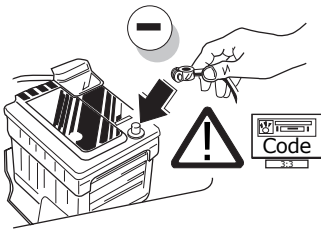

19

- DE** FUNKTIONEN KONTROLLIEREN MIT EINEM PRÜFGERÄT MIT WIDERSTAND ODER MIT LEUCHTEN MIT DER GENAUEN WATTZAHL!
- FR** CONTRÔLER LES FONCTIONS AVEC UNE BOÎTE DE TEST AVEC DE LA CHARGE OU DES LAMPES AVEC LA QUANTITÉ CORRECTE DE WATT!
- NL** CONTROLEER FUNCTIES MET EEN TESTER MET BELASTING OF LAMPEN MET DE JUISTE WATTAGE!
- GB** CHECK FUNCTIONS WITH A TESTBOX WITH LOAD OR LAMPS WITH THE RIGHT AMOUNT OF WATT!
- ES** ¡CONTROLAR FUNCIONES CON UN TESTER CON CARGA O LUCES CON EL CORRECTO WATTAGE!
- IT** CONTROLLA FUNZIONI CON UN TESTER CON CARICO O LAMPADIE DEL GIUSTO WATT-TAGGIO!
- SE** KONTROLLERA FUNKTIONERNA MED EN TESTARE MED BELASTNING ELLER LAMPOR MED RÄTT WATT-VÄRDE!
- CZ** OVĚŘTE FUNKCE POMOCÍ TESTOVACÍHO BOXU NEBO SVĚTEL S PŘÍSLUŠNÝM VÝKONEM!
- DK** CHECK FUNKTIONERNE MED EN TESTBOKS, MED BELASTNING ELLER MED LYGTER MED DET KORREKTE ANTAL WATT!
- FI** TARKISTA TOIMINNOT KÄYTTÄMÄLLÄ TESTILAITE, JOSSA ON OIKEATEHOINEN KUORMITUS TAI OIKEATEHOISET LAMPUT!
- GR** ΕΛΕΓΞΤΕ ΤΙΣ ΛΕΙΤΟΥΡΓΙΕΣ ΜΕ ΉΝΑ ΚΙΒΩΤΙΟ ΔΟΚΙΜΗΣ ΜΕ ΦΟΡΤΙΟ Ή ΛΑΜΠΙΡΕΣ ΣΩΣΤΗΣ ΠΟΣΟΤΗΤΑΣ ΒΑΤ!
- NO** KONTROLER FUNKSJONENE MED EN TESTER MED BELASTNING ELLER LYSPERER MED RIKTIG WATTVERDI!
- PL** SPRAWDŹ FUNKCJE UŻYWAJĄC SKRZYŃKI TESTOWEJ Z OBCIĄŻENIEM LUB PODŁĄCZONYMI ŻARÓWKAMI O ODPOWIEDNIEJ MOCY!



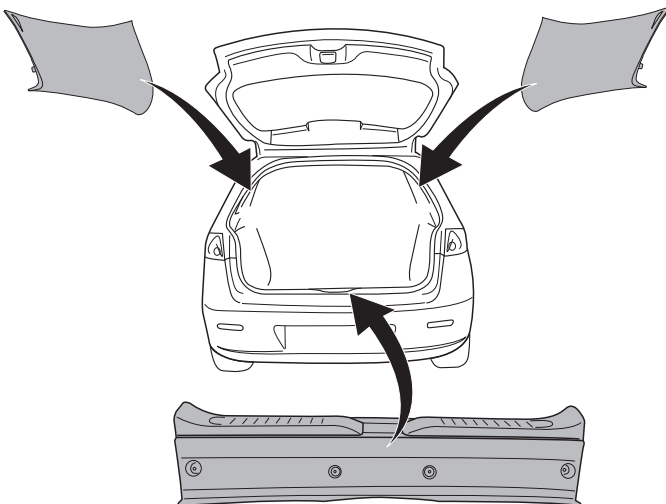

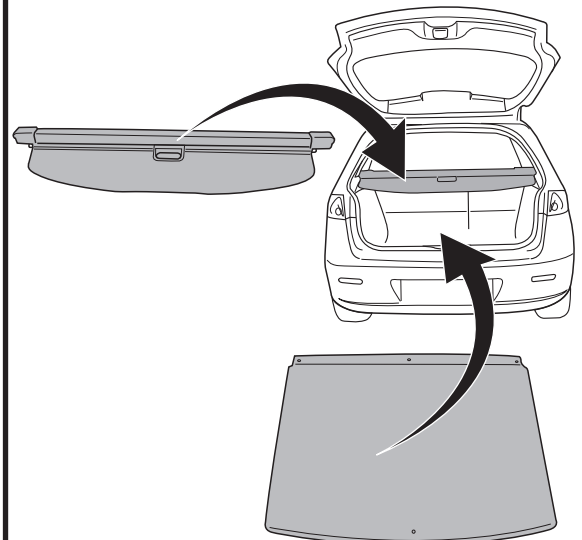

20



21

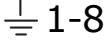

- (DU) Anschluss Steckdose
- (FR) Connection de la prise
- (NL) Contactdoos aansluiting
- (GB) Socket connection
- (ES) Conexión de la caja de enchufe
- (IT) Allaccio zoccolo
- (SE) Anslutning kontaktdosa
- (CZ) Objímkový konektor
- (DK) Stikdåse forbindelse
- (FI) Pistorasia liitäntä
- (GR) Υποδοχή σύνδεσης
- (NO) Tilkobling koblingsboks
- (PL) Połączenie przez gniazdo

DIN/ISO 1724							
	1/L	2	3/31	4/R	5/58-R	6/54	7/58-L
Pmax	21W	2x21W		21W	52W	3x21W	52W
(DE)	Gelb	Blau	Weiß	Grün	Braun	Rot	Schwarz
(FR)	Jaune	Bleu	Blanc	Vert	Marron	Rouge	Noir
(NL)	Geel	Blauw	Wit	Groen	Bruin	Rood	Zwart
(GB)	Yellow	Blue	White	Green	Brown	Red	Black
(ES)	Amarillo	Azul	Blanco	Verde	Marrón	Rojo	Negro
(IT)	Giallo	Blu	Bianco	Verde	Marrone	Rosso	Nero
(SE)	Gul	Blå	Vit	Grön	Brun	Röd	Svart
(CZ)	Žlutá	Modrá	Bílá	Zelená	Hnědá	Červená	Černá
(DK)	Gul	Blå	Hvid	Grøn	Brun	Rød	Sort
(FI)	Keltainen	Sininen	Valkoinen	Vihreä	Ruskea	Punainen	Musta
(GR)	Κίτρινο	Μπλε	Λευκό	Πράσινο	Καφέ	Κόκκινο	Μαύρο
(NO)	Gul	Blå	Hvit	Grønn	Brun	Rød	Svart
(PL)	Żółty	Niebieski	Biały	Zielony	Brązowy	Czerwony	Czarny