

8

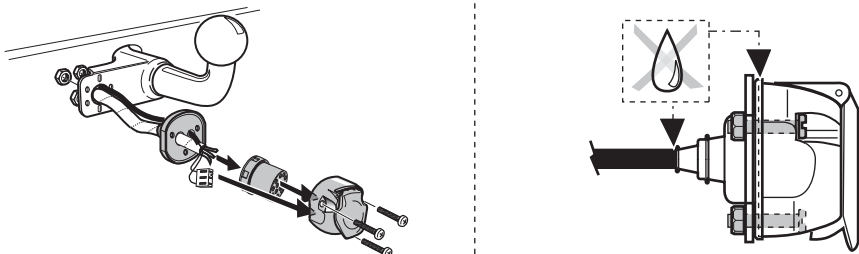

**Anschluss Steckdose / Connection de la prise / Socket connection /  
Contactdoos aansluiting / Allaccio zoccolo / Połączenie przez gniazdo**

**INFO**

DIN/ISO 11446	DE	FR	GB	NL	IT	PL	Pmax
	1/L gelb	jaune	yellow	geel	giallo	żółty	21W
	2 blau	bleu	blue	blauw	blu	niebieski	2x21W
	2a grau	gris	grey	grijs	grigio	szary	
	3/31 weiß	blanc	white	wit	bianco	biały	
	4/R grün	vert	green	groen	verde	zielony	21W
	5/58-R braun	marron	brown	bruin	marrone	brązowy	52W
	6/54 rot	rouge	red	rood	rosso	czerwony	3x21W
	7/58-L schwarz	noir	black	zwart	nero	czarny	52W
	8 schwarz/rot	noir/rouge	black/red	zwart/rood	nero/rosso	czarny/czerwony	2x21W
	9 braun/weiß	marron/blanc	brown/white	bruin/wit	marrone/bianco	brązowy/biały	180W / 15Amp
	10 rot	rouge	red	rood	rosso	czerwony	180W / 15Amp
	11 weiß	blanc	white	wit	bianco	biały	
	12						
	13 weiß	blanc	white	wit	bianco	biały	

9

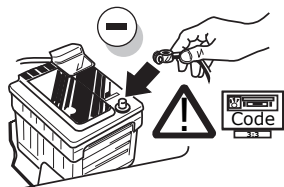

10

- DE FUNKTIONEN KONTROLLIEREN !**  
**FR CONTRÔLER LES FONCTIONS !**  
**GB CHECK FUNCTIONS !**  
**NL CONTROLEER FUNCTIES !**  
**IT CONTROLLA FUNZIONI !**  
**PL SPRAWDŹ FUNKCJE !**

11

- DE Einzelteile wieder einbauen.**  
**FR Montez les part enlèves.**  
**GB Reinstall linings.**  
**NL Terug plaatsen onderdelen.**  
**IT Rimetti a posto componenti.**  
**PL Założyć wykładzinę.**

**FIAT IDEA  
Nr.: FI-010-ZT**

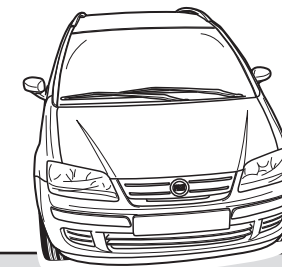
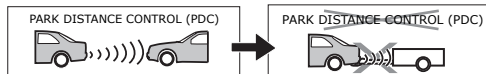

- \* Einzelteilliste \* Liste de pieces \* Part list  
 \* Onderdelenlijst \* Elenco componenti \* Lista części

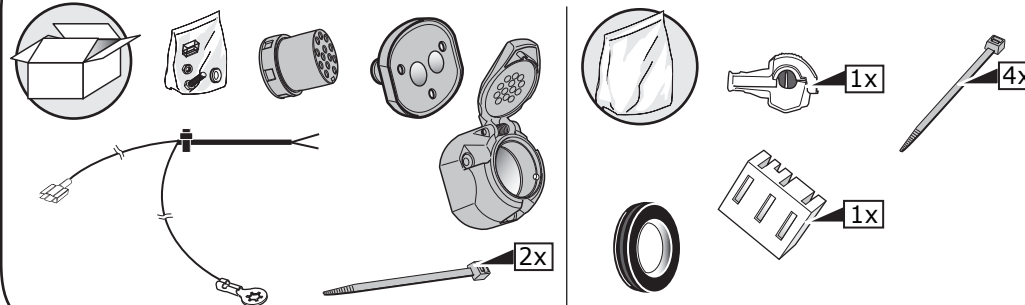

- DE Einbauanleitung Elektrosatz  
Anhängervorrichtung mit 13-P Steckdose  
lt. DIN/ISO Norm 11446**

- NL Montage-handleiding elektrokabelset  
voor trekhaak met 13-P contactdoos  
vlg. DIN/ISO norm 11446**

- FR Instructions de montage du faisceau électrique  
pour crochet d'attelage conforme  
à la norme DIN/ISO 11446 prise 13-P**

- IT Istruzioni di montaggio di set di cavi elettrici  
per gancio da traino con zoccolo a 13-P  
conforme alla norma DIN/ISO 11446**

- GB Fitting instructions electric wiringkit  
towbar with 13-P socket  
up to DIN/ISO norm 11446**

- PL Instrukcje montażu zestawu okablowania  
elektrycznego dyszla holowniczego  
z 13-stykowym gniazdem DIN/ISO 11446**

- DE** Wir weisen ausdrücklich darauf hin, dass eine unsachgemäße und nicht in einer Fachwerkstatt durchgeführte Montage einen Verzicht auf Entschädigung jeglicher Art insbesondere bezüglich des Produkthaftpflichtrechts zur Folge hat. Technische Änderungen vorbehalten. Widerstand nur gemäß der Tabelle auf dem Anhänger verwenden, siehe Seite 4.

- FR** Il est expressément prévu qu' on ne saurait se prévaloir d'un quelconque préjudice contractuel ou rédhibitoire si le montage a été effectué en dépit des dites instructions ou dans un garage ne disposant pas des équipements adéquats. Sous réserve de modifications techniques. N'excédez pas la charge maximale, indiquée dans le d'un véhicule tracté, voir en page 4.

- GB** We would expressly point out that assembly not carried out properly and by a specialist workshop will result in cancellation of any right to damage compensation, in particular those arising by virtue of the product liability act. Subject to technical changes without notice. Only use loads according to the connection table on the towed vehicle (see page 4).

- NL** Wij wijzen er met nadruk op, dat ondeskundige en niet door een vakkundige werkplaats uitgevoerde montage tot gevolg heeft dat daardoor ieder recht op schadevergoeding, ook op wettelijke aansprakelijkheid inzake producten, vervalt. Technische wijzigingen voorbehouden. Gebruik alleen belasting volgens aansluittabel op het getrokken voertuig, zie pagina 4.

- IT** Sottolineiamo espressamente che un montaggio inadeguato ed eseguito da un'officina non specializzata ha come conseguenza il decadere di qualsiasi diritto al risarcimento danni, nonché alla responsabilità legale relativa ai prodotti. Ci si riserva il diritto di apportare modifiche tecniche. Utilizzare esclusivamente un carico conforme alla tabella degli allacci relativa al veicolo in questione, cfr. pagina 4.

- PL** Chcielibyśmy wyraźnie zaznaczyć, iż wszelki nieprawidłowy montaż, który nie jest wykonywany w specjalistycznym warsztacie pociąga za sobą utratę możliwości dochodzenia wszelkiego typu roszczeń, w szczególności tych wynikających z odpowiedzialności producenta za swój produkt. Podlega zmianom bez powiadomienia. Używać tylko takiego maksymalnego obciążenia które wynika z tabliczki połączeń holowanego pojazdu, patrz strona 4.

1

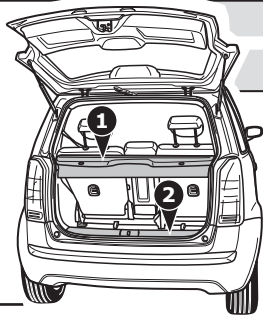
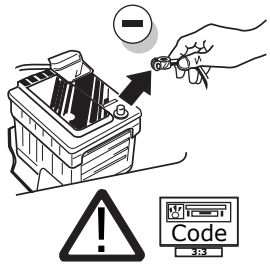

DE

Einzelteile abmontieren

FR

Démontez les parts

GB

Remove linings

NL

Verwijder onderdelen

IT

Rimuovi componenti

PL

Zdjąć wykładzinę

INFO

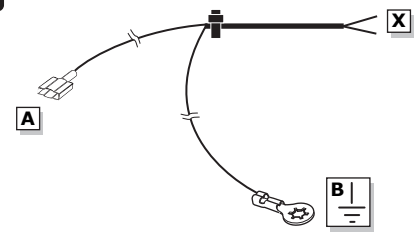

ROUTING

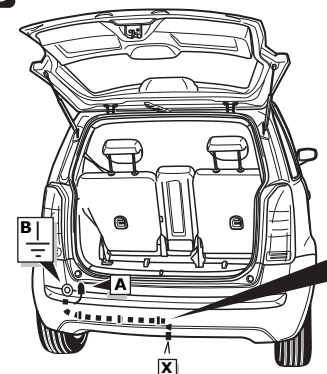

4

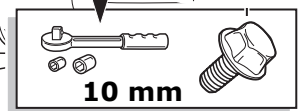
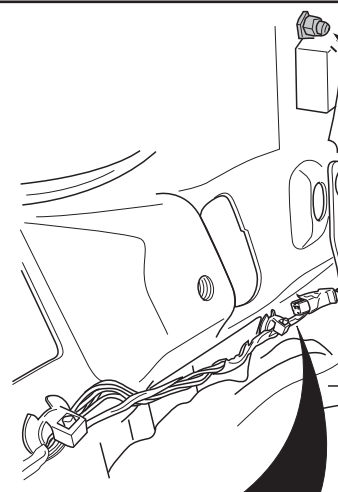

5

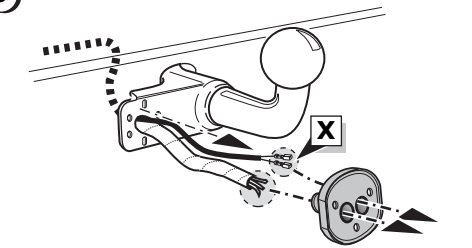

Weiß  
Blanc  
White  
Wit  
Bianco  
Biały

2

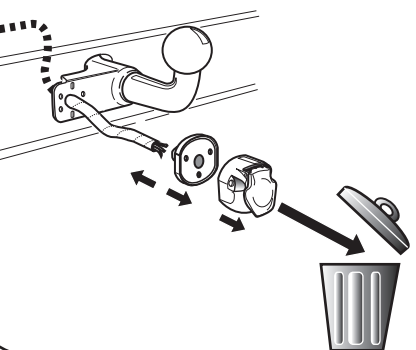
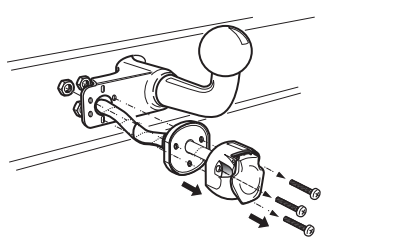

3

Blaü/Schwarz  
Bleu/Noir  
Blue/Black  
Blauw/Zwart  
Blu/Nero  
Niebieski/Czarny

PARK DISTANCE CONTROL (PDC)

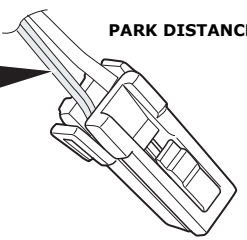

1



2

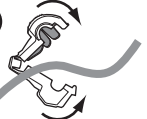

3

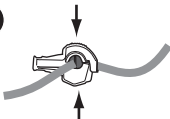

4

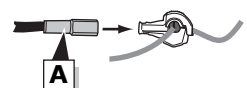

A

6

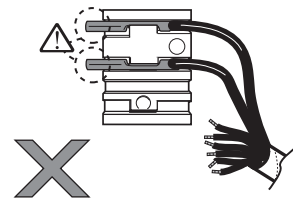

X

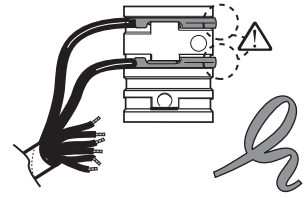

7

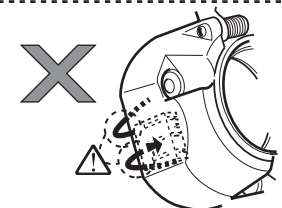

X

