

BMW 5 Series E60 07/2003 >> 02/2014
BMW 5 Series E61 03/2004 >> 02/2014

Partnr.: BW-008-H1

DE

• Einbauanleitung Elektrosatz Anhängervorrichtung mit 13-P Steckdose lt. DIN/ISO Norm 11446. • Wir weisen ausdrücklich darauf hin, dass eine unsachgemäße und nicht in einer Fachwerkstatt durchgeführte Montage einen Verzicht auf Entschädigung jeglicher Art insbesondere bezüglich des Produkthaftpflichtrechts zur Folge hat. • Technische Änderungen vorbehalten. • Widerstand nur gemäß der Tabelle auf dem Anhänger verwenden. • Achtung! Bitte lesen Sie vorab diese Anleitung, nehmen Sie diese zur Kenntnis und verweisen Sie Ihren Kunden auf das Bedienbuch bezgl. der eventuell zu treffenden Maßnahmen zum Ziehen eines Anhängers. • Bei Funktionsproblemen ist die Fehlersuche auf ca. 0,5 Stunden zu begrenzen, kontaktieren Sie die ECS Technical Support: ts@ecs-electronics.nl / 00800 22552327

FR

• Instructions de montage du faisceau électrique pour crochet d'attelage conforme à la norme DIN/ISO 11446 prise 13-P. • Il est expressément prévu qu'il ne saurait se prévaloir d'un quelconque préjudice contractuel ou réhibitoire si le montage avait été fait en dépit des dites instructions ou dans un garage ne disposant pas des équipements adéquats. • Sous réserve de modifications techniques. • Ne excédez pas la charge maximale, indiquée dans le tableau. • Attention! Avant de commencer le branchement, on vous prie de prendre compte des connections à faire dans la notice, ainsi que communiquer directement à votre client les mesures à prendre pour tirer une remorque. • S'il y a des problèmes de fonctionnement, limiter la recherche de défauts à env. 30 minutes et contacter ECS l'Aide en ligne: ts@ecs-electronics.nl / 00800 22 55 23 27.

NL

• Montage-handleiding elektrokabelset voor trekhaak met 13-P contactdoos vlg. DIN/ISO norm 11446. • Wij wijzen er met nadruk op, dat ondeskundige en niet door een vakkundige werkplaats uitgevoerde montage tot gevolg heeft dat daardoor ieder recht op schadevergoeding, ook op wettelijke aansprakelijkheid inzake producten, vervalt. • Technische wijzigingen voorbehouden. • Gebruik alleen belasting volgens aansluittabel op het getrokken voertuig. • Opgelet! Wij verzoeken U dringend vooraf deze instructie door te nemen, hiervan kennis te nemen en uw cliënt te verwijzen naar het instructieboekje betreffende de eventueel te nemen maatregelen voor het trekken van een aanhangwagen. • Bij werkingsproblemen moet de foutencontrole tot ca. 0,5 uur beperkt worden, neem contact op met de ECS Technical Support: ts@ecs-electronics.nl / 00800 22 55 23 27.

GB

• Fitting instructions electric wiring kit tow bar with 13-P socket up to DIN/ISO Norm 11446. • We would expressly point out that assembly not carried out properly by a competent installer will result in cancellation of any right to damage compensation, in particular those arising by virtue of the product liability act. • Contents of these kits and their fitting manuals are subject to alteration without notice, please ensure that these instructions are read and fully understood before commencing installation. • Do not overload circuits; the maximum loads per connection are detailed in this manual. • Attention! Before Installation, please read this manual carefully and inform your customer to consult the vehicle owners manual to check for any vehicle modifications required before towing. • In the event of functional problems, troubleshooting must be limited to about 0.5 hours, contact the ECS Technical Support: ts@ecs-electronics.nl / 00800 22 55 23 27.

ES

• Instrucciones de montaje de kit eléctrico para enganche de remolque con caja de conexiones 13-P según norma DIN/ISO 11446. • El montaje inapropiado y efectuado por personal no cualificado originará la pérdida de todo derecho a indemnización o la expiración de toda responsabilidad civil con respecto al producto. • Nos reservamos el derecho a efectuar modificaciones técnicas. • Utilice sólo cargas de acuerdo a la tabla de conexión del vehículo remolcado. • Atención: lea atentamente este manual antes de la instalación e informe al cliente que debe consultar el manual de usuario del vehículo para conocer cualquier modificación realizada. • En caso de tener problemas con su funcionamiento, la búsqueda de errores está limitada a aprox. 0,5 horas, por lo que le recomendamos ponerse en contacto con el servicio de atención telefónica: ts@ecs-electronics.nl / 00800 22 55 23 27.

IT

• Istruzioni di montaggio di set di cavi elettrici per gancio da traino con zoccolo a 13-P conforme alla norma DIN/ISO 11446. • Sottolineiamo espressamente che un montaggio inadeguato ed eseguito da un'officina non specializzata ha come conseguenza il decadere di qualsiasi diritto al risarcimento danni, nonché alla responsabilità legale relativa ai prodotti. • Ci si riserva il diritto di apportare modifiche tecniche. • Utilizzare esclusivamente un carico conforme alla tabella degli allacci relativa al veicolo in questione. • Attenzione! Vi invitiamo a leggere attentamente questo manuale e a invitare a vostra volta i clienti a leggere il manuale del conducente sulle eventuali misure da prendere per l'attacco di un rimorchio. • In caso di problemi di funzionamento, la ricerca di errori dovrebbe essere limitata a circa 0,5 ore. Contattare il centralino di assistenza per i fasci di cavi: ts@ecs-electronics.nl / 00800 22 55 23 27.

SE

• Monteringsanvisningar elkabelsats för dragkrok med 13-P kontaktdosa enligt DIN/ISO norm 11446. • Vi påpekar med eftertryck att all rätt till skadeersättning och all laglig ansvarighet förfaller om monteringen inte har utförts på rätt sätt och av en professionell verkstad. • Tekniska ändringar förbehålles. • Använd endast belastning enligt anslutningstabellen på det dragna fordonet. • Varning! Innan installation, läs den här handboken noga och informera din kund om att läsa fordonets användarhandbok för att undersöka vilka eventuella ändringar som behöver göras på fordonet. • Vid funtionsproblem ska felsökningen begränsas till ca 0,5 timme, kontakta reservdels-helpline ts@ecs-electronics.nl / 00800 22 55 23 27.

CZ

• Montážní pokyny: souprava pro elektrické propojení tažné tyče s 13-P zásuvkou do normy DIN/ISO 11446. • Výslovně zdůrazňujeme, že jakákoli montáž, která není provedená ve specializované dílně, má za následek odvolání nároků na kompenzaci jakéhokoli druhu, obzvláště vyplývajících ze zákona o odpovědnosti za způsobené škody. • Změny mohou být provedeny bez oznámení. • Používejte pouze při maximálním nabití podle tabulky na tažném vozidle. • Upozornění! Prosíme, abyste si nejdříve přečetli tyto instrukce, seznámili se s nimi a odkázali své zákazníky na příručku týkající se případných opatření, která musí být přijata pro tažení přívěsu. • Při problémech funkčnosti je třeba vyhledávání chyb omezit na cca 0,5 hodiny, kontaktujte ECS Technical Support: ts@ecs-electronics.nl / 00800 22 55 23 27.

DK

• Monteringsvejledninger for det elektriske ledningsføringssæt for trækstang med 13-P stikdåse, DIN/ISO, norm 11446. • Vi ønsker at gøre udtrykkeligt opmærksom på atferket samling, der ikke er udført af et specialiseret værksted, resulterer i bortfaldelse af kompensationskrav af alle slags, i særdeleshed krav der måtte opstå omkring det lovlige ansvar. • Kan ændres uden varsel. • Brug kun den maksimale belastning, i overensstemmelse med forbindelsestabelen for bugserede køretøjer. • OBS! For installation skal denne vejledning læses omhyggeligt og din kunde skal informeres om at kigge i køretøjets håndbog for at kontrollere om der skal laves eventuelle ændringer på køretøjet inden bugsering. • Ved funktionsproblemer skal fejlsøgningen begrænses til ca. 0,5 time, kontakt ECS Technical Support: ts@ecs-electronics.nl / 00800 22 55 23 27.

FI

• Ohjeet vetokoukun sähkökaapelisarjan asentamiseen, jossa on DIN/ISO 11446 mukainen 13-P liitin. • Korostamme, että kaikki oikeudet vahinkokorvaukseen kuten myös valmistajan laillinen vastuu raukeavat, mikäli asennusta ei ole toteutettu oikealla tavalla eikä ammattitaitoisen asiantuntijan toimesta. • Oikeus teknisiin muutoksiin ilman erillistä huomautusta pidätetään. • Huomio! Lue tämä käyttöopas huolellisesti ennen asennusta ja tiedota asiakkaita tarkistamaan kaikki ajoneuvon muutoksen ajoneuvon omistajan käyttöoppaas ennen hinausta. • Kuormita työvirtapiiriä ainoastaan hinattavan ajoneuvon kytkentäkaavin mukaisesti. • Virhehaku on rajoitettava toiminto-ongelmien esiintyessä noin 0,5 tuntiin, ota yhteys ECS Technical Support: ts@ecs-electronics.nl / 00800 22 55 23 27.

GR

• Οδηγίες συναρμολόγησης ηλεκτρικού σετ καλωδίων μπάρας ρυμούλκησης με υποδοχή 13-P μέτρι DIN/ISO Κανόνας 11446. • Επισημαίνουμε κατηγορηματικά ότι οποιαδήποτε ασφαλή συναρμολόγηση, η οποία δεν έχει πραγματοποιηθεί ειδικό εργαστήριο θα οδηγήσει σε αποποίηση των αξιώσεων επιβολής αποζημιώσεων οποιοδήποτε είδους, ειδικά όσα προκύπτουν από το νόμο ευθύνης προϊόντων. • Μπορεί να τροποποιηθεί χωρίς προηγούμενη ειδοποίηση. • Χρησιμοποιείτε μόνο μέγιστο ηλεκτρικό φορτίο σύμφωνα με τον πίνακα σύνδεσης στο ρυμούλκούμενο όχημα. • Προσοχή! Πριν την εγκατάσταση, διαβάστε το εγχειρίδιο αυτό προσεκτικά και ενημερώστε τον πελάτη σας να συμβουλευτεί το εγχειρίδιο ιδιοκτητήτων οχήματος ώστε να ελεγχθεί τυχόν τροποποιήσεις που απαιτούνται στο όχημα πριν τη ρυμούλκηση. • Σε περίπτωση προβλημάτων λειτουργίας να περιοριστεί η αναζήτηση σφαλμάτων σε περί. 0,5 δευτ., επικοινωνήστε με τη γραμμή υποστήριξης ECS Technical Support: ts@ecs-electronics.nl / 00800 22 55 23 27.

NO

• Monteringsanviser elkabelsett for trekkrok med 13-P koblingsboks ifølge DIN/ISO norm 11446. • Vi påpeker ettertrykkelig at all rett til skadeerstatning og rettslig ansvar forfaller dersom monteringen ikke er blitt utført på riktig måte og av et profesjonelt verksted. • Tekniske endringer forbeholdes. • Overskrid ikke grensene anviset i tilkoblingstabellen på tilhengeren eller det tilkoblede kjøretøyet. • OBS! Les denne bruksanvisningen nøye før installasjon. Be kunden om å rådføre seg med brukerhåndboken for kjøretøyeiere for å sjekke om kjøretøyet må modifiseres før tauing. • Ved funksjonsproblemer må feilsøket begrenses til ca. 0,5 timer, kontakt ECS Technical Support: ts@ecs-electronics.nl / 00800 22 55 23 27.

PL

• Instrukcje montażu zestawu okablowania elektrycznego dysza holowniczego z 13-P stykowym gniazdem DIN/ISO 11446. • Chcielibyśmy wyraźnie zaznaczyć, iż wszelki nieprawidłowy montaż, który nie jest wykonywany w specjalistycznym warsztacie pociąga za sobą utratę możliwości dochodzenia wszelkiego typu roszczeń, w szczególności tych wynikających z odpowiedzialności producenta za swój produkt. • Podlega zmianom bez powiadomienia. • Używać tylko takiego maksymalnego obciążenia które wynika z tabliczki połączeń holowanego pojazdu. • Uwaga! Przed zainstalowaniem należy dokładnie przeczytać tę instrukcję i poinformować klienta o konieczności sprawdzenia w instrukcji posiadacza pojazdu w celu sprawdzenia przed holowaniem, czy nie wprowadzono do pojazdu jakichkolwiek zmian. • W przypadku problemów ograniczyć wyszukiwanie błędów do ok. 0,5 godziny, skontaktować się z linią serwisową ts@ecs-electronics.nl / 00800 22 55 23 27.

Einzelteilliste

Liste de pièces

Onderdelenlijst

Part list

Lista de componentes

Elenco componenti

Dellista

Seznam dílů

Del-liste

Osaluettelo

Κατάλογος εξαρτημάτων

Delliste

Lista części

(DE)

(FR)

(NL)

(GB)

(ES)

(IT)

(SE)

(CZ)

(DK)

(FI)

(GR)

(NO)

(PL)

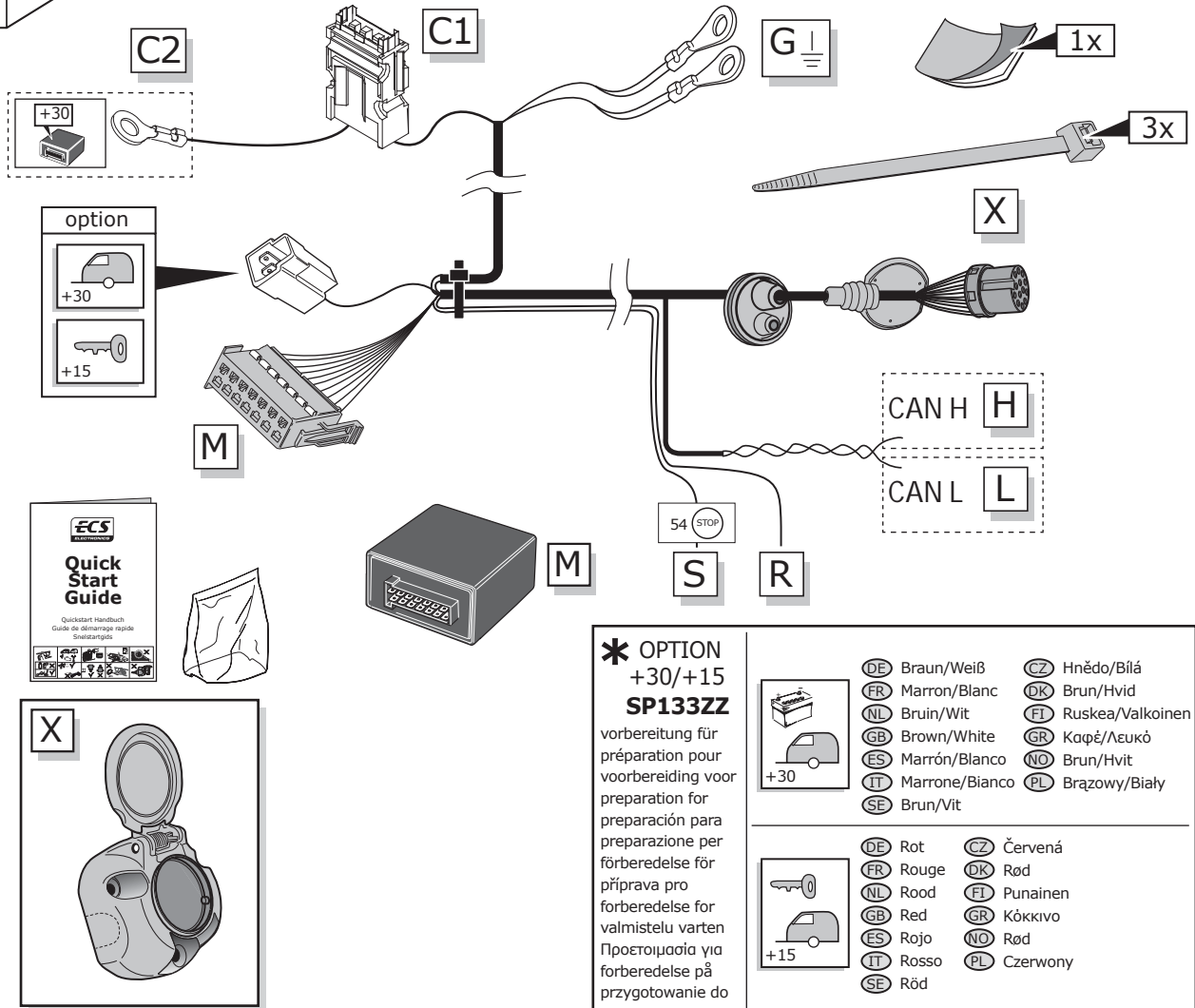
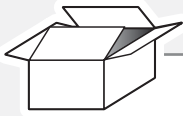

*** OPTION +30/+15 SP133ZZ**

vorbereitung für
préparation pour
voorbereiding voor
preparation for
preparación para
preparazione per
příprava pro
förberedelse för
příprava pro
forberedelse for
valmistelu varten
Προετοιμασία για
förberedelse på
przygotowanie do

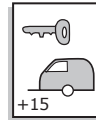
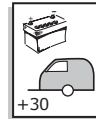

(DE) Braun/Weiß	(CZ) Hnědo/Bílá
(FR) Marron/Blanc	(DK) Brun/Hvid
(NL) Bruin/Wit	(FI) Ruskea/Valkoinen
(GB) Brown/White	(GR) Καφέ/Λευκό
(ES) Marrón/Blanco	(NO) Brun/Hvit
(IT) Marrone/Bianco	(PL) Brązowy/Biały
(SE) Brun/Vit	

(DE) Rot	(CZ) Červená
(FR) Rouge	(DK) Rød
(NL) Rood	(FI) Punainen
(GB) Red	(GR) Κόκκινο
(ES) Rojo	(NO) Rød
(IT) Rosso	(PL) Czerwony
(SE) Röd	

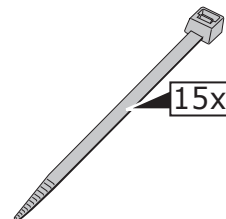
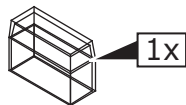
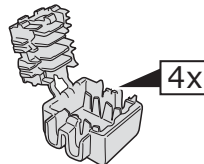
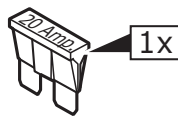
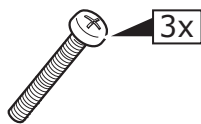

INFO



DO NOT CODE THE VEHICLE

INFO

- (DE) Fragen Sie erst den Händler, ob ein Erweiterungsset für Anhängerkupplung plus Wärmeisolation (wegen Kühlung) für Ihr Fahrzeug verfügbar ist.
- (FR) Renseignez-vous d'abord auprès du concessionnaire pour savoir si un kit d'extension pour crochet de remorquage avec isolation thermique (dans le cadre du refroidissement) s'applique à votre véhicule.
- (NL) Eerst informeren bij de dealer of een uitbreidingsset voor trekhaak plus warmteisolaties (ivm koeling) van toepassing is voor uw voertuig.
- (GB) First inquire at the dealer if an expansion set for a towing hook plus heat insulation (in connection with cooling) applies to your vehicle.
- (ES) Consulte al concesionario si al instalar enganche de remolque es necesario equipar su vehículo con un sistema de aislamiento térmico adicional (conectado al sistema de refrigeración).
- (IT) È necessario informarsi preventivamente presso il concessionario se è possibile applicare al veicolo un set supplementare per il gancio di trazione e gli isolamenti per il calore (in relazione al raffreddamento).
- (SE) Ska du först rådfråga din återförsäljare om extrautrustning med dragkrok plus värmeisolering (i anslutning till kylning) tillämpas för ditt fordon.
- (CZ) Se nejprve u prodejce dotazte, lze-li pro vaše vozidlo použít rozšiřující sadu s tažným hákem a tepelnou izolací (společně s chlazením).
- (DK) Skål du først spørge forhandleren, om der findes et udvidelsessæt med trækrog plus varmeisolering (i forbindelse med køling) til din bil.
- (FI) Kysy ensin jälleenmyyjältä, sopiiko ajoneuvoon laajennussarja, jossa on hinaus koukku ja lämpöeristys (jäähdytysjärjestelmässä).
- (GR) Ρωτήστε τον αντιπρόσωπο εάν εφαρμόζεται στο όχημά σας σετ εκτόνωσης με γάντζο ρυμούλκησης και θερμομόνωση (σε σχέση με την ψύξη).
- (NO) Må man høre med forhandleren om det finnes et sett med krok og varmeisolasjon (i tilfelle nedkjøling) som er tilpasset kjøretøyet.
- (PL) Najpierw należy dowiedzieć się u dealera, czy hak holowniczy z izolacją cieplną (połączoną z chłodzeniem) jest dostępny dla pojazdu.

INFO

	BK	BN	BU	GY	GN	WH	YE	OG	PE	PI	RD
(DE)	Schwarz	Braun	Blau	Grau	Grün	Weiß	Gelb	Orange	Violett	Rosa	Rot
(FR)	Noir	Marron	Blue	Gris	Vert	Blanc	Jaune	Orange	Violet	Rose	Rouge
(NL)	Zwart	Bruin	Blauw	Grijs	Groen	Wit	Geel	Oranje	Paars	Roze	Rood
(GB)	Black	Brown	Blue	Grey	Green	White	Yellow	Orange	Purple	Pink	Red
(ES)	Negro	Marrón	Azul	Gris	Verde	Blanco	Amarillo	Naranja	Morado	Rosa	Rojo
(IT)	Nero	Marrone	Blu	Grigio	Verde	Bianco	Giallo	Arancione	Viola	Rosa	Rosso
(SE)	Svart	Brun	Blå	Grå	Grön	Vit	Gul	Orange	Lila	Rosa	Röd
(CZ)	Černá	Hnědá	Modrá	Šedá	Zelená	Bílá	Žlutá	Oranžová	Fialová	Růžová	Červená
(DK)	Sort	Brun	Blå	Grå	Grøn	Hvid	Gul	Orange	Lilla	Pink	Rød
(FI)	Musta	Ruskea	Sininen	Harmaa	Vihreä	Valkoinen	Keltainen	Oranssi	Purppura	Vaaleanpunainen	Punainen
(GR)	Μαύρο	Καφέ	Μπλε	Γκρι	Πράσινο	Λευκό	Κίτρινο	Πορτοκαλί	Μοβ	Ροζ	Κόκκινο
(NO)	Svart	Brun	Blå	Grå	Grønn	Hvit	Gul	Oransje	Lilla	Rosa	Rød
(PL)	Czarny	Brązowy	Niebieski	Szary	Zielony	Biały	Żółty	Pomarańczowy	Purpurowy	Różowy	Czerwony

INFO

BMW 5 Serie E60

**Pag. 4 - Pag. 10
+
Pag. 16 -Pag. 22**

BMW 5 Serie E61

Pag. 11 - Pag. 22

BMW 5 Series E60

ROUTING

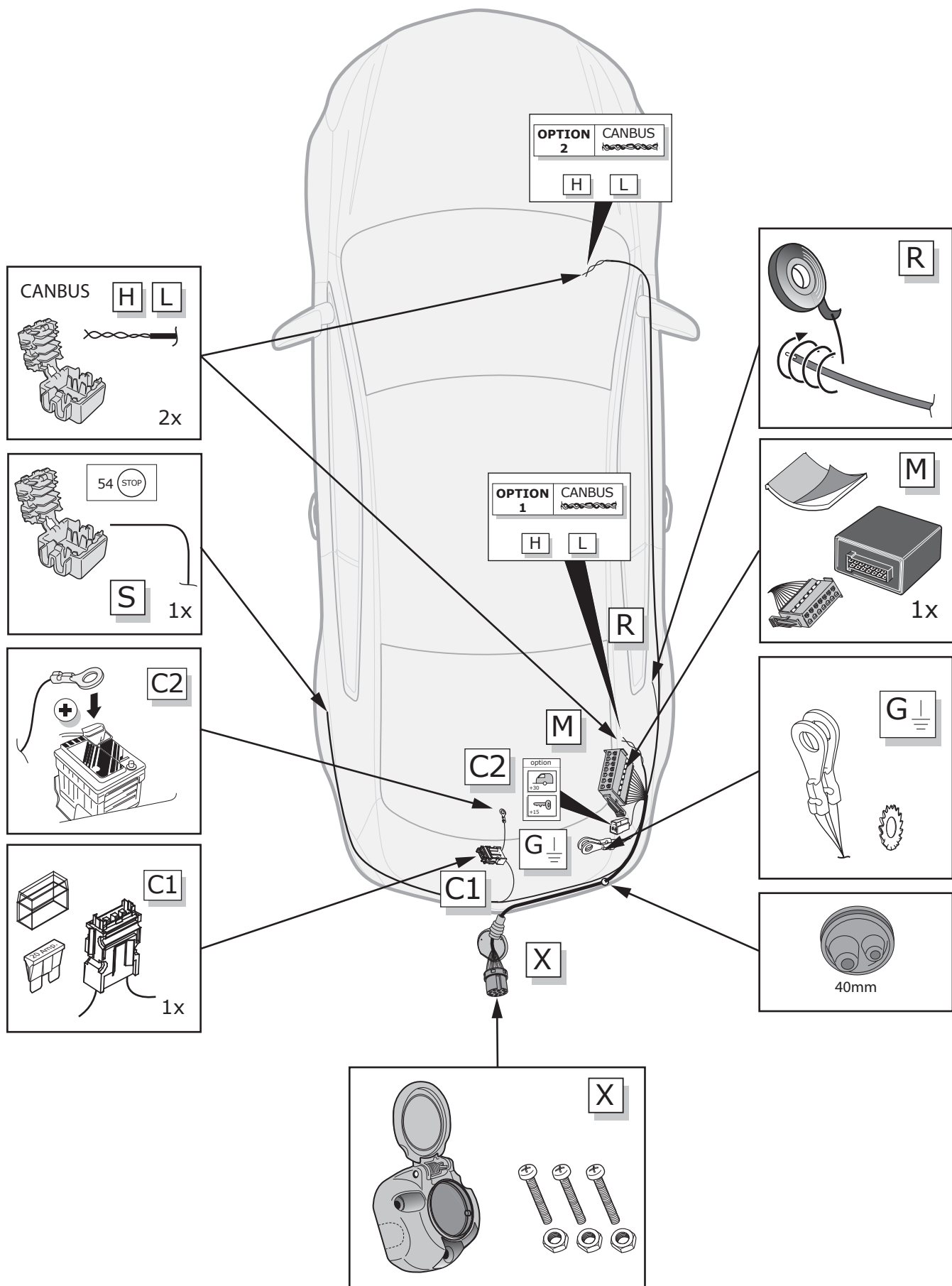

1

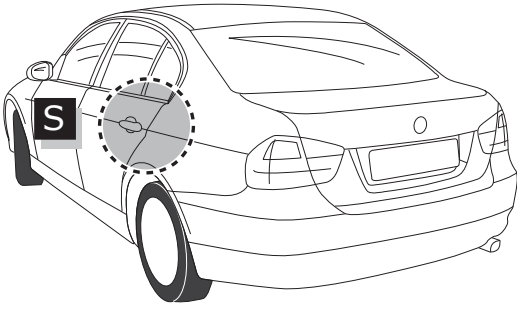
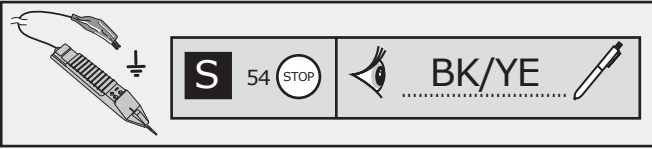

2

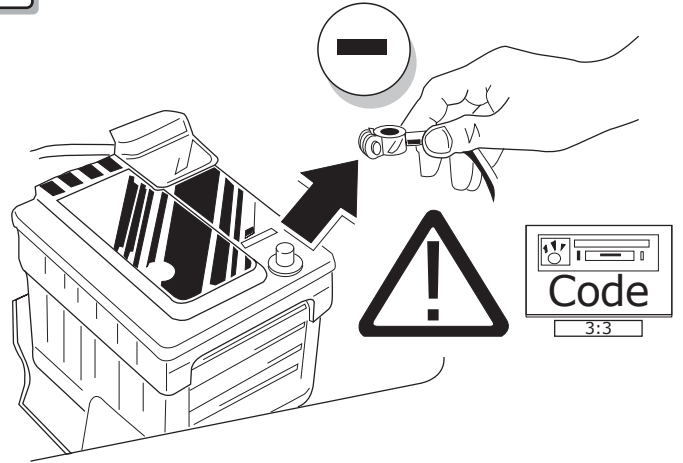

3

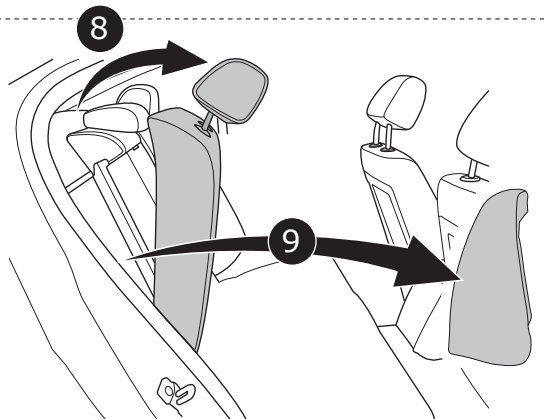
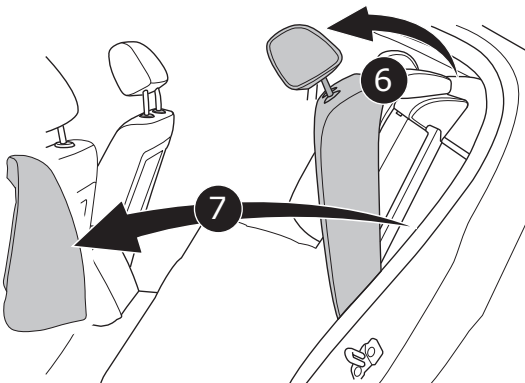
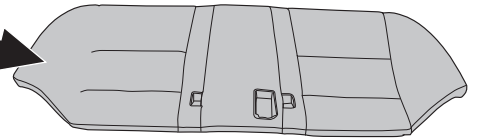
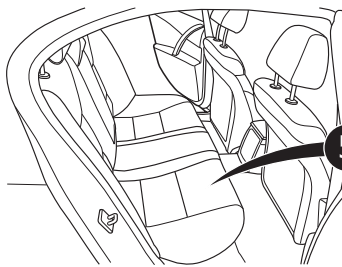
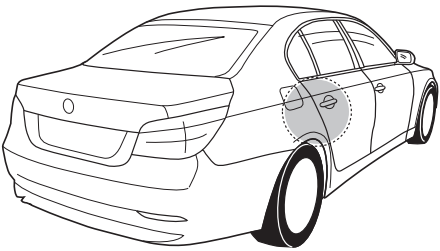
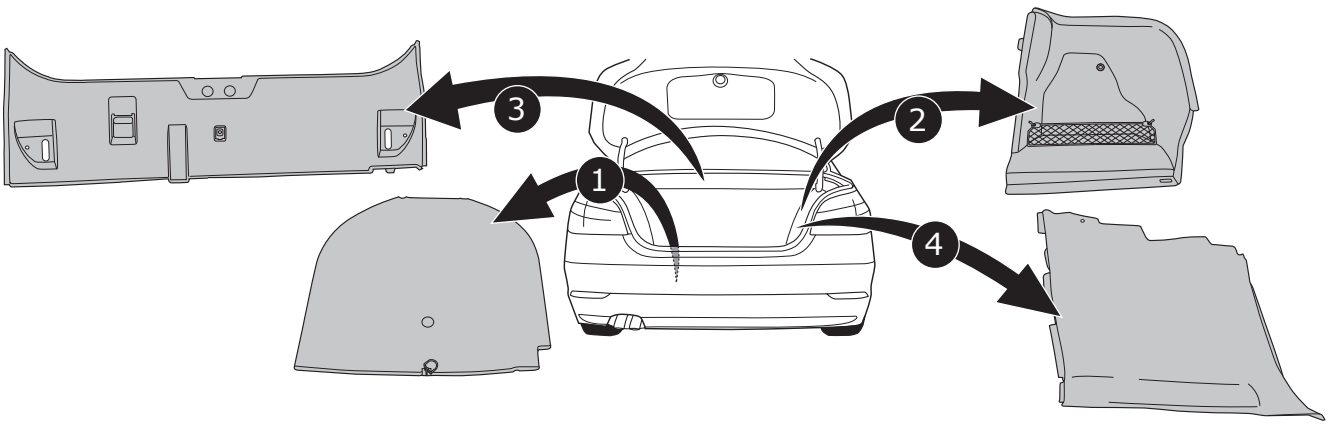

4

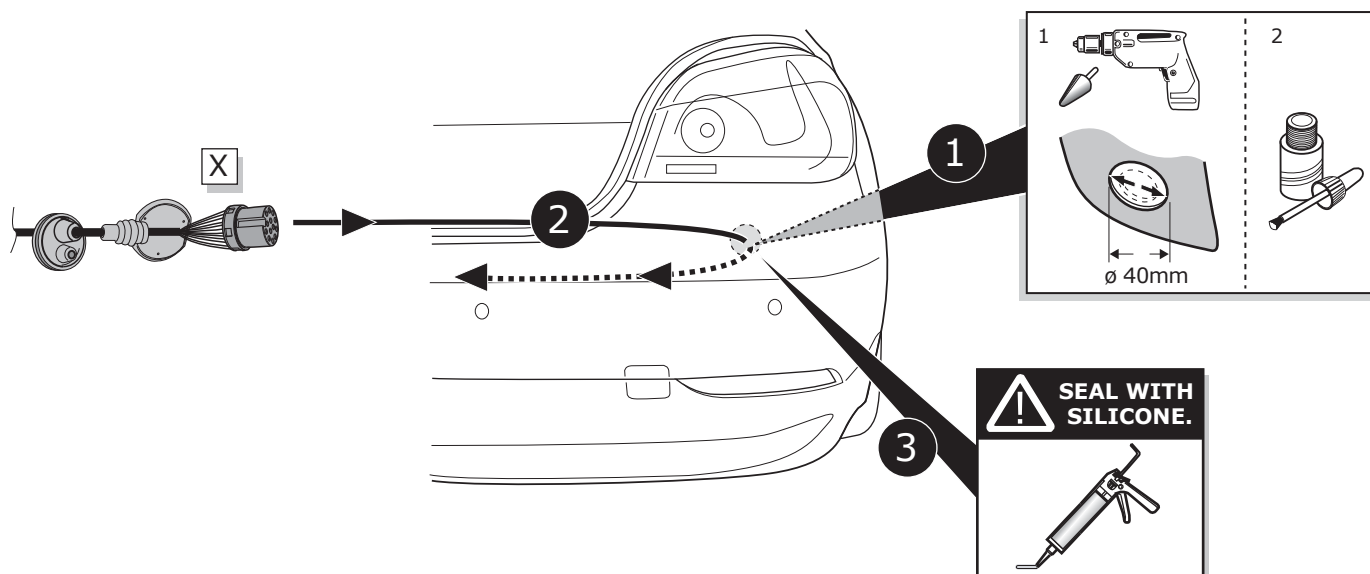

5

- | | |
|-------------------------------------|-------------------------------|
| (DE) Anschluss Steckdose | (SE) Anslutning kontaktdosa |
| (FR) Connection de la prise | (CZ) Objímkový konektor |
| (NL) Contactdoos aansluiting | (DK) Stikdåse forbindelse |
| (GB) Socket connection | (FI) Pistorasia liitäntä |
| (ES) Conexión de la caja de enchufe | (GR) Υποδοχή σύνδεσης |
| (IT) Allaccio zoccolo | (NO) Tilkobling koblingsboks |
| | (PL) Połączenie przez gniazdo |



Pag. 20 - 21

6

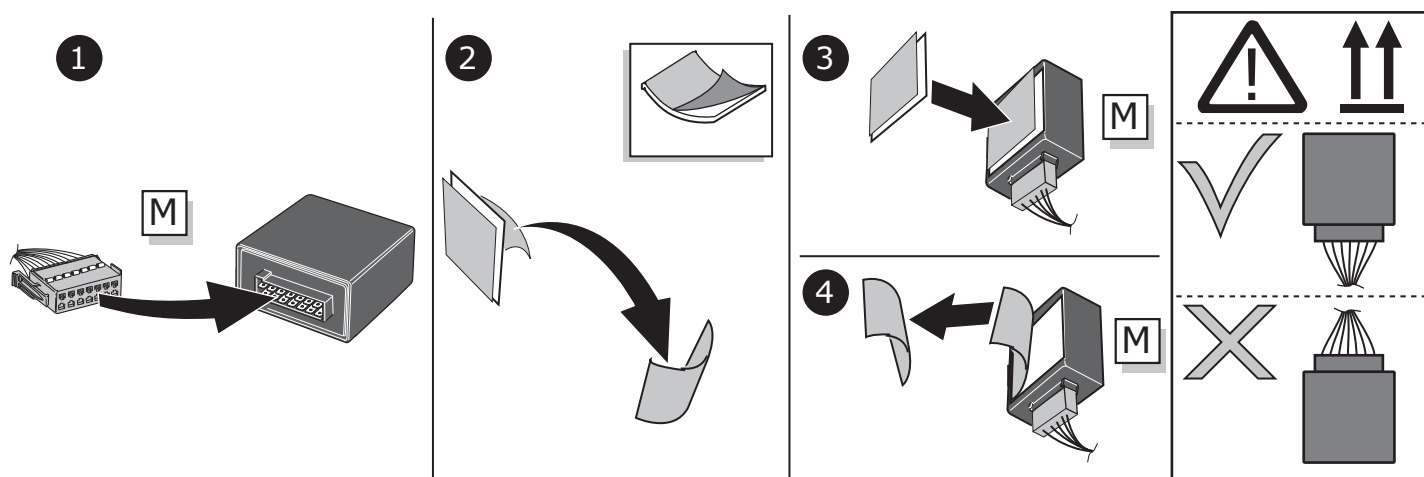

7

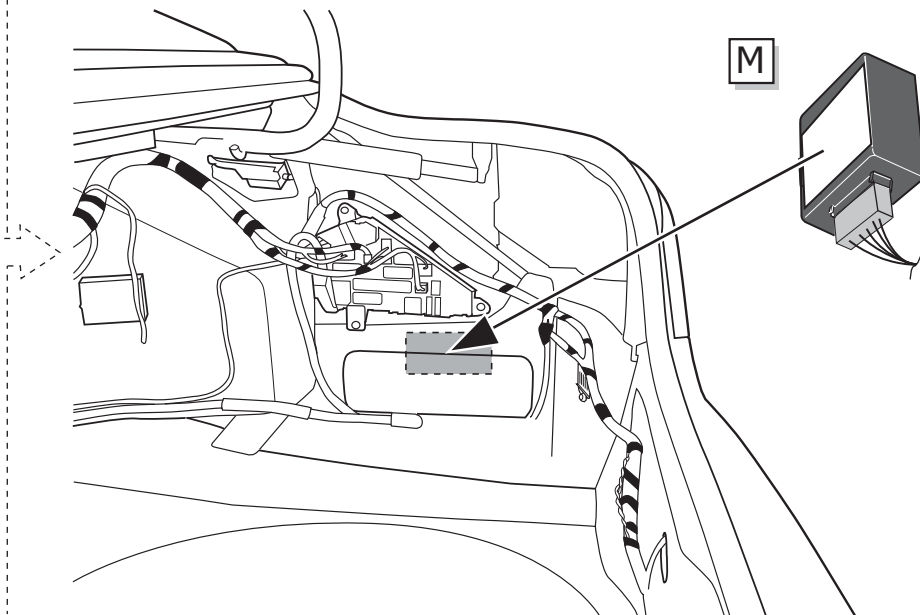
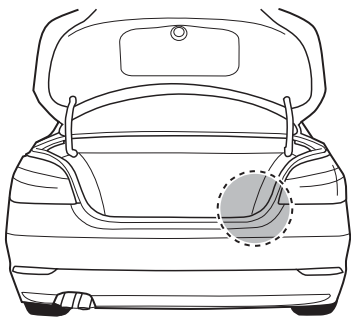

8

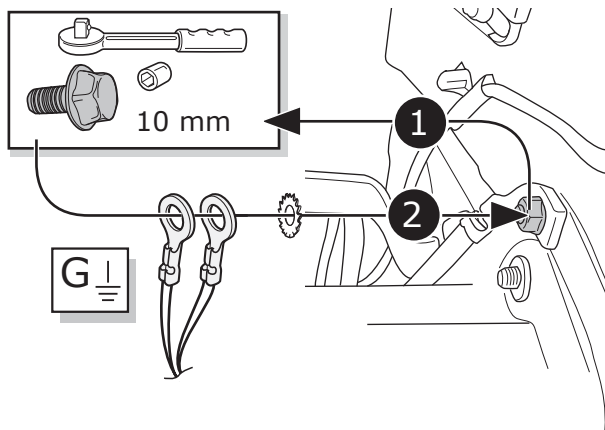
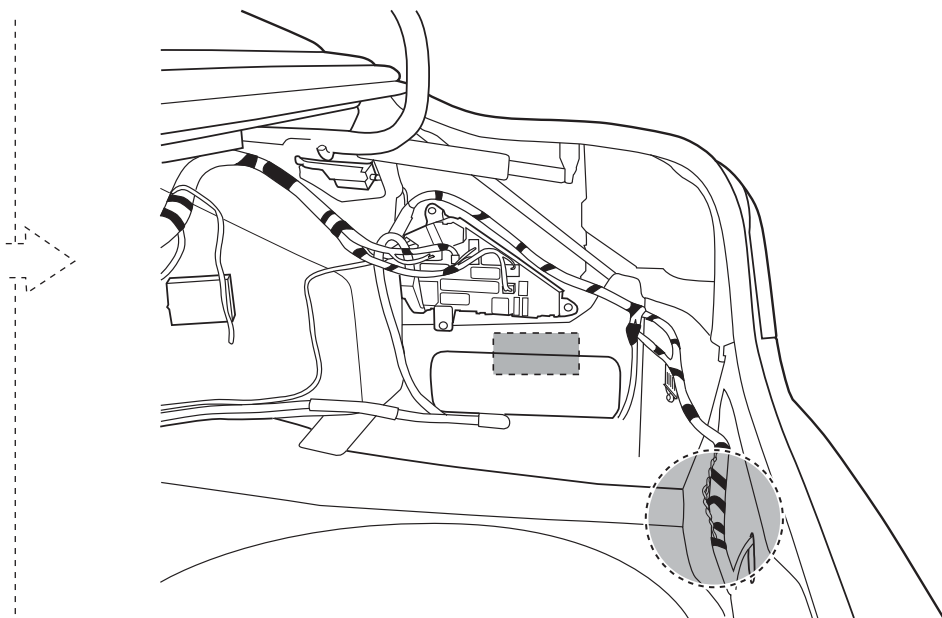
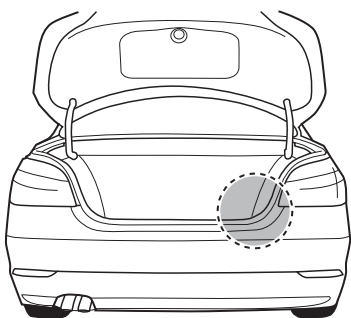

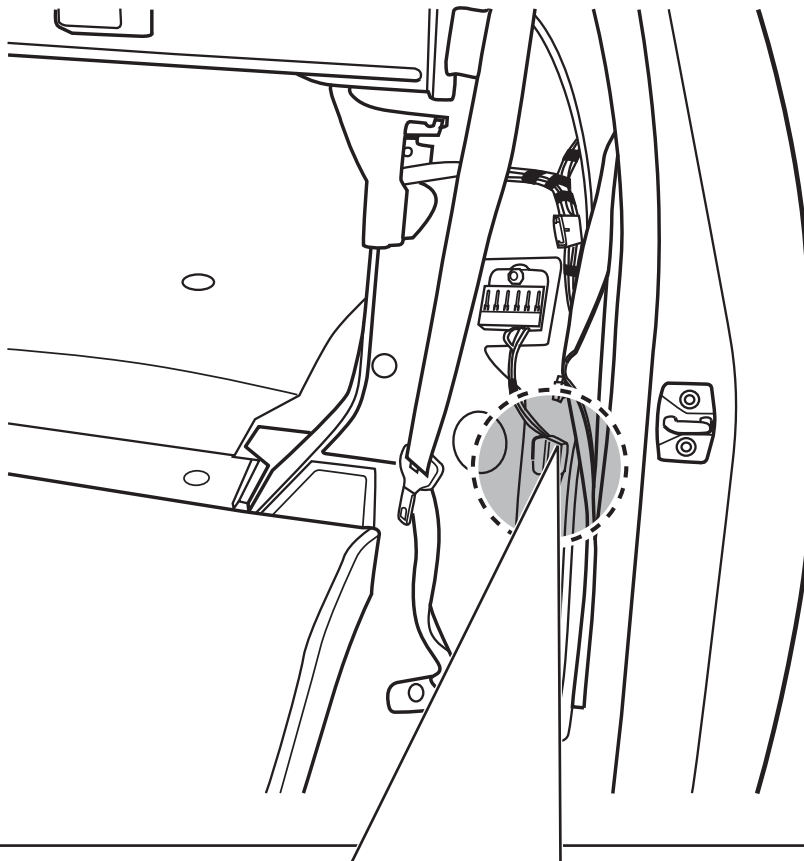
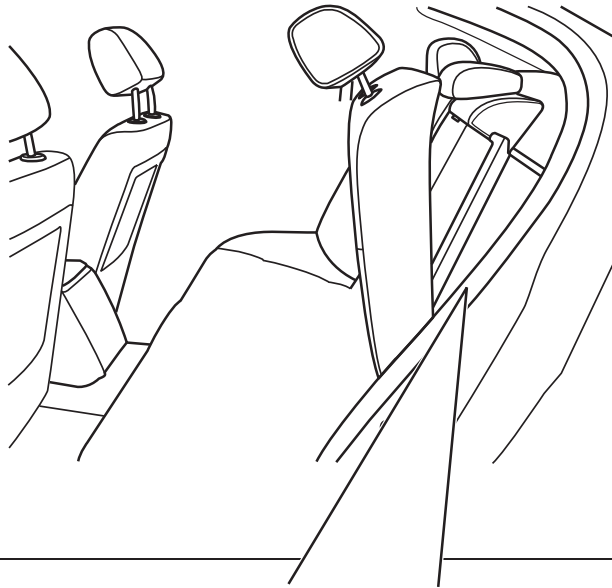
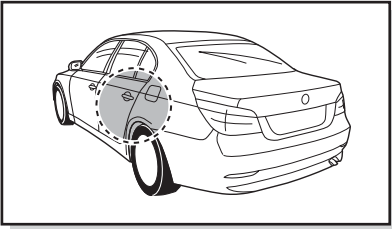

54 STOP

INFO

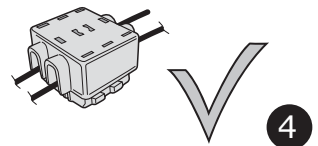
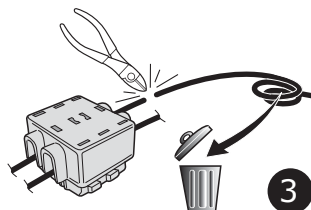
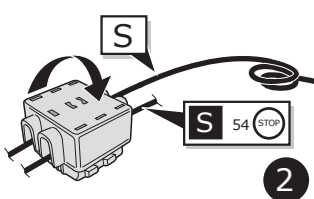
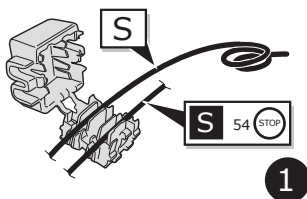

Option 1

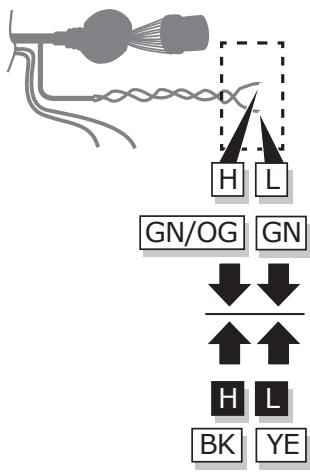
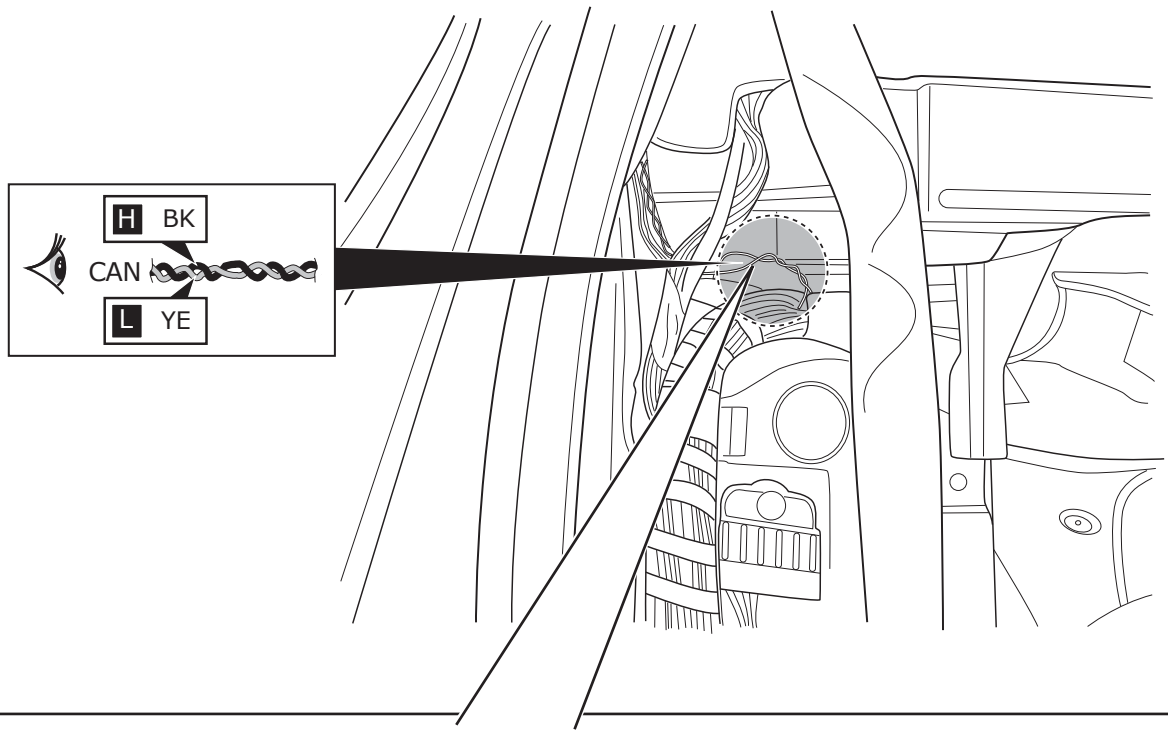
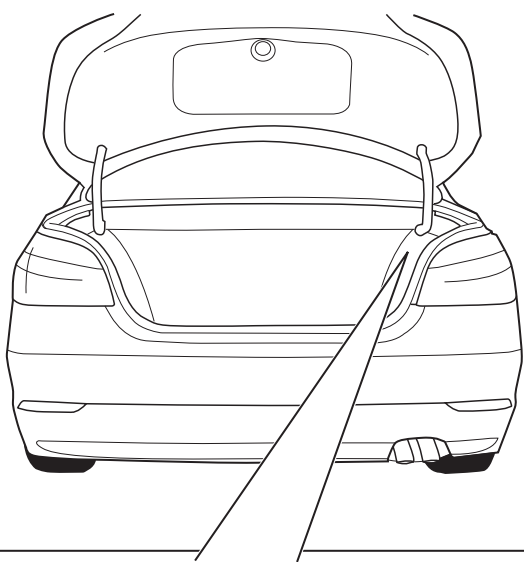
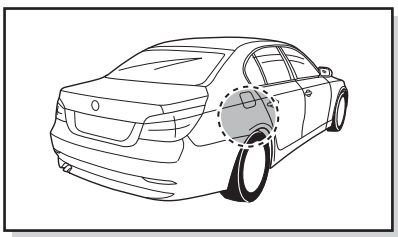

INFO

INFO

Pag. 3

DE Farben	CZ Barevným
FR Couleurs	SK Farverne
NL Kleuren	PT Coloria
GB Colours	GR χρώματα
ES Colores	NO Farger
IT Colori	PL Kolorowac
SE Färgar	

Option 2

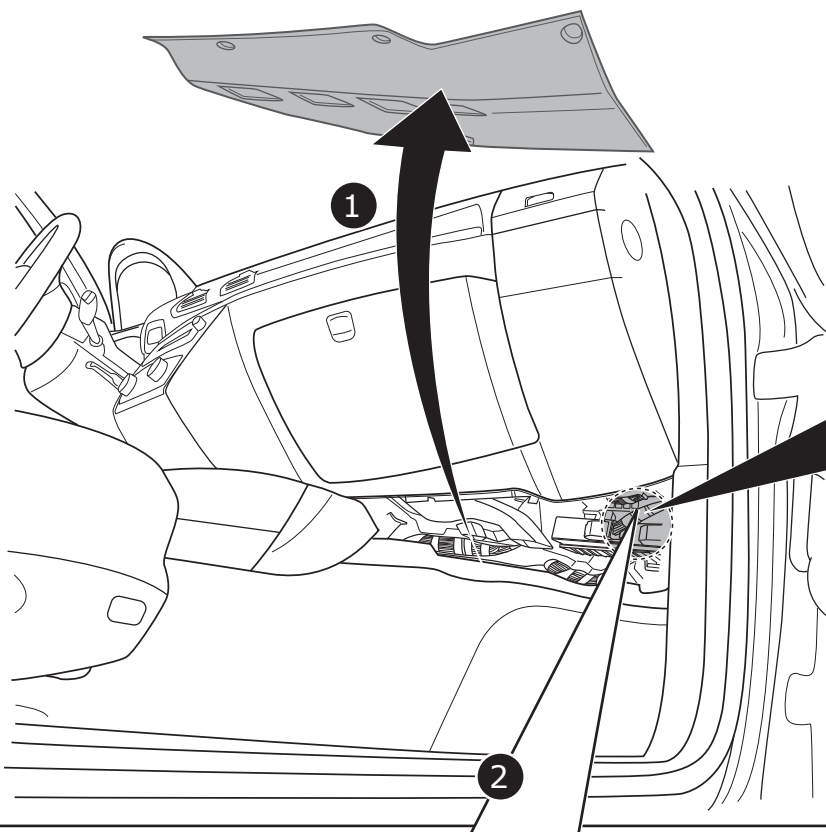
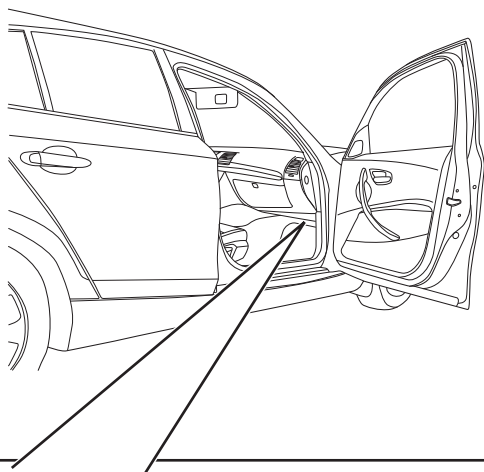
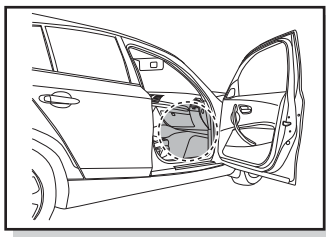

CANBUS

H	BK
L	YE

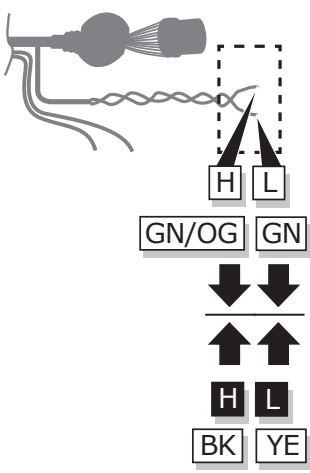

<p>H GN/OG</p> <p>L BK</p>	<p>L GN</p> <p>L YE</p>
<p>H GN/OG</p> <p>L BK</p>	<p>L GN</p> <p>L YE</p>

INFO

INFO

Pag. 3

DE Farben	CZ Barevným
FR Couleurs	DK Farverne
NL Kleuren	EL Coloria
ES Colours	SK χρώματα
IT Colores	NO Farger
PL Färger	PL Kolorowac

BMW 5 Series E61

ROUTING

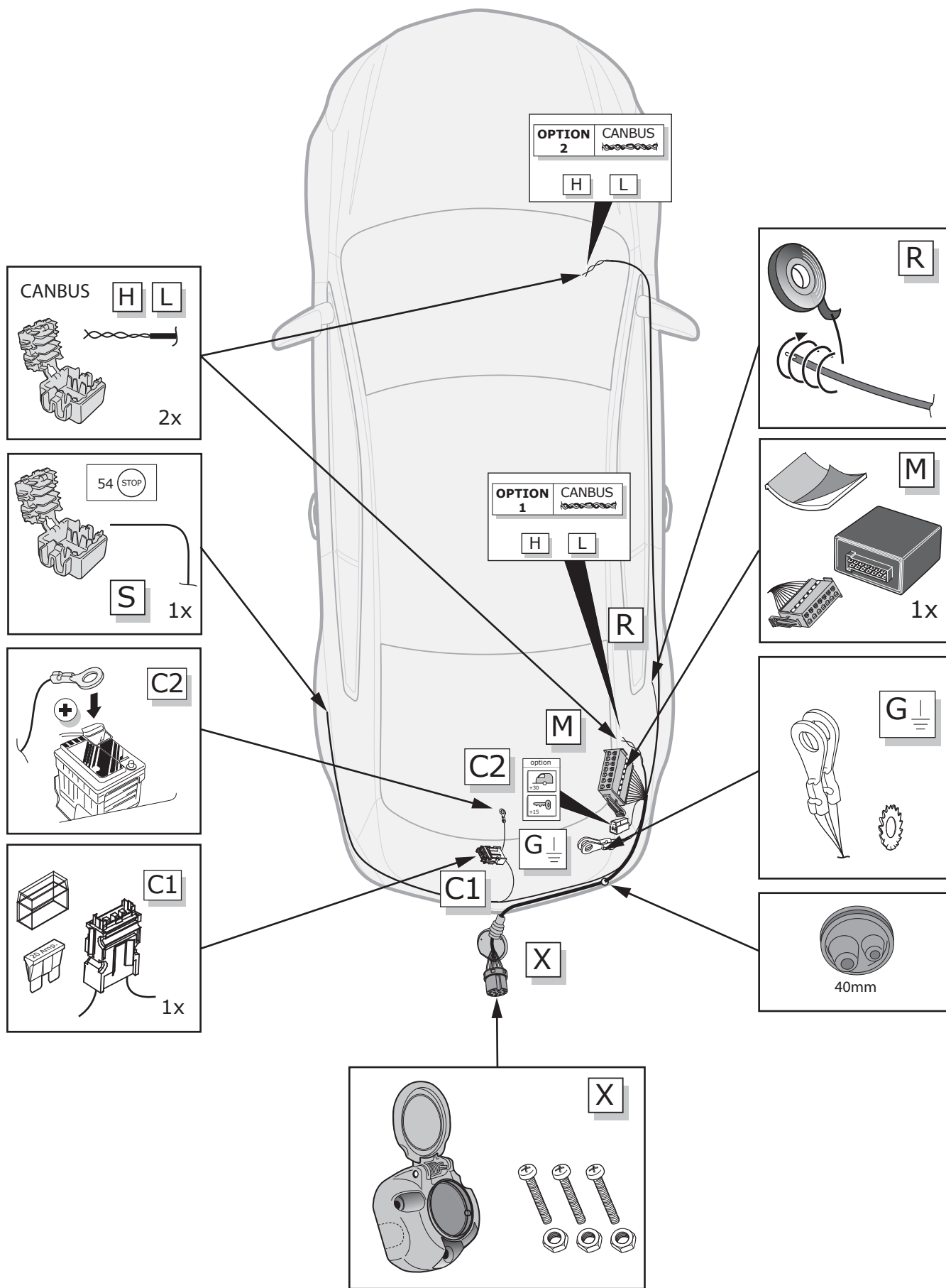

1

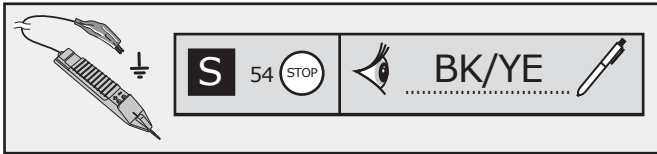

S

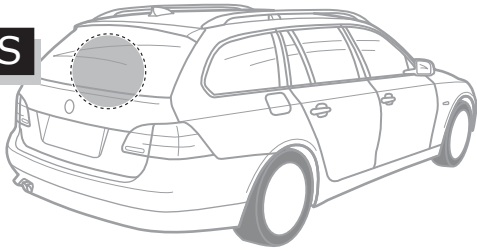

2

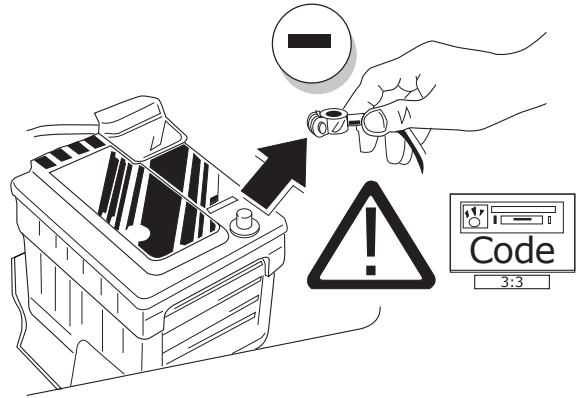

3

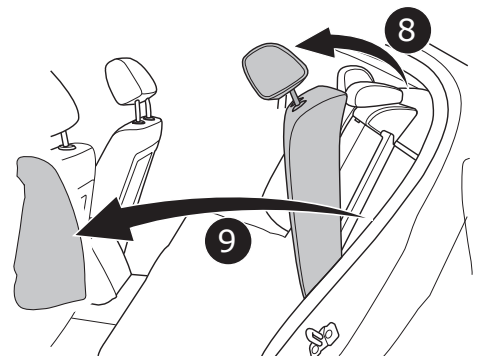
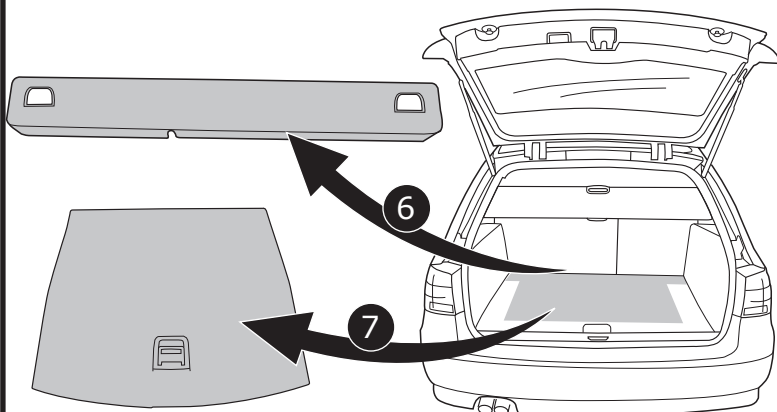
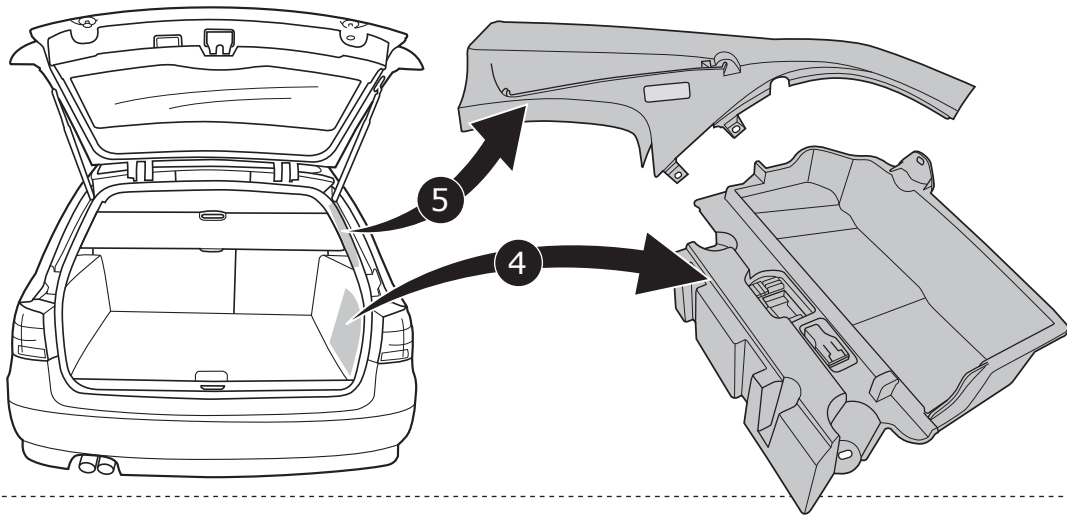
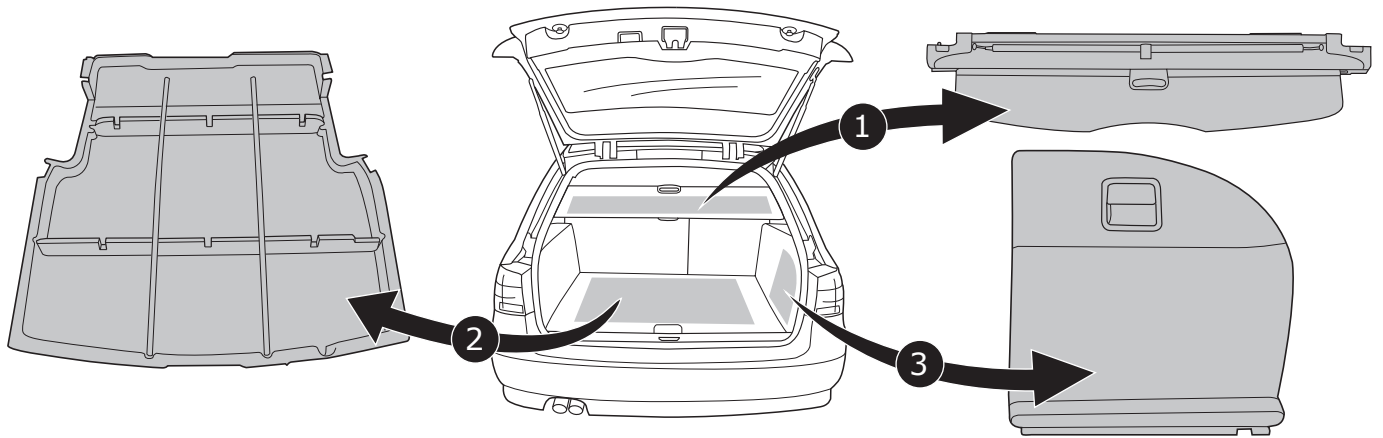

4

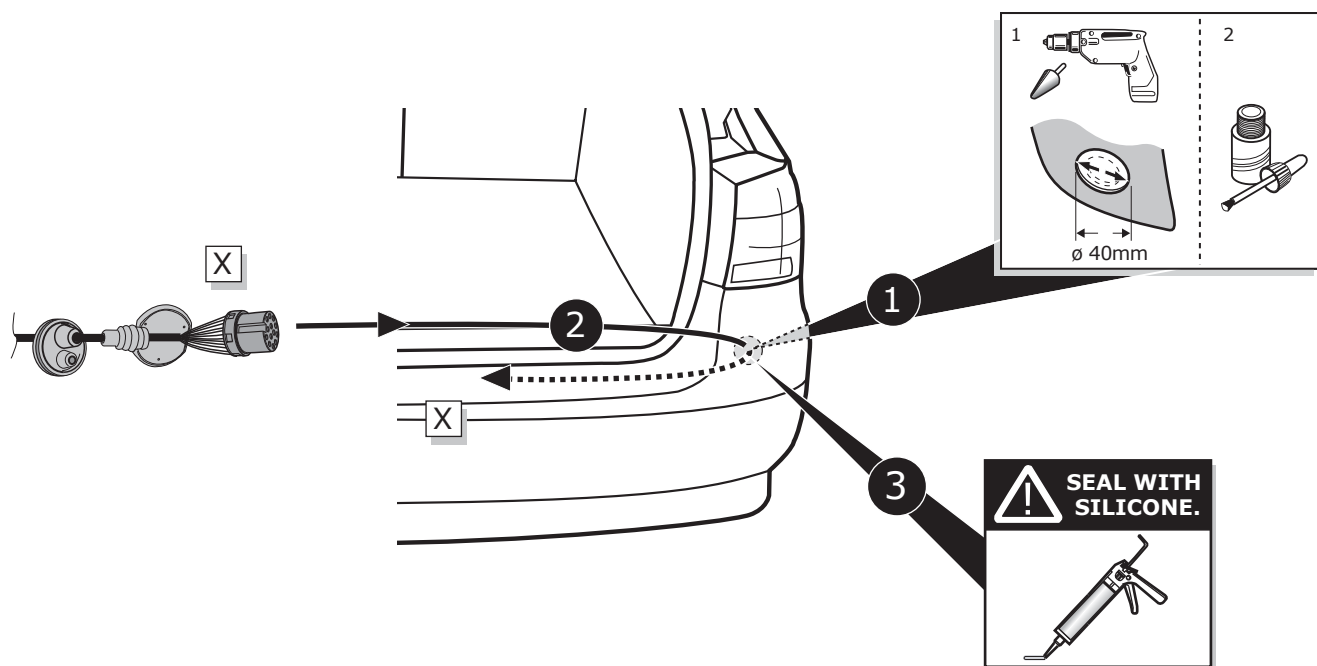

5

- | | |
|-------------------------------------|-------------------------------|
| (DE) Anschluss Steckdose | (SE) Anslutning kontaktdosa |
| (FR) Connection de la prise | (CZ) Objímkový konektor |
| (NL) Contactdoos aansluiting | (DK) Stikdåse forbindelse |
| (GB) Socket connection | (FI) Pistorasia liitäntä |
| (ES) Conexión de la caja de enchufe | (GR) Υποδοχή σύνδεσης |
| (IT) Allaccio zoccolo | (NO) Tilkobling koblingsboks |
| | (PL) Połączenie przez gniazdo |



Pag. 20 - 21

6

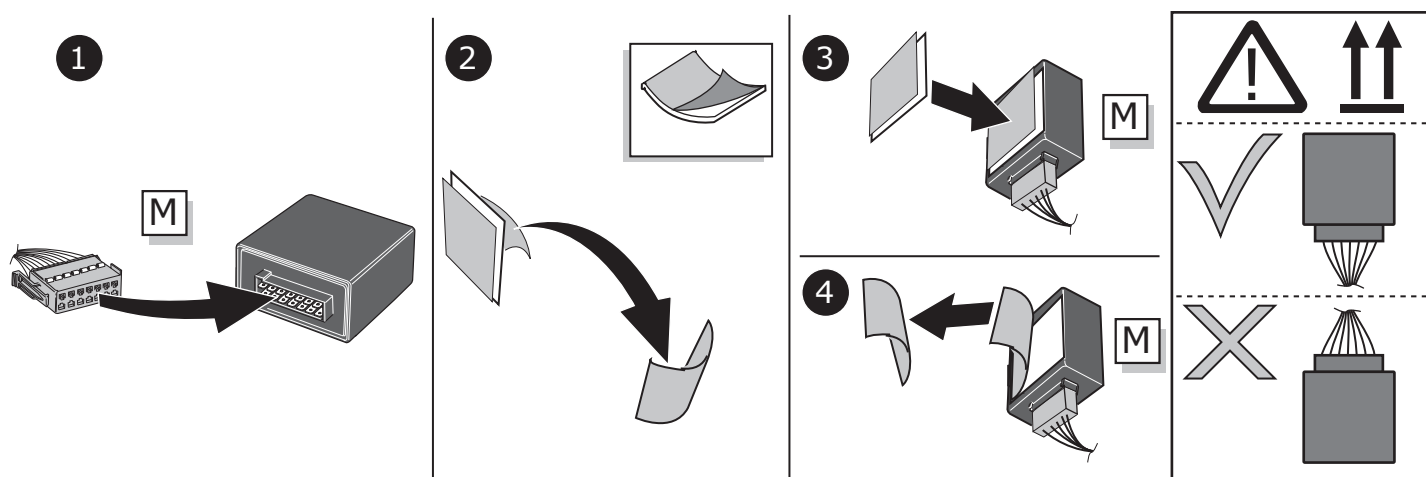

7

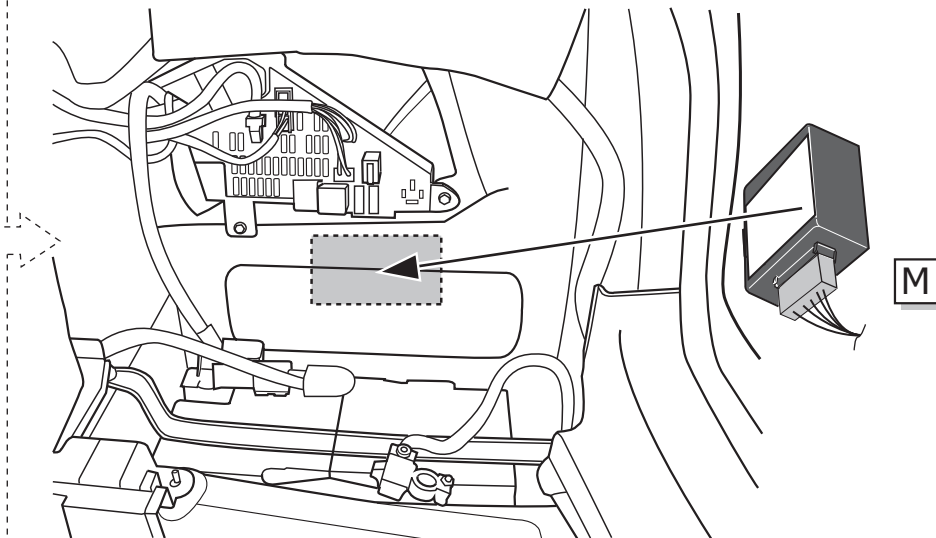
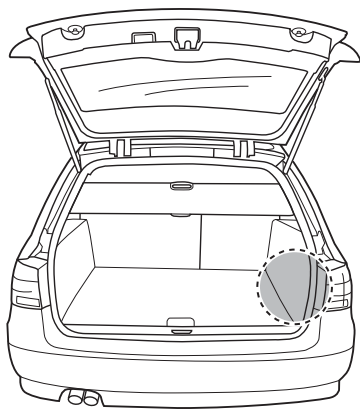

8

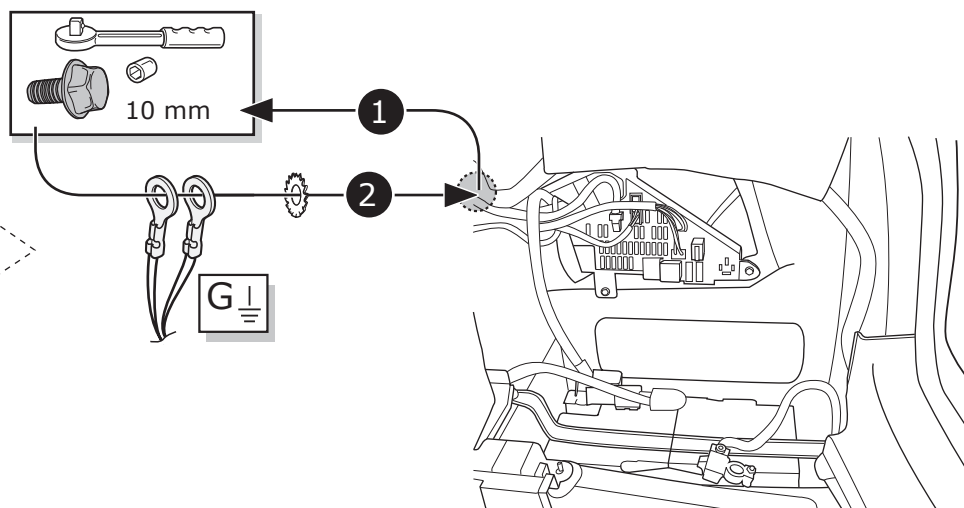
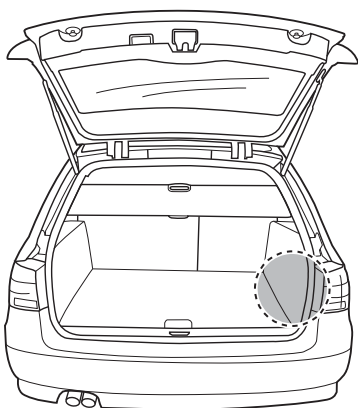

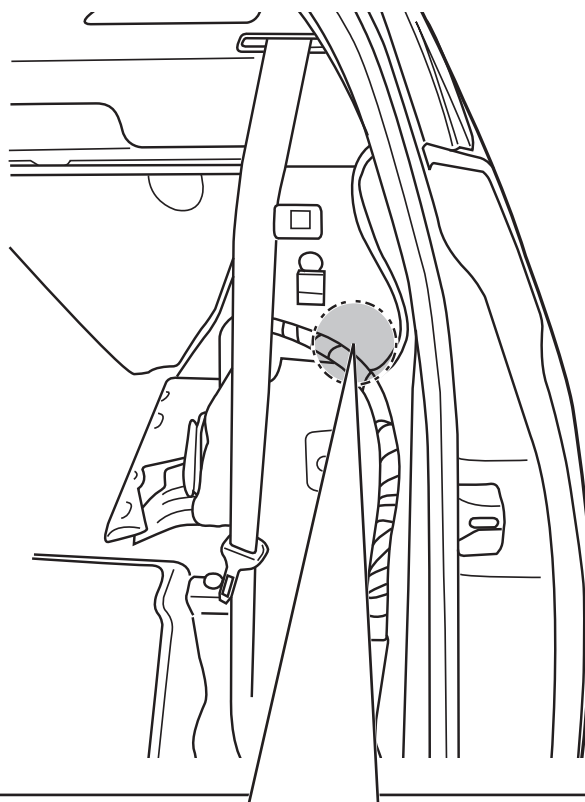
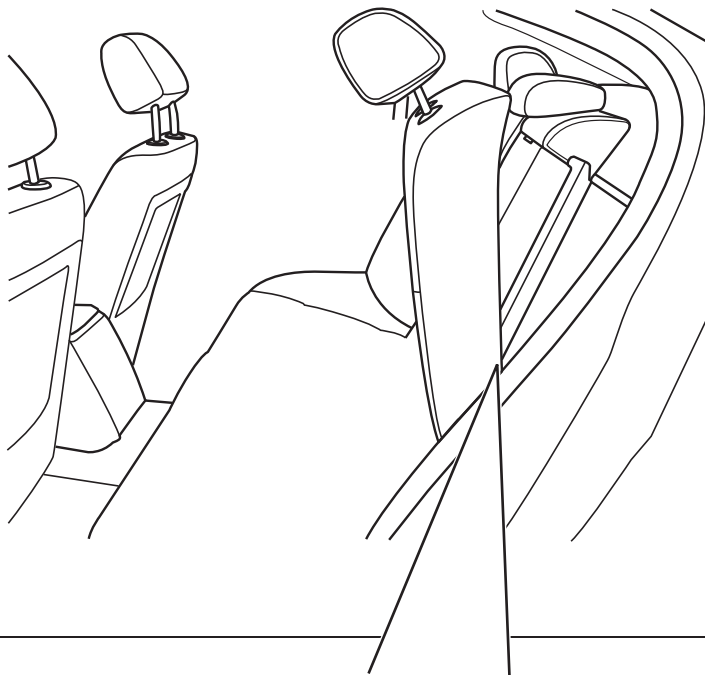
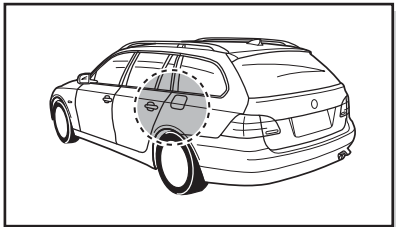

54 STOP

INFO



Pag. 12

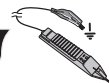

54 STOP

BK/YE

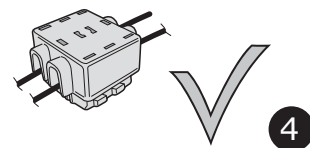
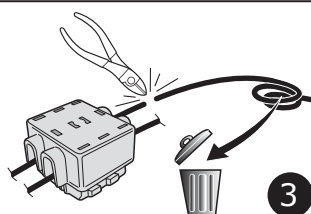
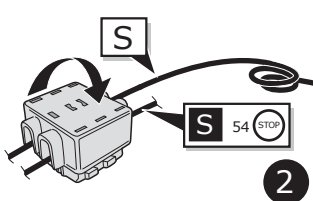
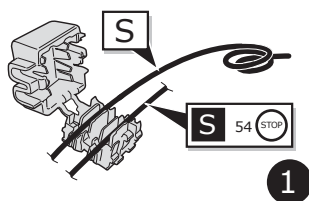

Option 1

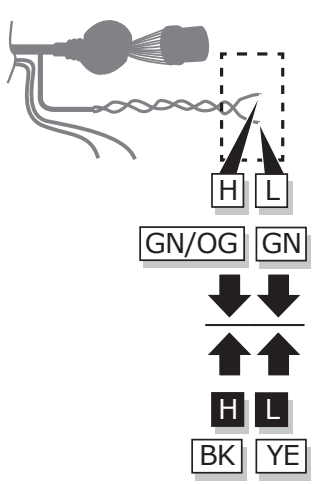
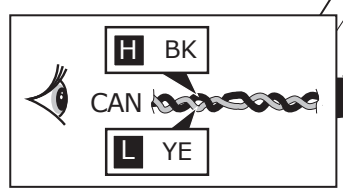
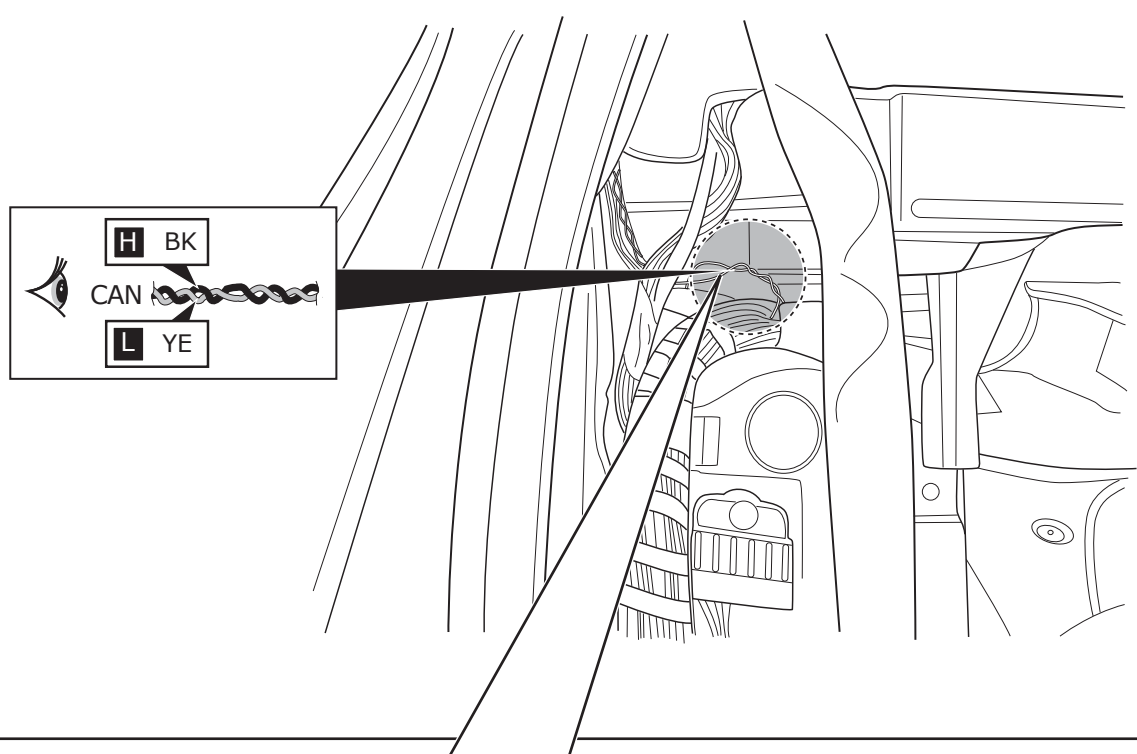
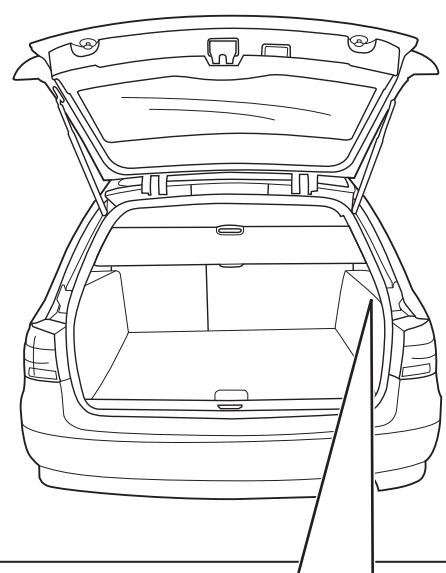
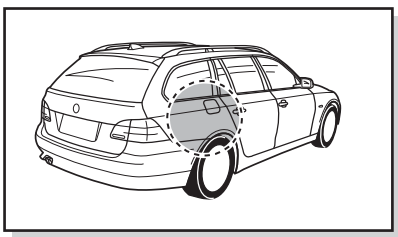

INFO

INFO

Pag. 3

DE Farben	CZ Barevným
FR Couleurs	SK Farverne
NL Kleuren	PT Coloria
GB Colours	GR χρώματα
ES Colores	NO Farger
IT Colori	PL Kolorowac
SE Färgar	

Option 2

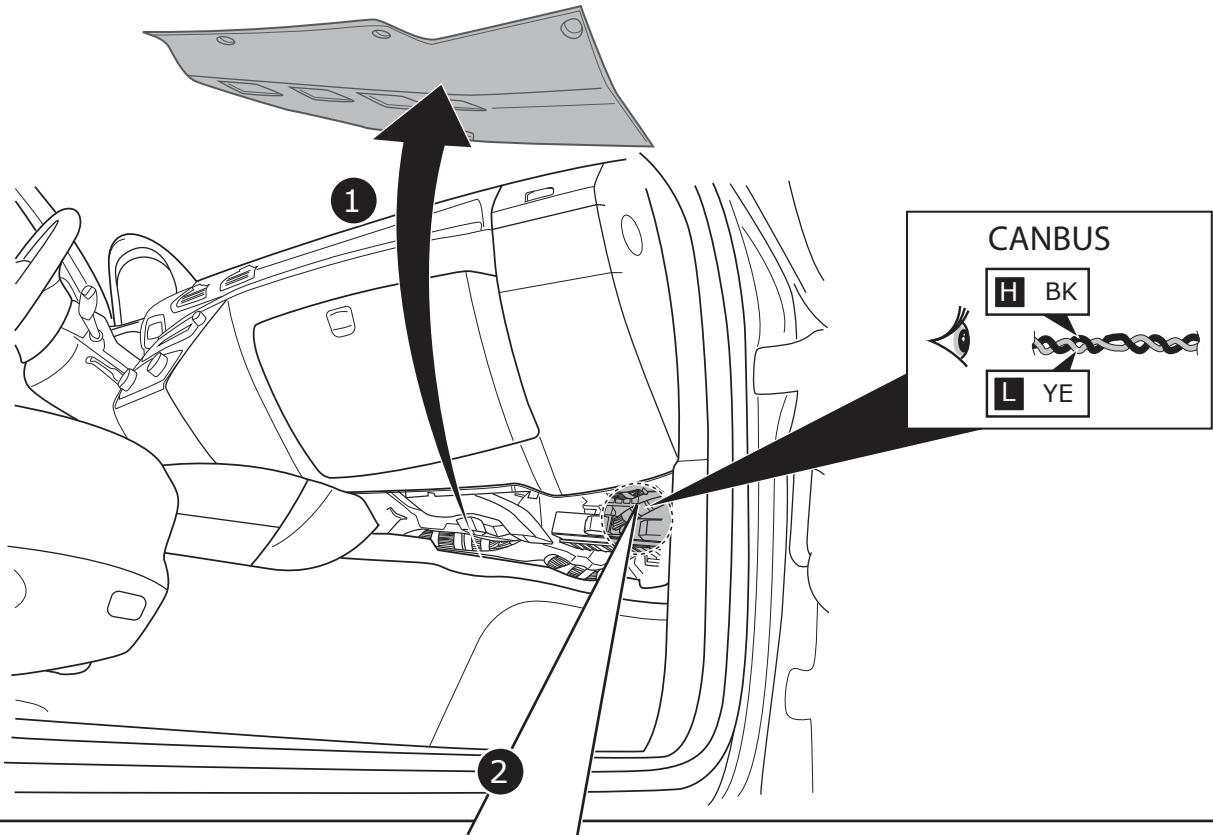
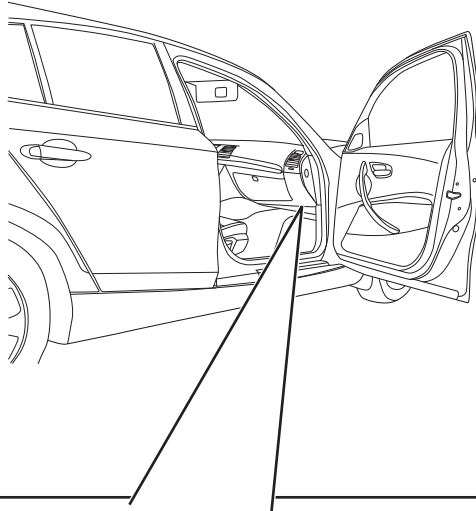
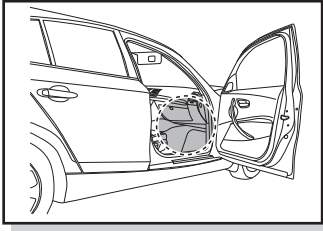

CANBUS

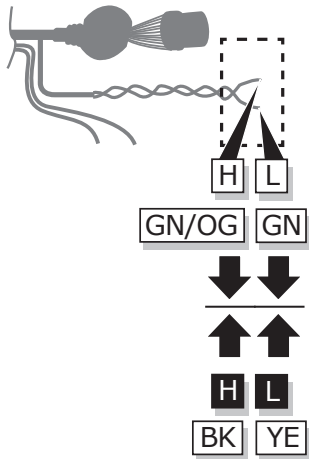

<p>INFO</p>		

INFO



Pag. 3

- | | |
|-------------|--------------|
| DE Farben | CZ Barevným |
| FR Couleurs | DK Farverne |
| NL Kleuren | IT Coloria |
| GB Colours | GR χρώματα |
| ES Colores | NO Farger |
| IT Colori | PL Kolorowac |
| SE Färgar | |

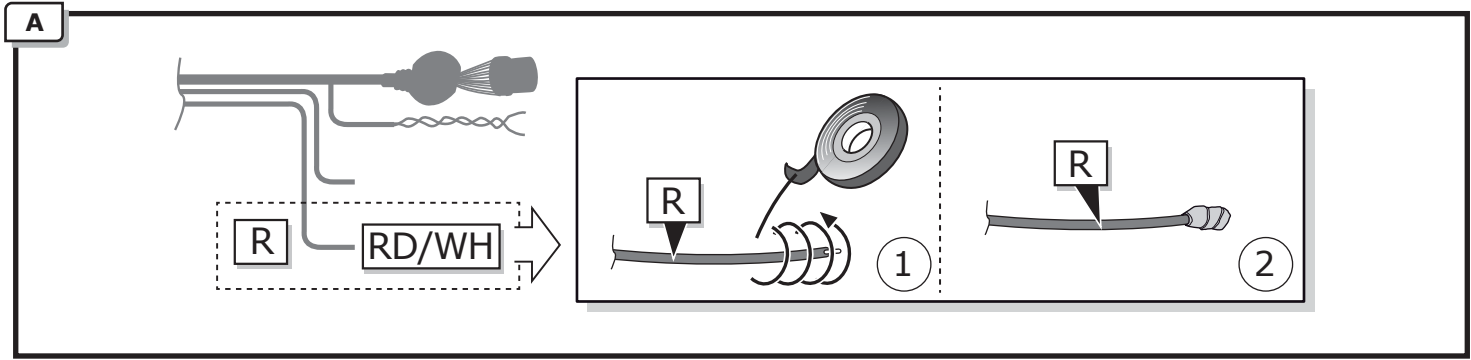

B

INFO

Pag. 3

DE Farben	CZ Barevným
FR Couleurs	DK Farverne
NL Kleuren	EL Coloria
ES Colours	GR χρώματα
CS Colores	NO Farger
IT Colori	PL Kolorowac
SE Färgar	

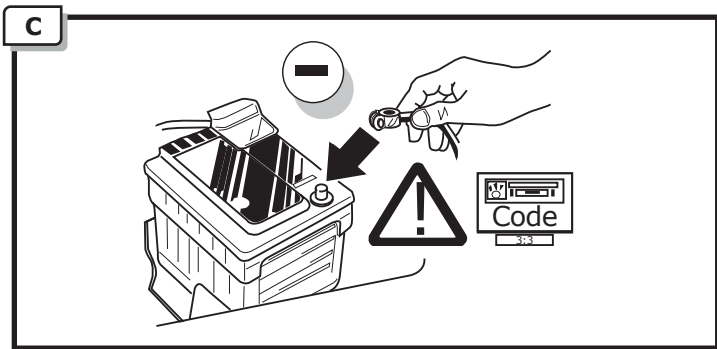

D

DO NOT CODE THE VEHICLE

E

Functional test

WARNING

LIGHTMATE®

ECS part no.
LIGHTMATE II
LIGHTMATE III

Products & Service: <https://www.ecs-electronics.nl/test-equipment>

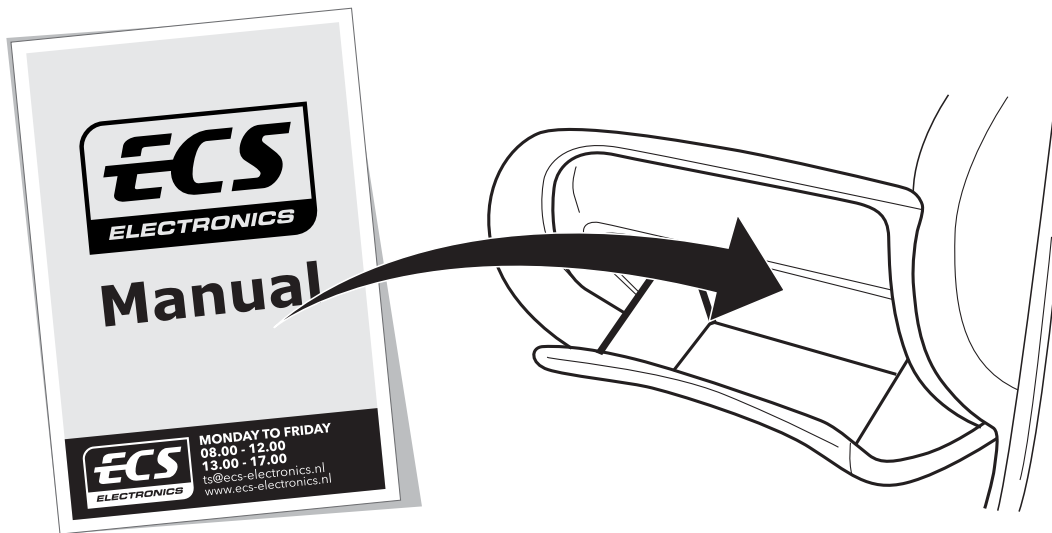
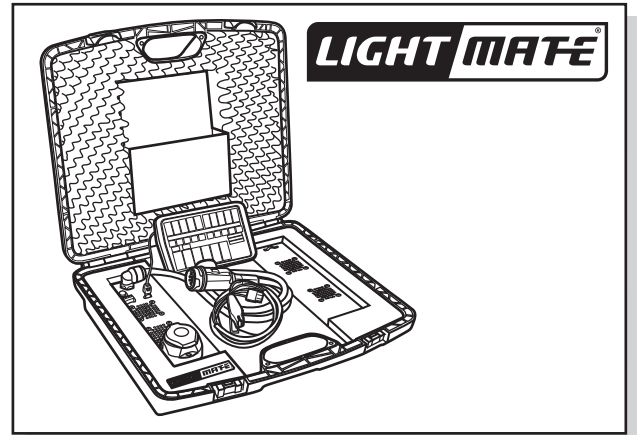
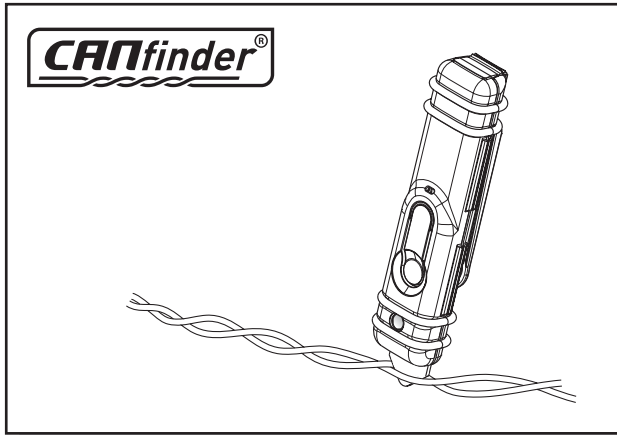

**FITTERS
TECHNICAL
SUPPORT**



**MONDAY TO FRIDAY
08.00 - 12.00
13.00 - 17.00**

ts@ecs-electronics.nl
www.ecs-electronics.nl
tel: +31 (0)76 573 0020

INFO SOCKET CONNECTION

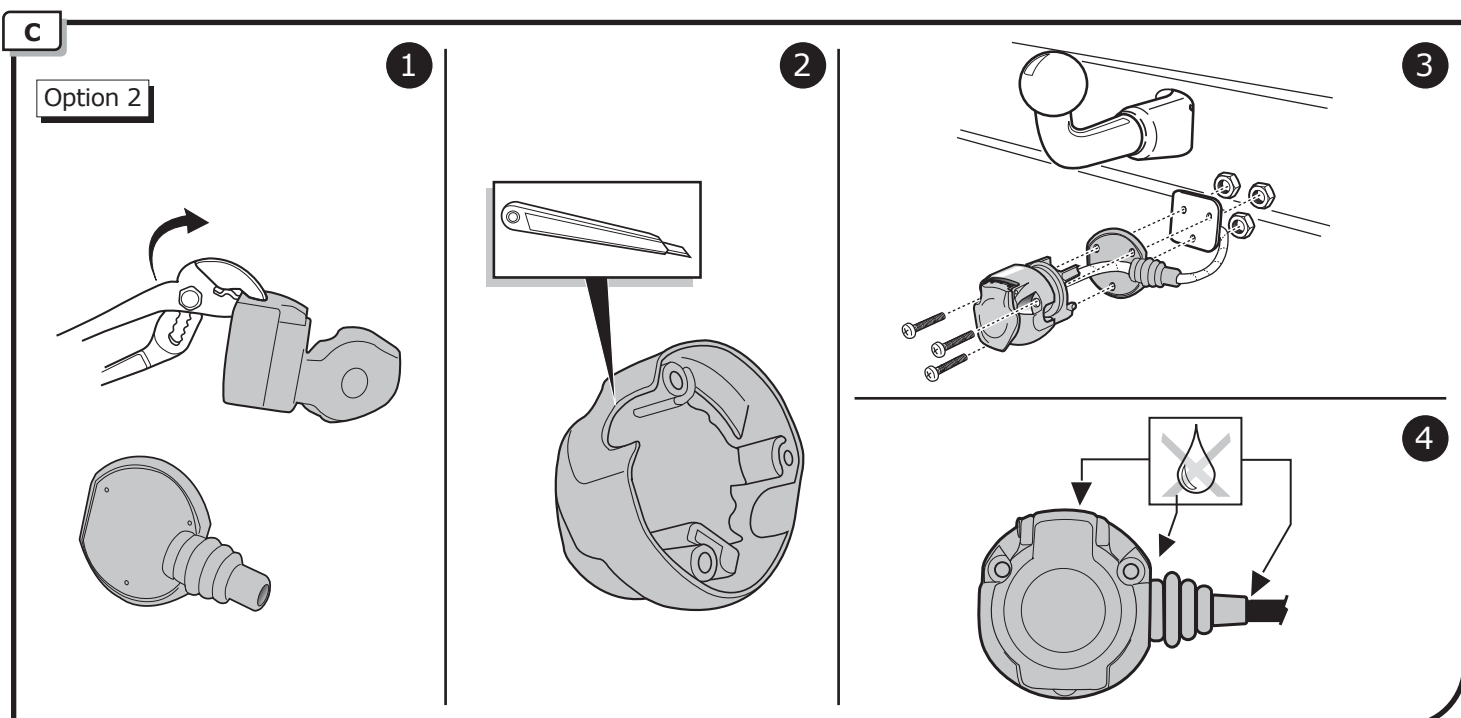
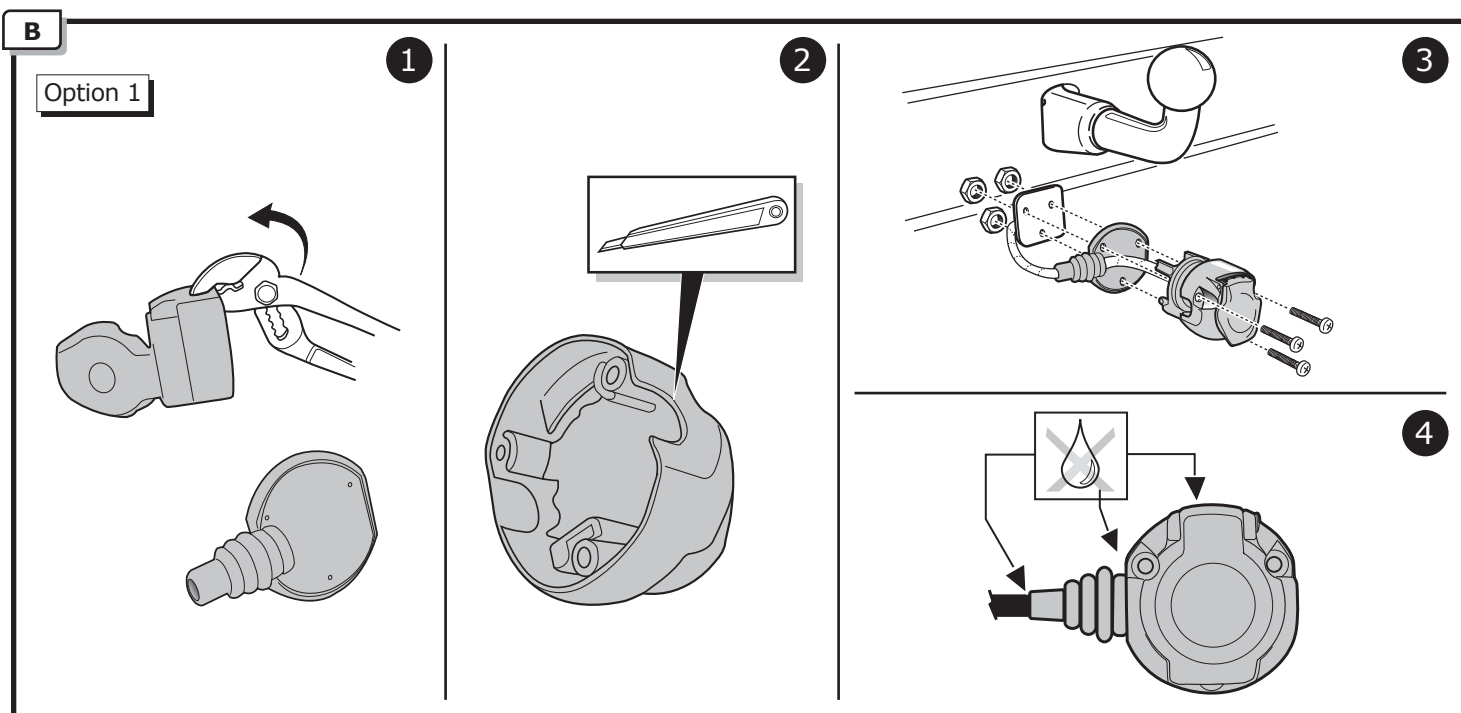
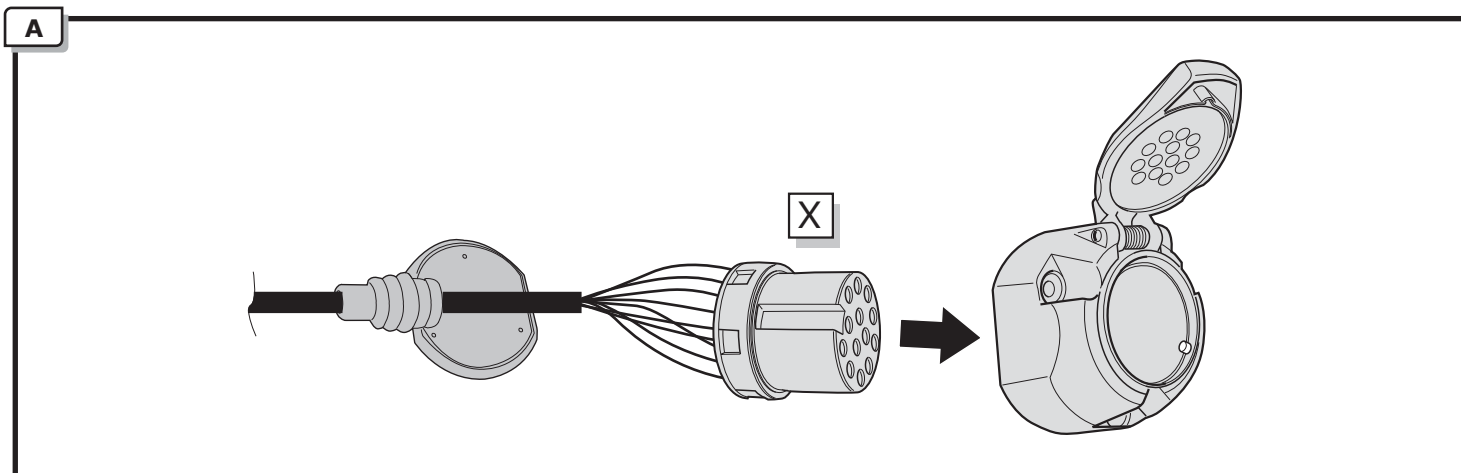

INFO

- (DE) Anschluss Steckdose (ES) Conexión de la caja de enchufe (CZ) Objímkový konektor (GR) Υποδοχή σύνδεσης
- (FR) Connection de la prise (IT) Allaccio zoccolo (DK) Stikdåse forbindelse (NO) Tilkobling koblingsboks
- (NL) Contactdoos aansluiting (SE) Anslutning kontaktdosa (FI) Pistorasia liitäntä (PL) Połączenie przez gniazdo
- (GB) Socket connection

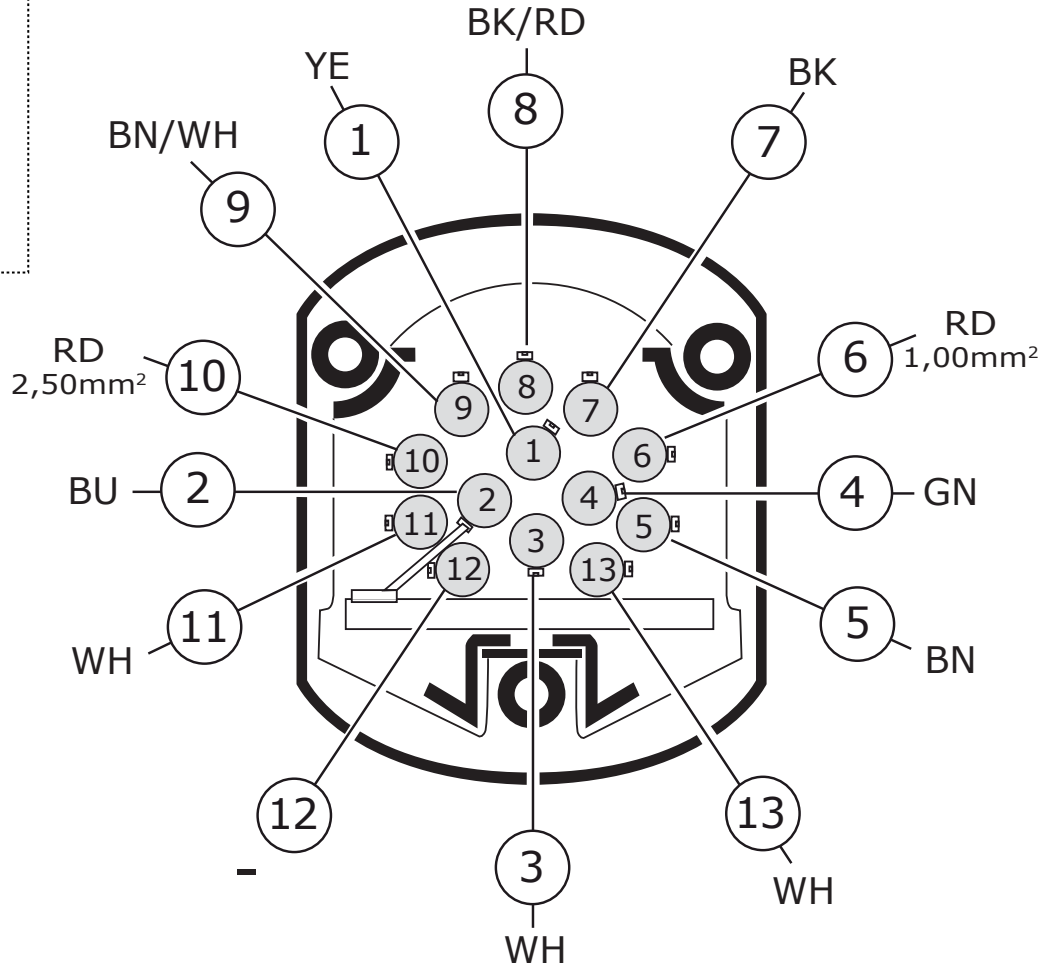
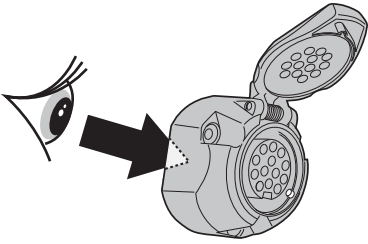

- (DE) Anschluss Steckdose (ES) Conexión de la caja de enchufe (CZ) Objímkový konektor (GR) Υποδοχή σύνδεσης
- (FR) Connection de la prise (IT) Allaccio zoccolo (DK) Stikdåse forbindelse (NO) Tilkobling koblingsboks
- (NL) Contactdoos aansluiting (SE) Anslutning kontaktdosa (FI) Pistorasia liitäntä (PL) Połączenie przez gniazdo
- (GB) Socket connection

DIN/ISO 11446													
Pmax	21W	21W		21W	42W	3x21W	42W	21W	180W/10Amp	180W/15Amp			
	YE	BU	WH	GN	BN	RD 1,00mm²	BK	BK/RD	BN/WH	RD 2,50mm²	WH	-	WH

COLORTABLE

	BK	BN	BU	GY	GN	WH	YE	OG	PE	PI	RD
(DE)	Schwarz	Braun	Blau	Grau	Grün	Weiß	Gelb	Orange	Violett	Rosa	Rot
(FR)	Noir	Marron	Blue	Gris	Vert	Blanc	Jaune	Orange	Violet	Rose	Rouge
(NL)	Zwart	Bruin	Blauw	Grijs	Groen	Wit	Geel	Oranje	Paars	Roze	Rood
(GB)	Black	Brown	Blue	Grey	Green	White	Yellow	Orange	Purple	Pink	Red
(ES)	Negro	Marrón	Azul	Gris	Verde	Blanco	Amarillo	Naranja	Morado	Rosa	Rojo
(IT)	Nero	Marrone	Blu	Grigio	Verde	Bianco	Giallo	Arancione	Viola	Rosa	Rosso
(SE)	Svart	Brun	Blå	Grå	Grön	Vit	Gul	Orange	Lila	Rosa	Röd
(CZ)	Černá	Hnědá	Modrá	Šedá	Zelená	Bílá	Žlutá	Oranžová	Fialová	Růžová	Červená
(DK)	Sort	Brun	Blå	Grå	Grøn	Hvid	Gul	Orange	Lilla	Pink	Rød
(FI)	Musta	Ruskea	Sininen	Harmaa	Vihreä	Valkoinen	Keltainen	Oranssi	Purppura	Vaaleanpunainen	Punainen
(GR)	Μαύρο	Καφέ	Μπλε	Γκρι	Πράσινο	Λευκό	Κίτρινο	Πορτοκαλί	Μοβ	Ροζ	Κόκκινο
(NO)	Svart	Brun	Blå	Grå	Grønn	Hvit	Gul	Oransje	Lilla	Rosa	Rød
(PL)	Czarny	Brazowy	Niebieski	Szary	Zielony	Biały	Żółty	Pomarańczowy	Purpurowy	Różowy	Czerwony

INFO POWER SCHEDULE BW-008-H1

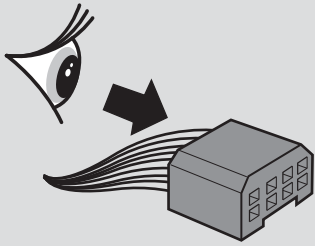

L		54	
R		54G	
58L		BU	
58R		Ground/31	

colortable **Pag. 3**

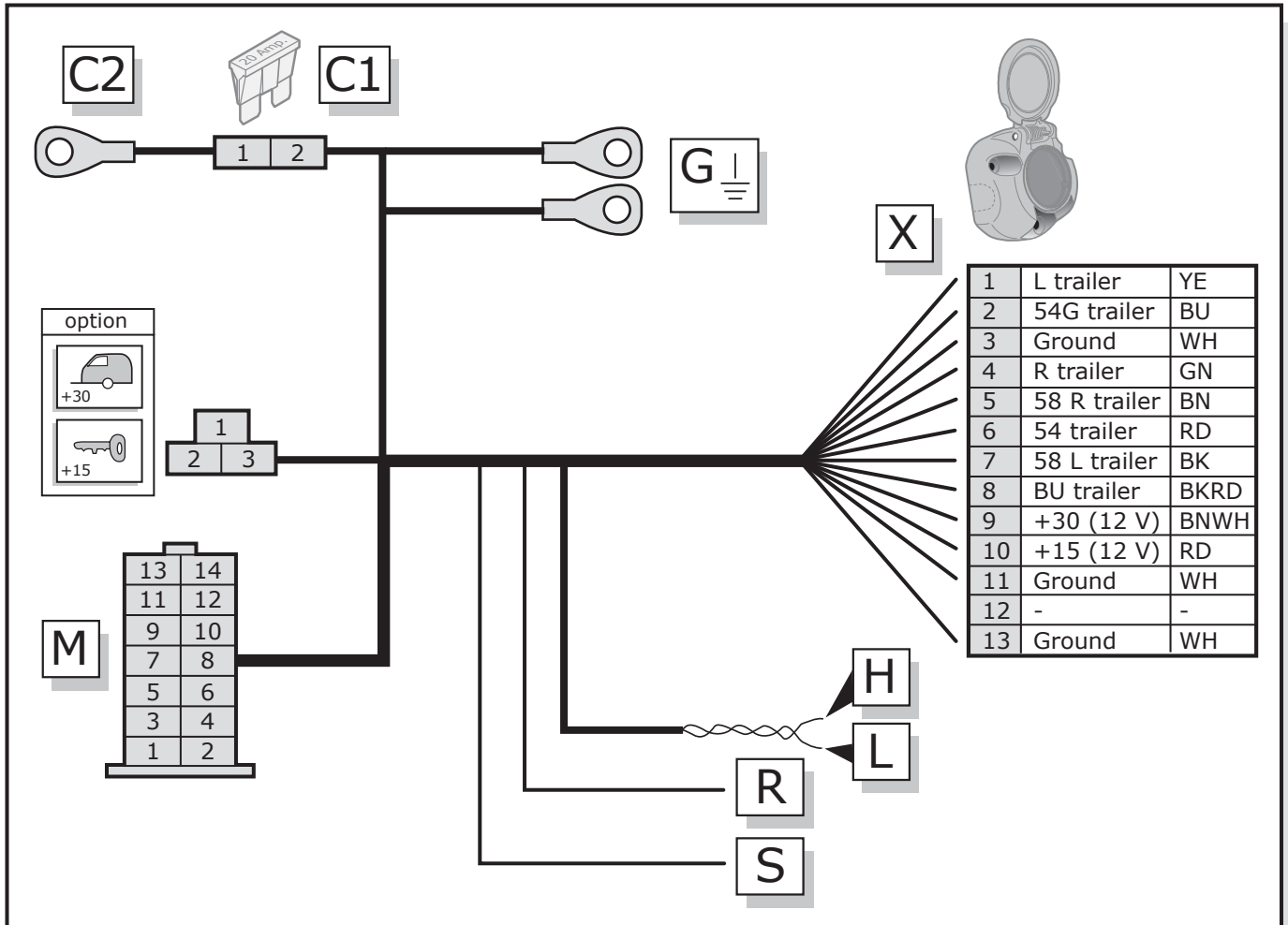

M	1	RD	54 trailer	out
	2	OG	+30 (12 V)	in
	3	RD/WH	R	in
	4	YE	L trailer	out
	5	BURD	54	in
	6	BK	58 L trailer	out
	7	GN	CAN L	in
	8	WH	Ground	-
	9	GN/OG	CAN H	in
	10	GN	R trailer	out
	11	BU	54G trailer	out
	12	BN	58 R trailer	out
	13	BKRD	BUT	out
	14	OG	+30	in

C1	1	RD	+30 (12 V)	in
	2	OG	+30 (12 V)	out

OPTION	1	-	-	-
	2	BN/WH	+30 (12 V)	in
	3	RD	+15 (12 V)	in

H	GN/OG	Can H	in
----------	-------	-------	----

L	GN	Can L	in
----------	----	-------	----

S	BU/RD	54	in
----------	-------	----	----

R	RD/WH	R	in
----------	-------	---	----

G	WH	Ground	-
----------	----	--------	---