

**Einbauanleitung Elektrosatz
Anhängervorrichtung mit 12-N Steckdose
lt. DIN/ISO Norm 11446**

**Instructions de montage du faisceau
électrique pour crochet d'attelage
conforme à la norme DIN/ISO 11446
prise 12-N**

**Fitting instructions electric wiringkit
towbar with 12-N socket up to
DIN/ISO norm 11446**

**Montage-handleiding elektrokabelset voor
trekhaak met 12-N contactdoos
vlg. DIN/ISO norm 11446**

**Istruzioni di montaggio cablaggio elettrico
per gancio di traino con presa 12-N con-
formemente alla Norma DIN/ISO 11446**

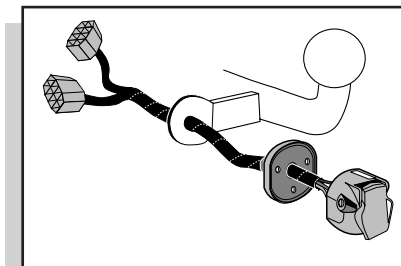

**VW SHARAN
SEAT ALHAMBRA
FORD GALAXY**

**1999-2000 + 2000-
1999-2000 + 2000-
1999-2000 + 2000-**

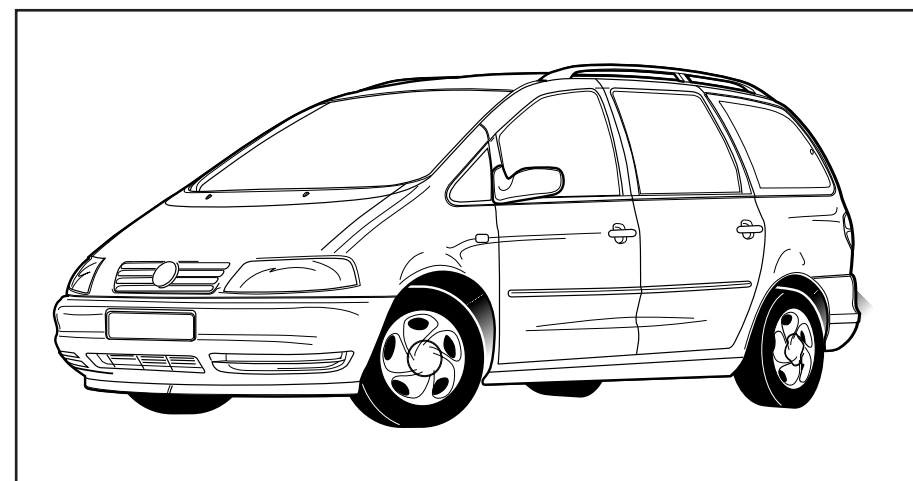

Bestel Nr.: VW-011-HB

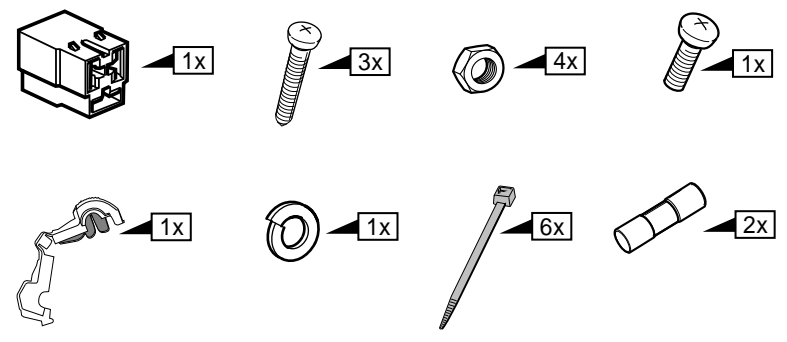
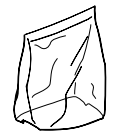
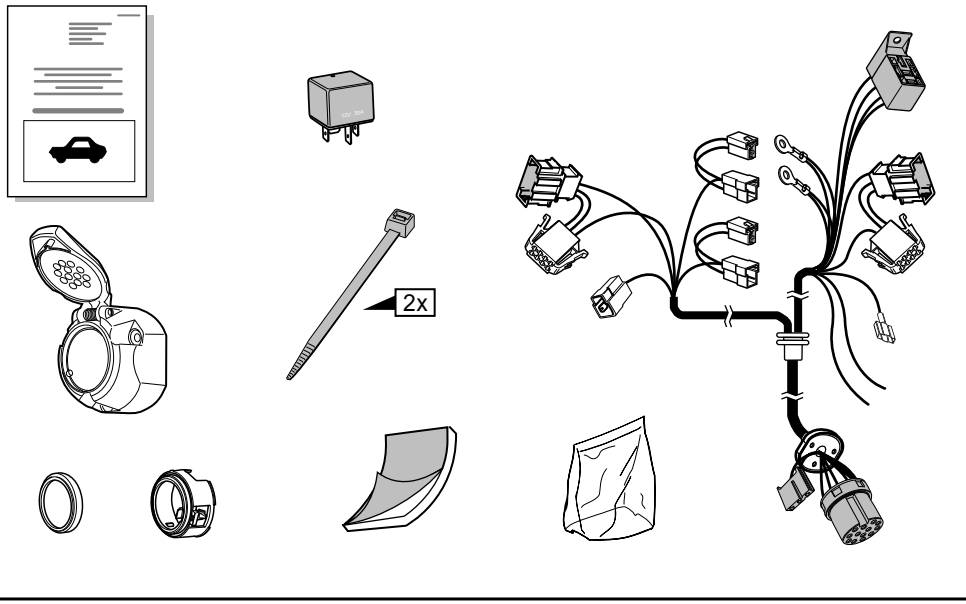
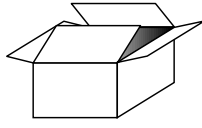

INFO

*Für das aktivieren der zweiten Kontrolleuchte (C2 Funktion), fragen Sie bitte Ihr Händler.

*Pour activer la deuxième lampe de contrôle (C2 fonction), consultez votre stockiste s.v.p.

*For activating the second direction indicator light (C2 function), please consult your dealer.

*Voor het actief maken van het tweede controlelampje (C2 functie), raadpleeg uw dealer.

*Per attivare la seconda luce di direzione (funzione C2) si prega di consultare il proprio rivenditore.

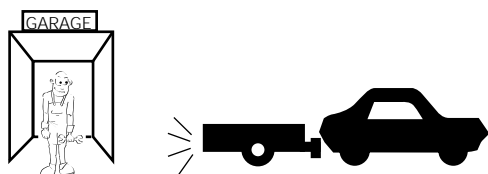
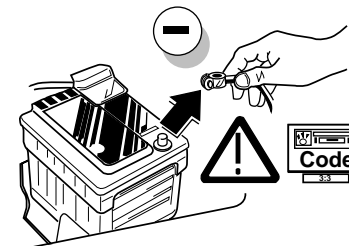
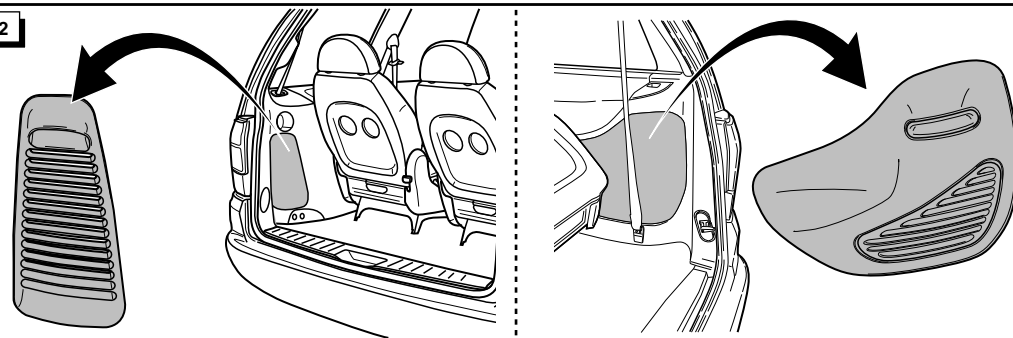
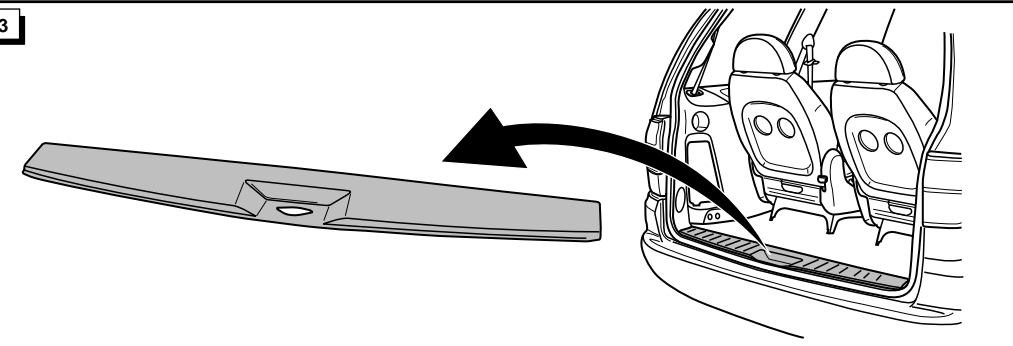
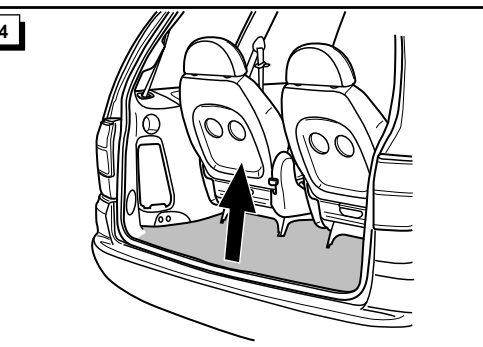
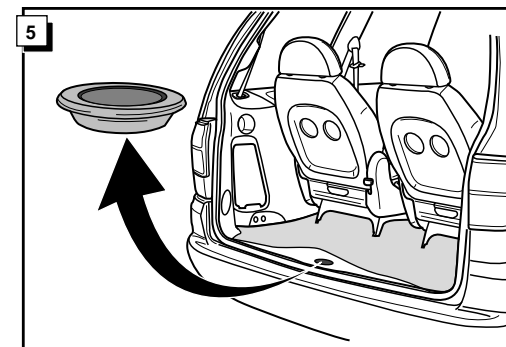
**1****2****3****4****5**

INFO

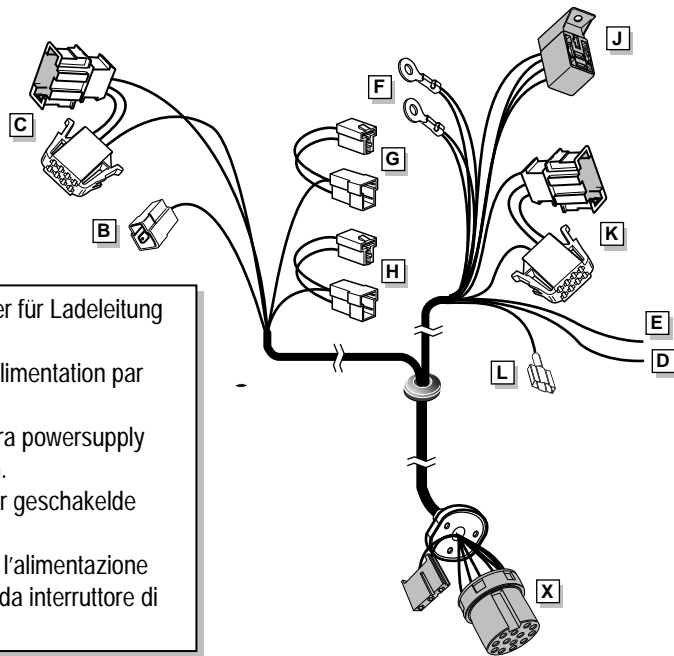

- B:** * Vorbereiteter steckverbinder für Ladeleitung plus für Batterie Anhänger.
* Connecteur préparé pour alimentation par contact.
* Prepared connector for extra powersupply controlled by ignition switch.
* Voorbereide connector voor geschakelde voeding.
* connettore predisposto per l'alimentazione supplementare, controllato da interruttore di accensione.

ROUTING

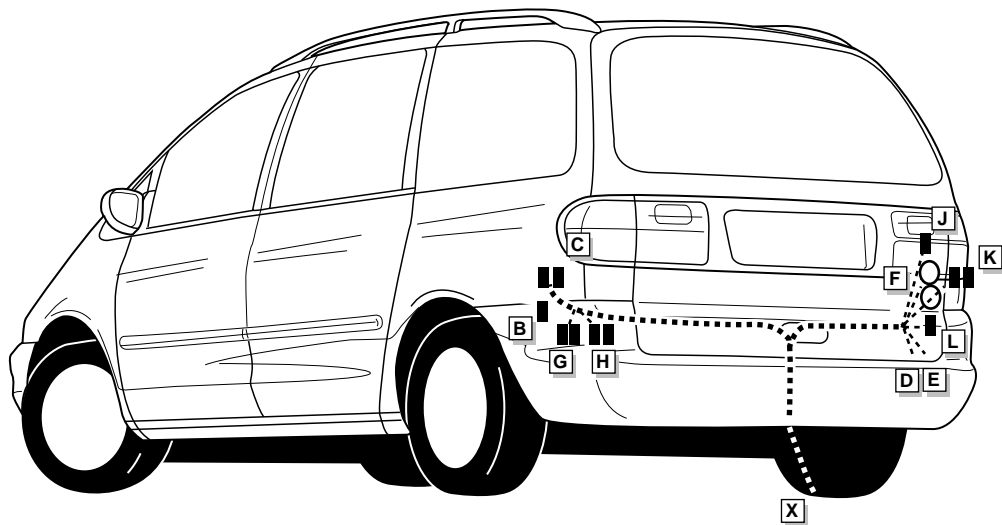

15

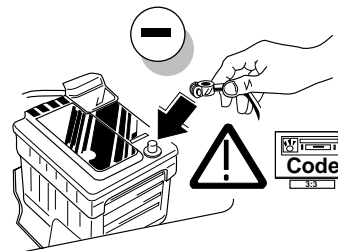

16

! FUNKTIONEN KONTROLLIEREN !
CONTRÔLER LES FONCTIONS !
CHECK FUNCTIONS !
CONTROLEER FUNCTIES !
CONTROLLARE LE FUNZIONI!

17

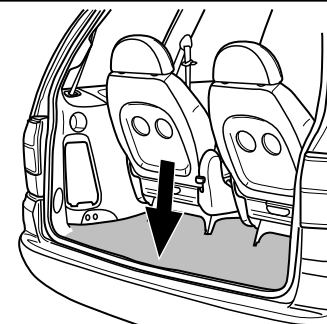

18

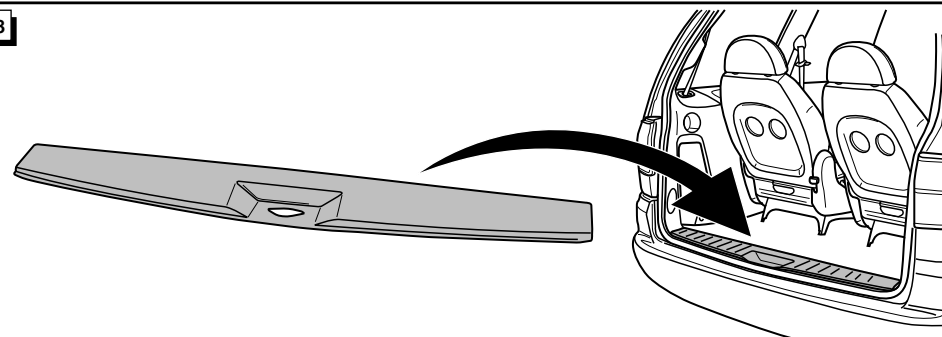

19

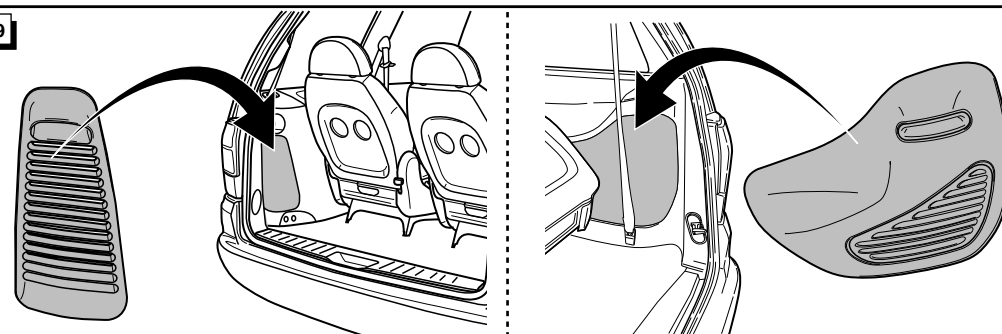

13

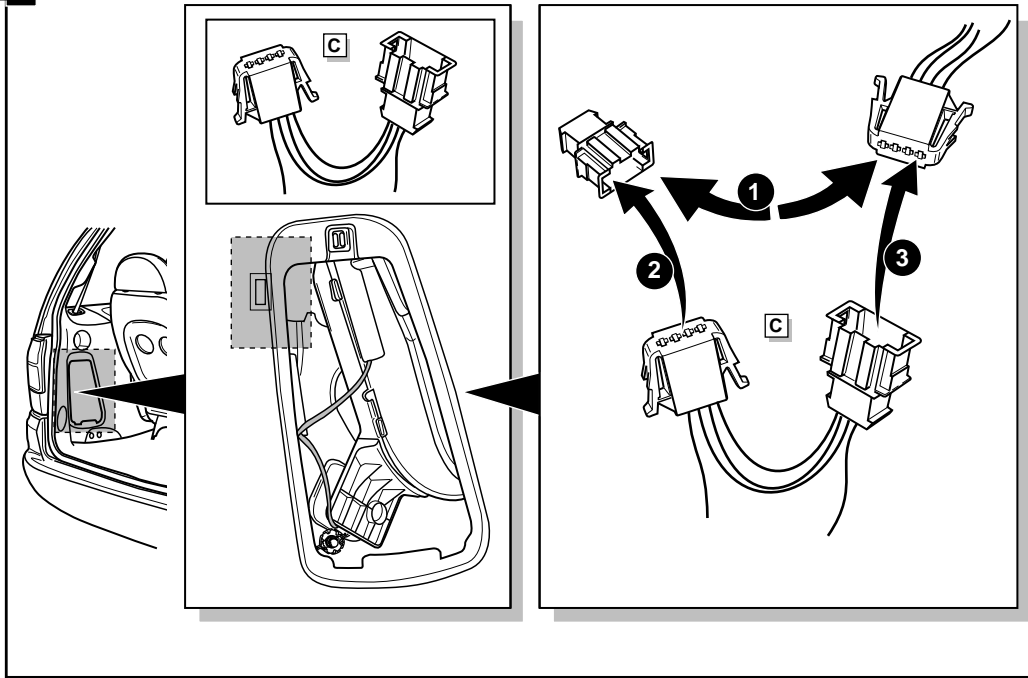

6

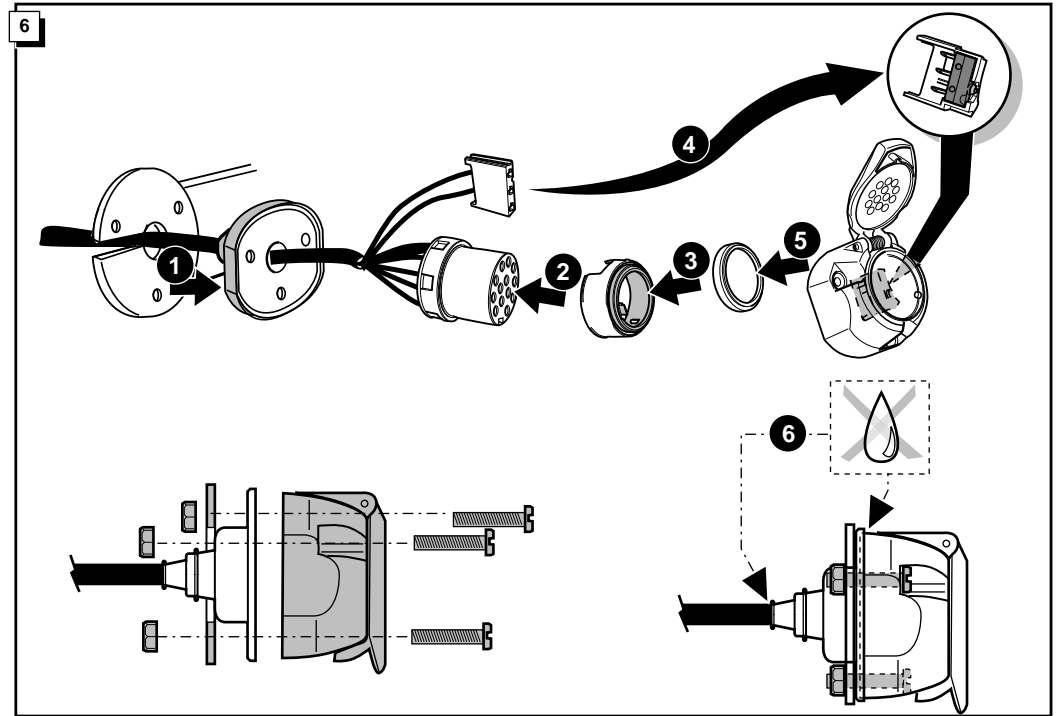

14

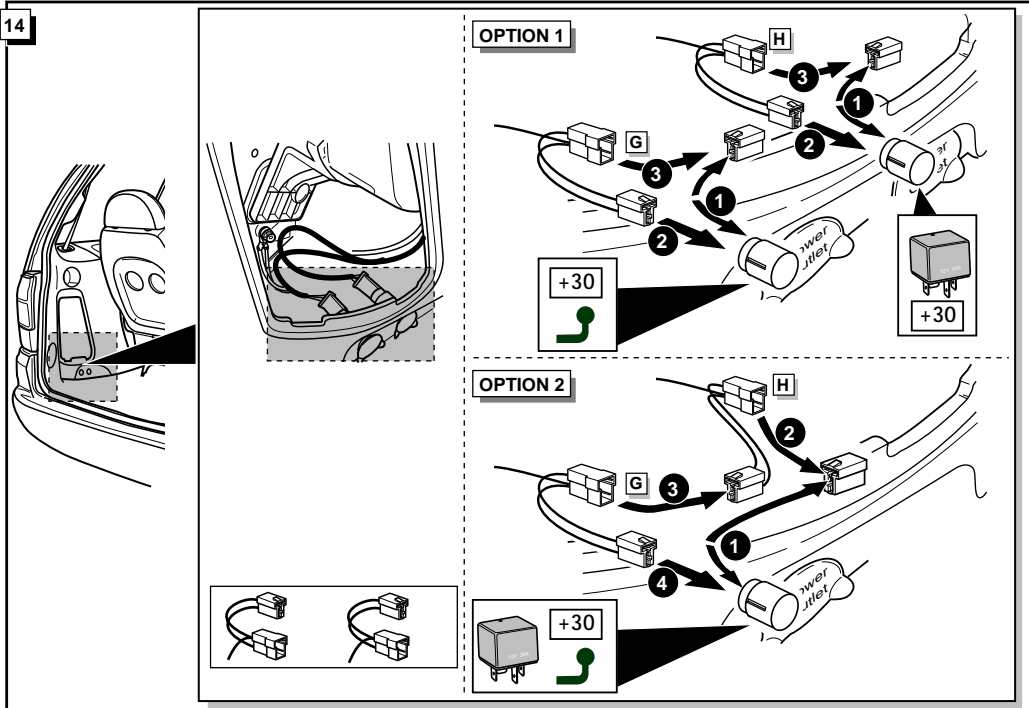

INFO

Anschluß Steckdose / Connection de la prise / Socket connection / Contactdoos aansluiting / Collegamento alla presa

DIN/ISO 11446		(D)	(F)	(GB)	(NL)	(IT)
←	1/L	gelb	jaune	yellow	geel	giallo
↶	2	blau	bleu	blue	blauw	blu
↷	2a	grau	gris	grey	grijs	grigio
⊖	1-8	weiß	blanc	white	wit	bianco
↷	4/R	grün	vert	green	groen	verde
☀	5/58-R	braun	marron	brown	bruin	marrone
STOP	6/54	rot	rouge	red	rood	rosso
☀	7/58-L	schwarz	noir	black	zwart	nero
↶↷	8	schwarz/rot	noir/rouge	black/red	zwart/rood	nero/rosso
↷	9	braun/weiß	marron/blanc	brown/white	bruin/wit	marrone/bianco
↷	10	rot	rouge	red	rood	rosso
⊖	10	weiß	blanc	white	wit	bianco
↶	12	rot/blau	rouge/bleu	red/blue	rood/blauw	rosso/blu
⊖	13	weiß	blanc	white	wit	bianco

