

! INFO !

- (DE) Die Batterie des Zugfahrzeugs bzw. gezogenen Fahrzeugs nicht direkt über die Steckdose aufladen.
- (FR) Ne pas charger les batteries du véhicule tracteur et/ou tracté directement sur la prise de courant.
- (NL) De accu van het trekkend voertuig c.q. getrokken voertuig niet rechtstreeks via de contactdoos opladen.
- (GB) Do not charge the battery of the towing vehicle and/or towed vehicle directly via the socket.
- (ES) No recargue la batería del vehículo remolque y/o del remolcado directamente mediante el enchufe.
- (IT) Non caricare la batteria del veicolo trainante o di quello trainato direttamente dalla presa.
- (SE) Ladda inte batteriet i det bogserande fordonet och/eller det bogserade fordonet direkt via kontakten.
- (CZ) Nenabíjajte baterii tažného ani taženého vozidla přes zásuvku.
- (DK) Oplad ikke bugseringskøretøjet og/eller det bugserede køretøjs batteri direkte v.h.a. stikdåsen.
- (FI) Älä lataa hinaavan ajoneuvon ja/tai hinattavan ajoneuvon akkuja suoraan pistorasian kautta.
- (GR) Μη φορτίζετε την μπαταρία του ρυμουλκούμενου οχήματος και/ή ρυμουλκημένου οχήματος απευθείας μέσω του ρευματοδότη.
- (NO) Batteriet til kjøretøyet som trekker eller blir trukket skal ikke lades direkte via koblingsboksen.
- (PL) Nie ładować akumulatora pojazdu holującego/holowanego bezpośrednio przez gniazdo.

- (DE) Gebrauchsanleitung
(FR) Mode d'emploi
(NL) Gebruikershandleiding
(GB) User guide
(ES) Guía del usuario
(IT) Manuale di istruzioni
(SE) Bruksanvisning
(CZ) Uživatelská příručka
(DK) Brugervejledning
(FI) Käyttöohjeet
(GR) Οδηγός χρήστη
(NO) Brukerveiledning
(PL) Instrukcja obsługi

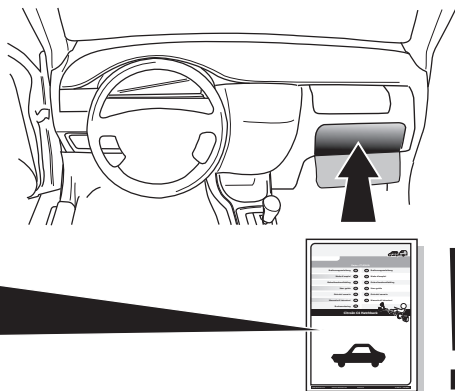

SPARE PARTS

www.ecs-electronics.com

ECS

ELECTRONICS



Partnr.: VL-022-DX

Gebrauchsanleitung (DE)

(CZ) Uživatelská příručka

Mode d'emploi (FR)

(DK) Brugervejledning

Gebruikershandleiding (NL)

(FI) Käyttöohjeet

User guide (GB)

(GR) Οδηγός χρήστη

Guía del usuario (ES)

(NO) Brukerveiledning

Manuale di istruzioni (IT)

(PL) Instrukcja obsługi

Bruksanvisning (SE)

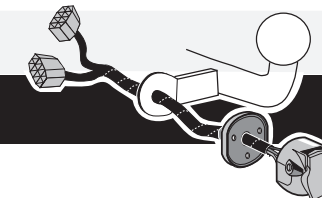

Volvo C70 02/2006-

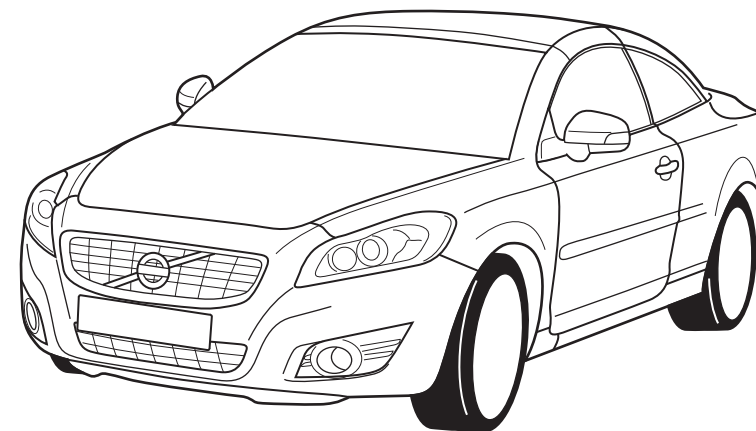

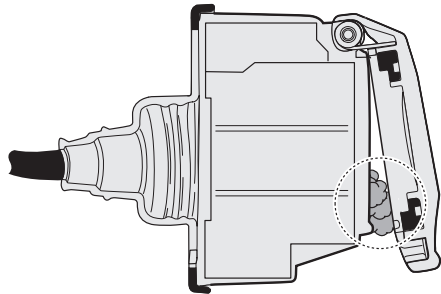

- | | | | |
|------------------------------|----------------------------|------------------------------|----------------------------|
| (DE) Sicherungen austauschen | (ES) Cambio de fusible | (CZ) Výměna pojistky | (GR) Αλλαγή ασφάλειας |
| (FR) Remplacer les fusibles | (IT) Sostituire i fusibili | (DK) Udsiftning af sikringer | (NO) Skifte sikringene |
| (NL) Zekeringen vervangen | (SE) Byte av säkringar | (FI) Vaihda varokkeet | (PL) Wymienić bezpieczniki |
| (GB) Changing the fuse | | | |

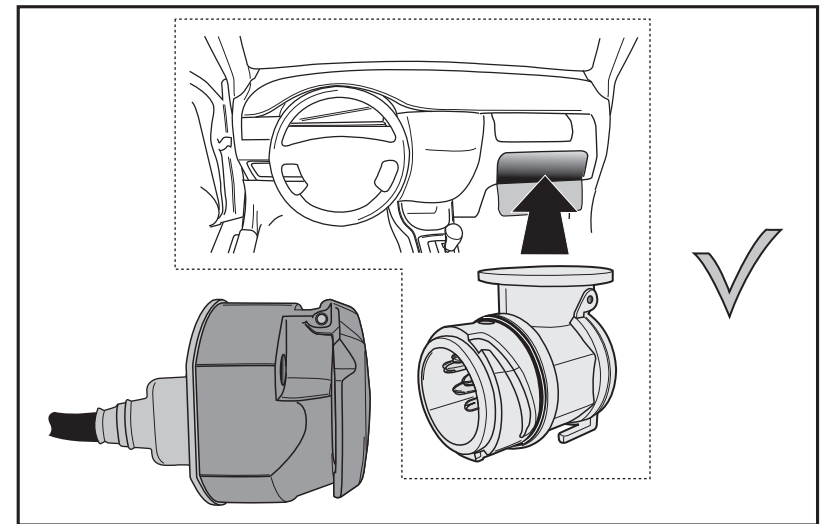
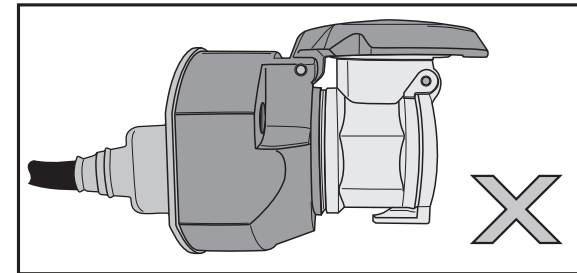
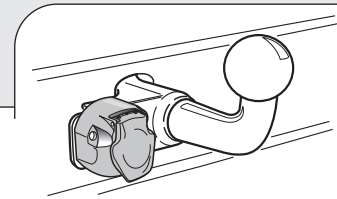
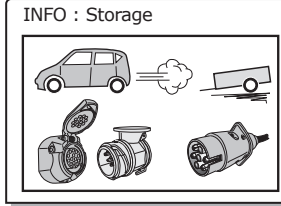
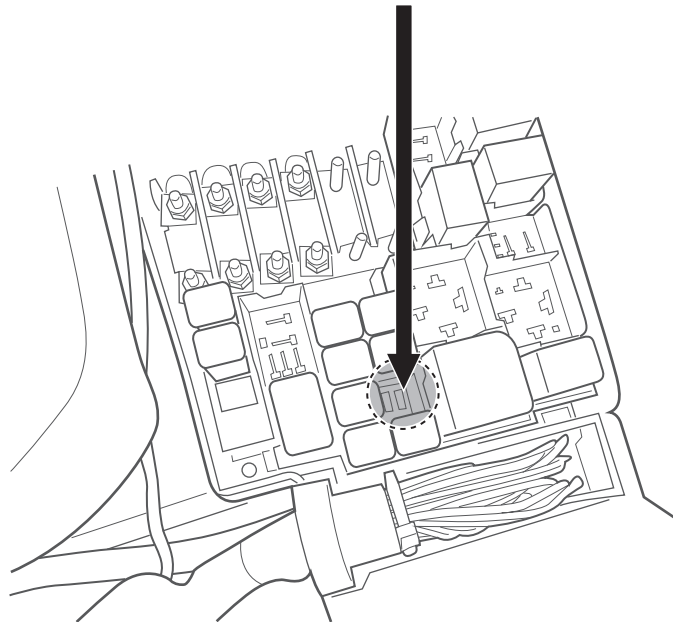
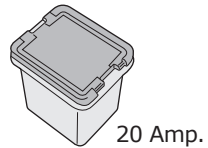
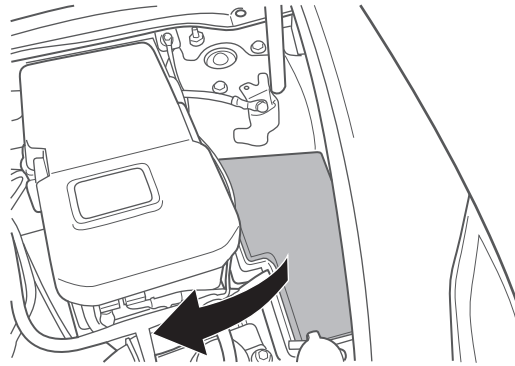
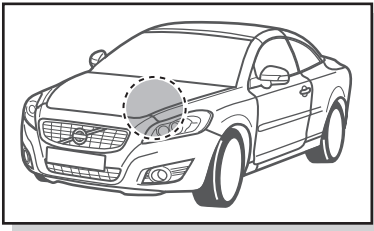

INFO : Ring.

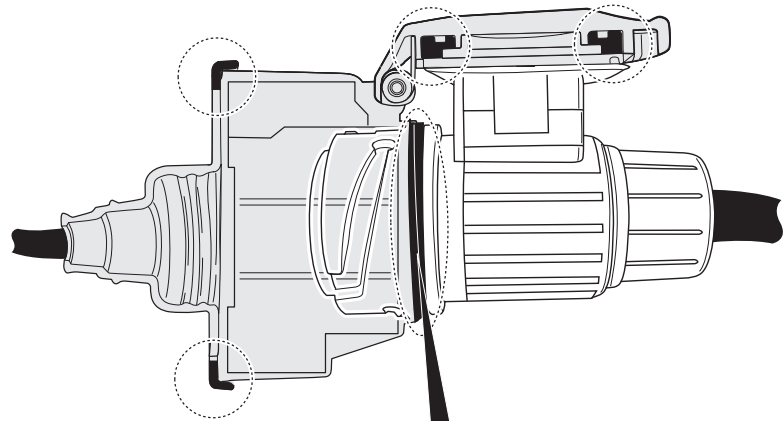
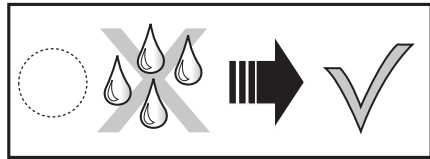
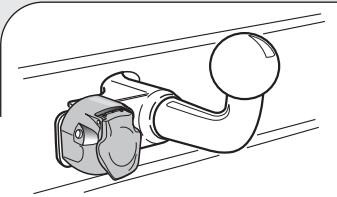
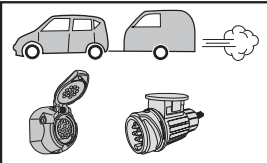

INFO

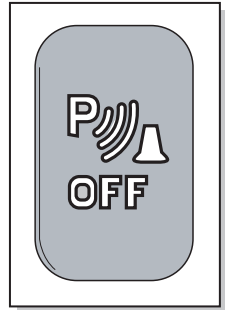
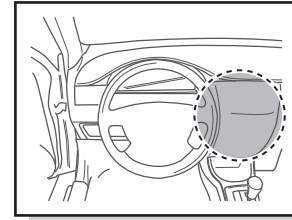
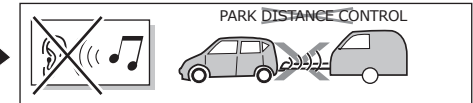
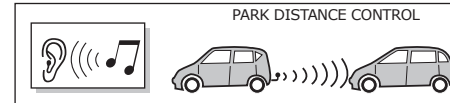
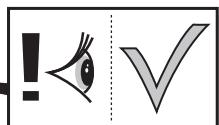
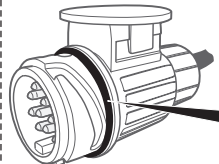
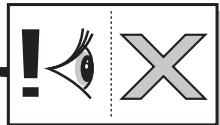
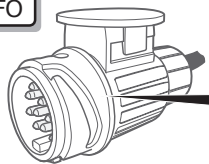

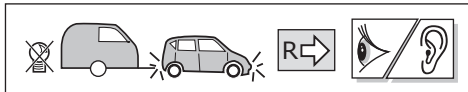

DE Die Blinklichter am Anhänger werden überwacht. Wenn einer der Anhängerblinker kaputt ist, ertönt ein Summerton und/oder es erscheint ein optisches Signal auf dem Armaturenbrett. Kontrollieren Sie die Blinklichter am Anhänger.

FR Les clignotants de la remorque sont protégés. En cas de défaut à l'un des clignotants du véhicule tracté, un signal sonore sera émis et/ou un signal visuel sera affiché sur le tableau de bord. Vérifiez les clignotants de la remorque.

NL De knipperlichten op de aanhanger worden bewaakt. Indien één van de aanhangerknipperlichten defect is zal er een zoemer te horen zijn en/of een visueel signaal op het dashboard waarneembaar zijn. Controleer de knipperlichten op de aanhanger.

GB The flashing lights on the trailer are monitored. If one of the indicators of the trailer breaks down, a buzzer will be audible and/or a visual signal will be visible on the dashboard. Check the flashing lights on the trailer.

ES Las luces intermitentes del remolque son supervisadas. En caso de que una de las luces intermitentes del remolque esté defectuosa, se emitirá un zumbido y/o se podrá observar una señal visual en el tablero de instrumentos. Revise las luces intermitentes del remolque.

IT I lampeggiatori del rimorchio sono controllati. Se una delle frecce del rimorchio è guasta, si udirà un segnale acustico e/o comparirà un segnale visivo sul cruscotto. Controllare i lampeggiatori del rimorchio.

SE Blinkrarna på släpet bevakas. Om ett av släpets blinkljus är sönder hörs en varningssummer och/eller tänds ett varningsljus på instrumentbrädan. Kontrollera släpets blinkerslampor.

CZ Ukazatele směru na přívěsu jsou kontrolovány. Pokud dojde k poruše jednoho z indikátorů taženého vozidla, ozve se výstražný signál a/nebo se rozsvítí příslušná kontrolka na palubní desce. Zkontrolujte ukazatele směru na přívěsu.

DK Blinklysene på anhængerens overvåges. Hvis et af anhængerblinklysene er defekt høres en alarmlyd og/eller vises der et advarselssignal på instrumentbrættet. Kontroller blinklysene på anhængerens.

FI Perävaunun suuntavalaja valvotaan avulla. Älä lataa hinaavan ajoneuvon ja/tai hinattavan ajoneuvon akkuja suoraan pistorasian kautta. Tarkasta perävaunun suuntavalot.

GR Οι φανοί αναλαμπών του ρυμουλκού ελέγχονται. Σε περίπτωση που κάποιος από τους δείκτες του ρυμουλκούμενου οχήματος υποστεί βλάβη, θα μπορεί να ακουστεί ο βομβητής και/ή θα είναι ορατό ένα οπτικό σήμα στον πίνακα οργάνων. Ελέγξτε τους φανούς αναλαμπής του ρυμουλκού.

NO Blinklysene på tilhengeren blir kontrollert. Hvis et av påhengsvognens blinklys er defekt, vil du høre en summelyd og/eller se et varsellys på dashbordet. Kontroller tilhengerens blinklys.

PL Kierunkowskazy na przyczepie są kontrolowane. Jeżeli jeden ze wskaźników przyczepy przestanie działać, włączy się sygnał dźwiękowy i/lub sygnał wizualny pojawi się na tablicy rozdzielczej. Należy wówczas sprawdzić kierunkowskazy na przyczepie.

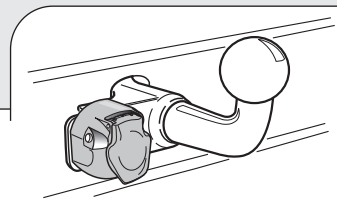

INFO : Adapt.

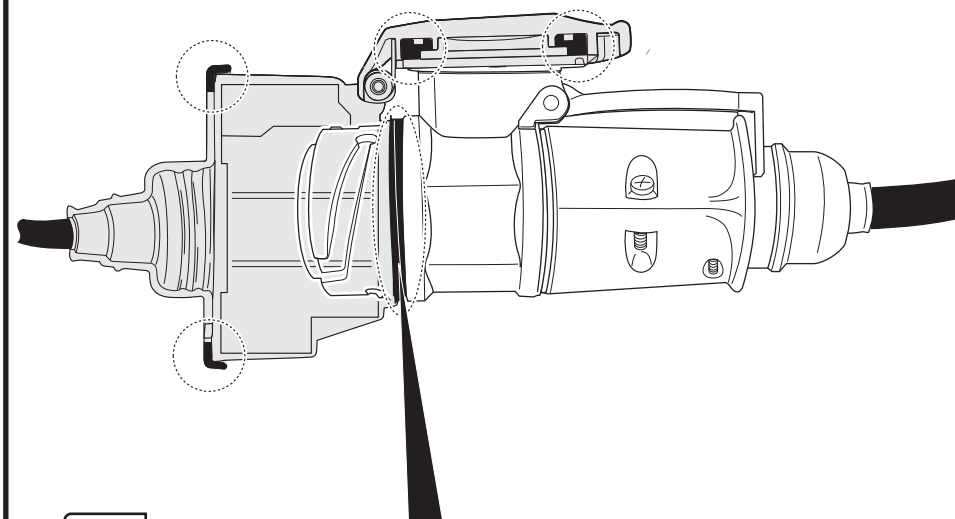
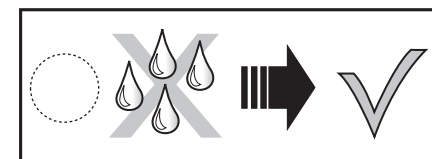
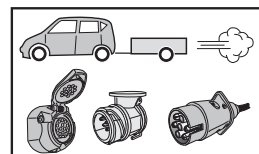

INFO

