

SsangYong Actyon 06/2006-

Partnr.: SY-006-BL

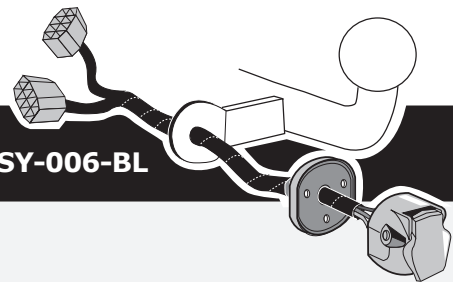

DE Einbauanleitung Elektrosatz Anhängervorrichtung mit 12-N Steckdose It. DIN/ISO Norm 1724.

FR Instructions de montage du faisceau électrique pour crochet d'attelage conforme à la norme DIN/ISO 1724 prise 12-N

NL Montage-handleiding elektrokabelset voor trekhaak met 12-N contactdoos vlg. DIN/ISO norm 1724.

GB Fitting instructions electric wiring kit tow bar with 12-N socket up to DIN/ISO Norm 1724.

ES Instrucciones de montaje de kit eléctrico para enganche de remolque con caja de conexiones 12-N según norma DIN/ISO 1724.

IT Istruzioni di montaggio di set di cavi elettrici per gancio da traino con zoccolo a 12 N conforme alla norma DIN/ISO 1724.

SE Monteringsanvisningar elkabelsats för dragkrok med 12-N kontaktdosa enligt DIN/ISO norm 1724.

CZ Montážní pokyny: souprava pro elektrické propojení tažné tyče s 12 - N zásuvkou do normy DIN/ISO 1724.

DK Monteringsvejledninger for det elektriske ledningsføringssæt for trækstang med 12-N stikdåse, DIN/ISO, norm 1724.

FI Ohjeet vetokoukun sähkökaapelisarjan asentamiseen, jossa on DIN/ISO 1724 mukainen 12-N liitin.

GR Οδηγίες συναρμολόγησης ηλεκτρικού σετ καλωδίων μπάρας ρυμούλκησης με υποδοχή 12-N μέχρι DIN/ISO Κανόνας 1724.

NO Monteringsanviser elkabelsett for trekrok med 12-N koblingsboks ifølge DIN/ISO norm 1724.

PL Instrukcje montażu zestawu okablowania elektrycznego dyszla holowniczego z 12-N stykowym gniazdem DIN/ISO 1724.

DE - Wir weisen ausdrücklich darauf hin, dass eine unsachgemäße und nicht in einer Fachwerkstatt durchgeführte Montage einen Verzicht auf Entschädigung jeglicher Art insbesondere bezüglich des Produkthaftpflichtrechts zur Folge hat

FR - Il est expressément prévu qu' on ne saurait se prévaloir d'un quelconque préjudice contractuel ou rédhibitoire si le montage avait été fait en dépit des dites instructions ou dans un garage ne disposant pas des équipements adéquats.

NL - Wij wijzen er met nadruk op, dat ondeskundige en niet door een vakkundige werkplaats uitgevoerde montage tot gevolg heeft dat daardoor ieder recht op schadevergoeding, ook op wettelijke aansprakelijkheid inzake producten, vervalt.

GB - We would expressly point out that assembly not carried out properly by a competent installer will result in cancellation of any right to damage compensation, in particular those arising by virtue of the product liability act.

ES - El montaje inapropiado y efectuado por personal no cualificado originará la pérdida de todo derecho a indemnización o la expiración de toda responsabilidad civil con respecto al producto.

IT - Sottolineiamo espressamente che un montaggio inadeguato ed eseguito da un'officina non specializzata ha come conseguenza il decadere di qualsiasi diritto al risarcimento danni, nonché alla responsabilità legale relativa ai prodotti.

SE - Vi påpekar med eftertryck att all rätt till skadeersättning och all laglig ansvarighet förfaller om monteringen inte har utförts på rätt sätt och av en professionell verkstad.

CZ - Výslovně zdůrazňujeme, že jakákoli montáž, která není provedená ve specializované dílně, má za následek odvolání nároků na kompenzaci jakéhokoliv druhu, obzvláště vyplývajících ze zákona o odpovědnosti za způsobené škody.

DK - Vi ønsker at gøre udtrykkeligt opmærksom på at forkert samling, der ikke er udført af et specialiseret værksted, resulterer i bortfaldelse af kompenseringskrav af alle slags, i særdeles krav der måtte opstå omkring det lovpligtige ansvar.

FI - Korostamme, että kaikki oikeudet vahinkokorvaukseen kuten myös valmistajan laillinen vastuu raukeavat, mikäli asennusta ei ole toteutettu oikealla tavalla eikä ammattitaitoisen asiantuntijan toimesta.

GR - Επισημαίνουμε κατηγορηματικά ότι οποιαδήποτε εσφαλμένη συναρμολόγηση, η οποία δεν έχει πραγματοποιηθεί ειδικό εργαστήριο θα οδηγήσει σε απονοίση των αξιώσεων επιβολής αποζημιώσεων οποιαδήποτε είδους, ειδικά όσα προκύπτουν από το νόμο ευθύνης προϊόντων.

NO - Vi påpeker ettertrykkelig at all rett til skadeerstatning og rettslig ansvar forfaller dersom monteringen ikke er blitt utført på riktig måte og av et profesjonelt verksted.

PL - Chciłbyśmy wyraźnie zaznaczyć, iż wszelki nieprawidłowy montaż, który nie jest wykonywany w specjalistycznym warsztacie pociąga za sobą utratę możliwości dochodzenia wszelkiego typu roszczeń, w szczególności tych wynikających z odpowiedzialności producenta za swój produkt.

- Technische Änderungen vorbehalten.

- Widerstand nur gemäß der Tabelle auf dem Anhänger verwenden, siehe Seite 10.

- Sous réserve de modifications techniques.

- Ne excédez pas la charge maximale, indiquée dans le tableau sur page 10.

- Technische wijzigingen voorbehouden.

- Gebruik alleen belasting volgens aansluittabel op het getrokken voertuig, zie pagina 10.

- Contents of these kits and their fitting manuals are subject to alteration without notice, please ensure that these instructions are read and fully understood before commencing installation.

- Do not overload circuits; the maximum loads per connection are detailed in this manual.

- Nos reservamos el derecho a efectuar modificaciones técnicas.

- Utilice sólo cargas de acuerdo a la tabla de conexión del vehículo remolcado (ver página 10).

- Ci si riserva il diritto di apportare modifiche tecniche.

- Utilizzare esclusivamente un carico conforme alla tabella degli allacci relativa al veicolo in questione, cfr. pagina 10.

- Tekniska ändringar förbehålles.

- Använd endast belastning enligt anslutningstabellen på det dragna fordonet, se sid. 10.

- Změny mohou být provedeny bez oznámení.

- Používejte pouze při maximálním nabití podle tabulky na tažném vozidle, viz. str. 10.

- Kan ændres uden varsel.

- Brug kun den maksimale belastning, i overensstemmelse med forbindelsestabelen for bugserede køretøjer, side 10.

- Oikeus teknisiin muutoksiin ilman erillistä huomautusta pidetään.

- Kuormita työvirtapiiriä ainoastaan hinattavan ajoneuvon kytkentäkaavion mukaisesti, katso sivu 10.

- Μπορεί να τροποποιηθεί χωρίς προηγούμενη ειδοποίηση.

- Χρησιμοποιείτε μόνο μέγιστο ηλεκτρικό φορτίο σύμφωνα με τον πίνακα σύνδεσης στο ρυμούλκούμενο όχημα, δείτε σελίδα 10.

- Tekniske endringer forbeholdes. - Overskrid ikke grensene anvist i tilkoblingstabellen på tilhengeren eller det tilkoblede kjøretøyet, se s. 10.

- Podlega zmianom bez powiadomienia.

- Używać tylko takiego maksymalnego obciążenia które wynika z tabliczki połączeń holowanego pojazdu, patrz strona 10.

Einzelteilliste

Liste de pièces

Onderdelenlijst

Part list

Lista de componentes

Elenco componenti

Dellista

Seznam dílů

Del-liste

Osaluettelo

Κατάλογος εξαρτημάτων

Delliste

Lista części

(DE)

(FR)

(NL)

(GB)

(ES)

(IT)

(SE)

(CZ)

(DK)

(FI)

(GR)

(NO)

(PL)

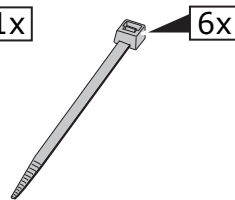
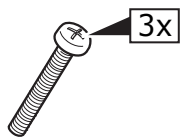
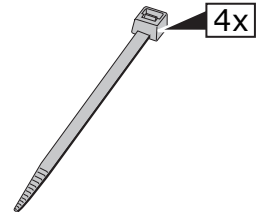
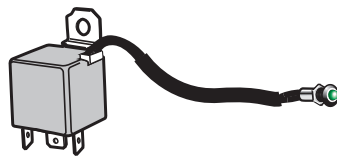
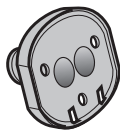
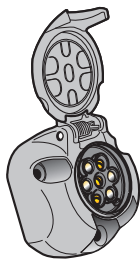
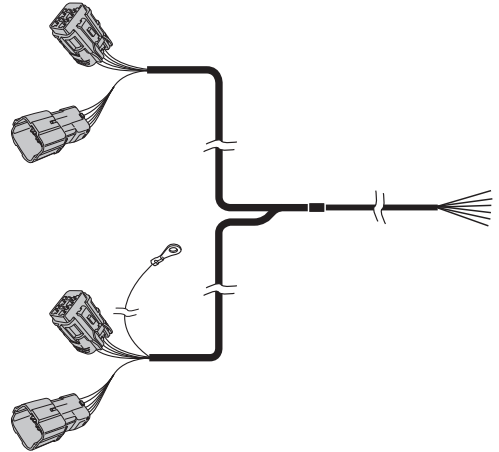
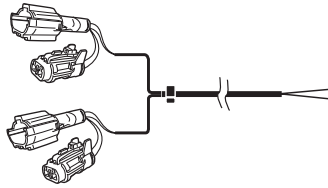
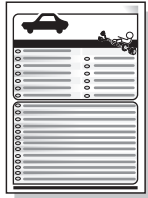
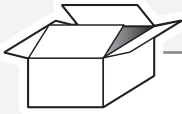

1

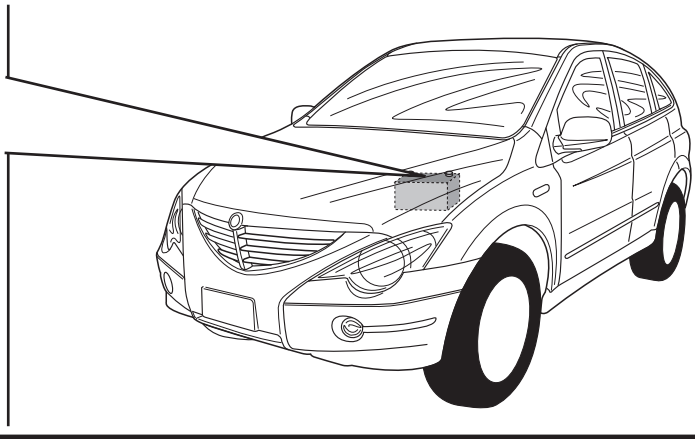
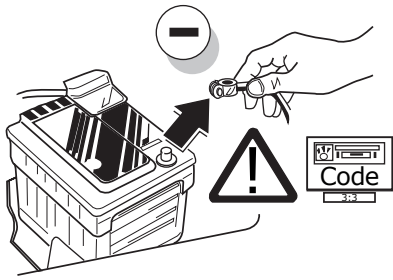

2

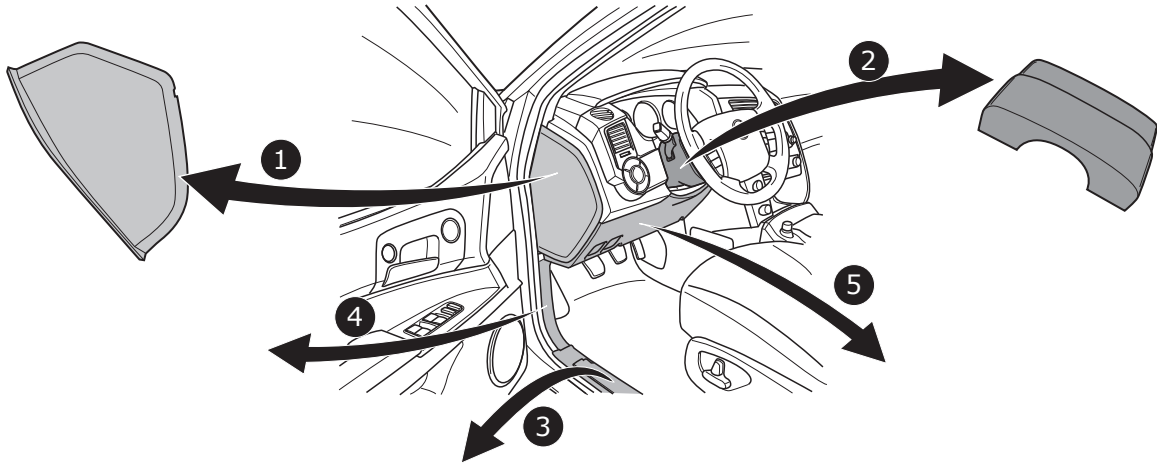

3

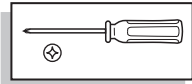
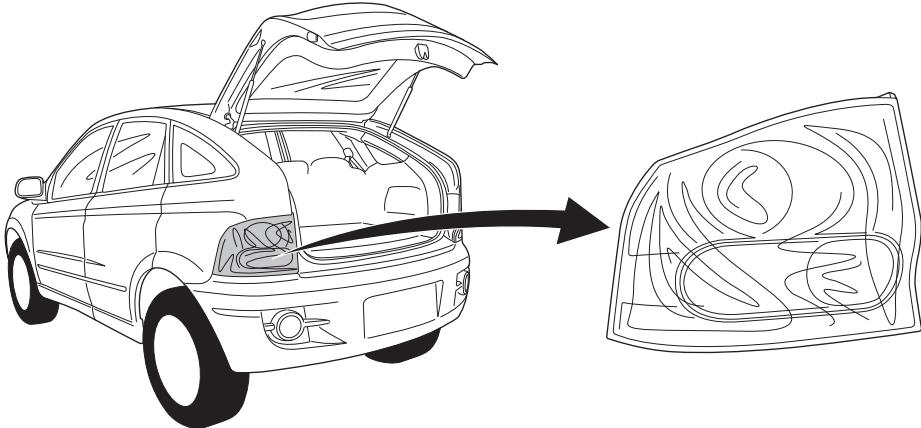

4

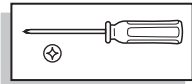
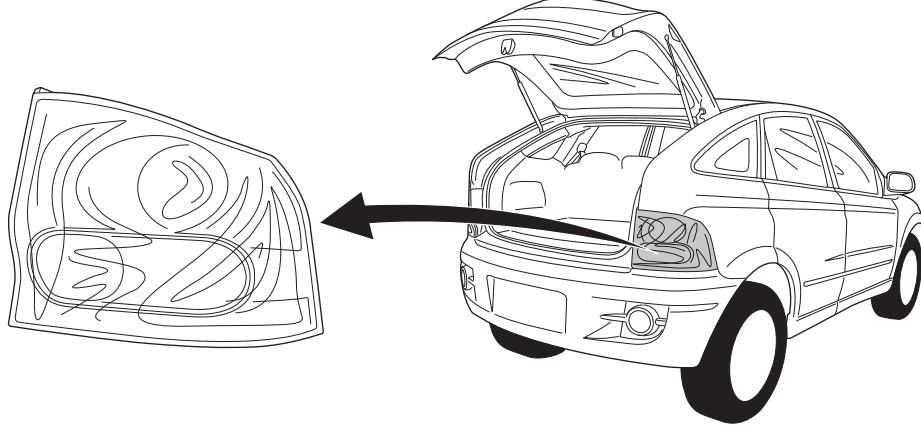

INFO

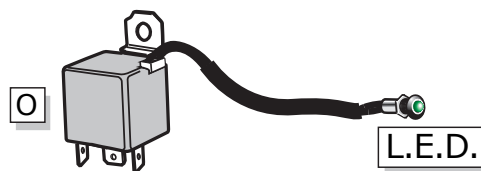
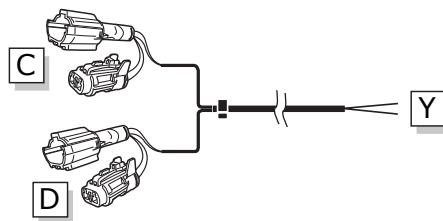
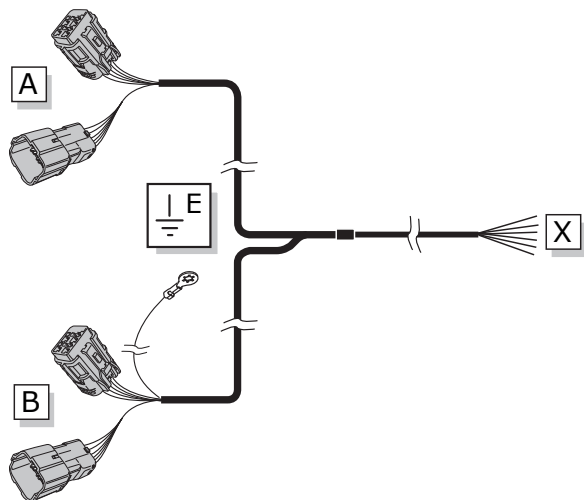

ROUTING

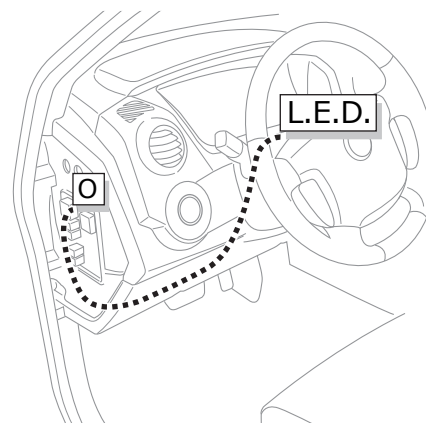
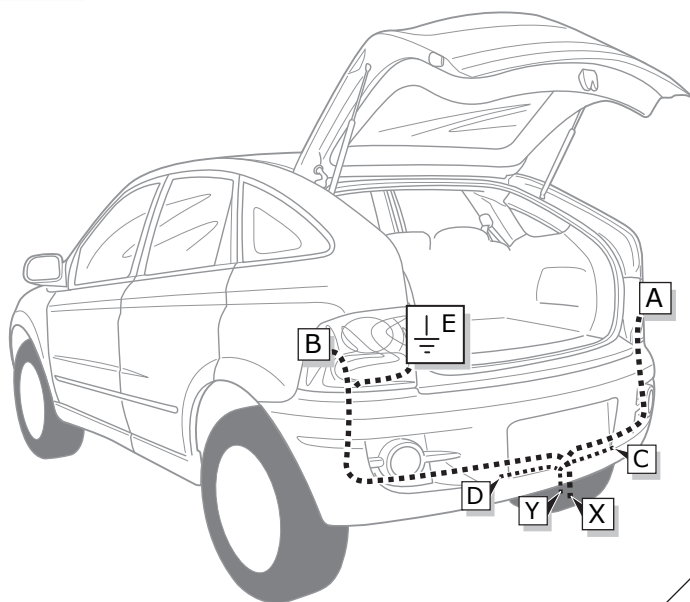

A

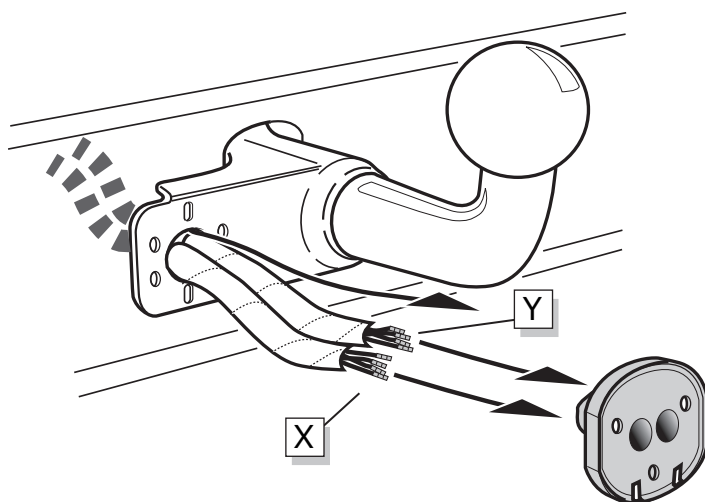

INFO

- | | |
|----------------------------------|----------------------------|
| Ⓓ Anschluss Steckdose | Ⓔ Anslutning kontaktdosa |
| Ⓕ Connection de la prise | Ⓕ Objímkový konektor |
| Ⓖ Contactdoos aansluiting | Ⓗ Stikdåse forbindelse |
| Ⓖ Socket connection | Ⓕ Pistorasia liitäntä |
| Ⓔ Conexión de la caja de enchufe | Ⓕ Υποδοχή σύνδεσης |
| Ⓕ Allaccio zoccolo | Ⓗ Tilkobling koblingsboks |
| | Ⓕ Połączenie przez gniazdo |



Pag. 10

B

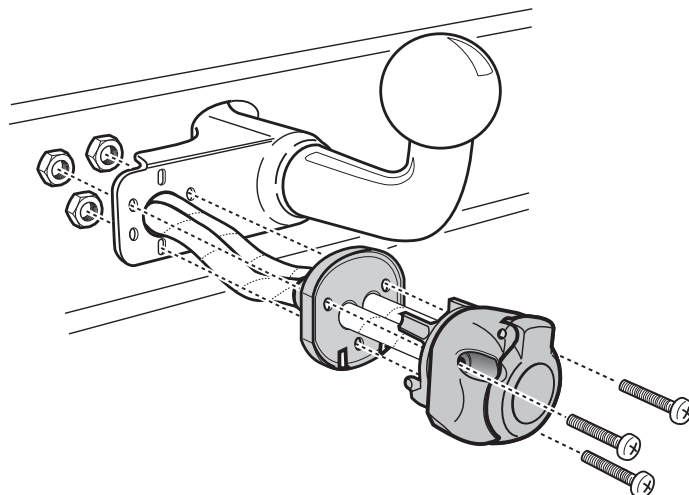

5

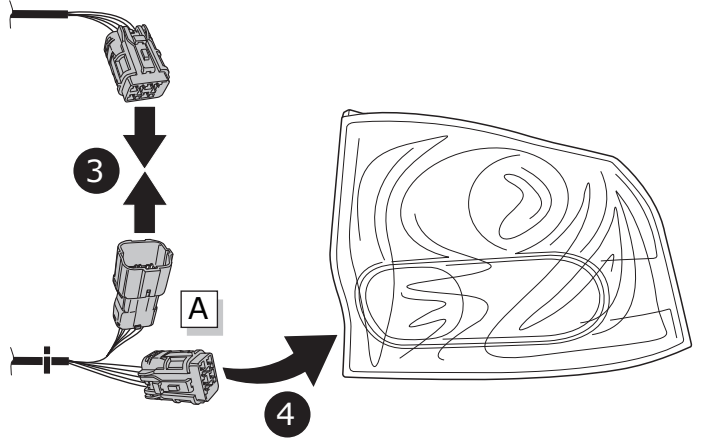
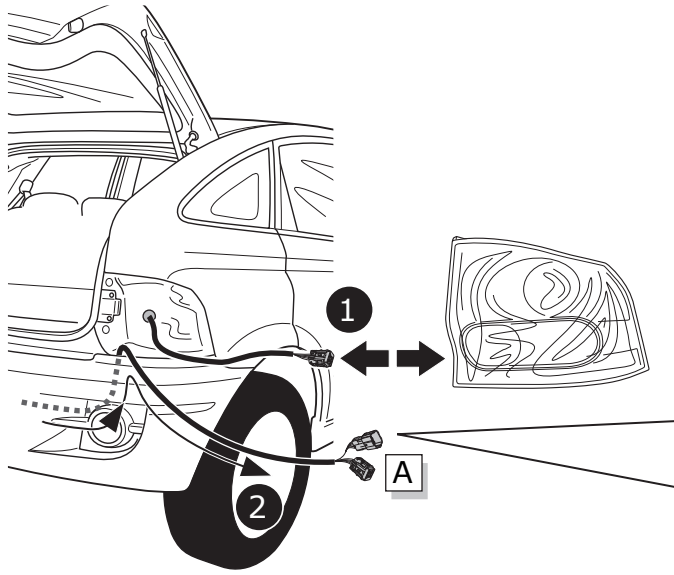

6

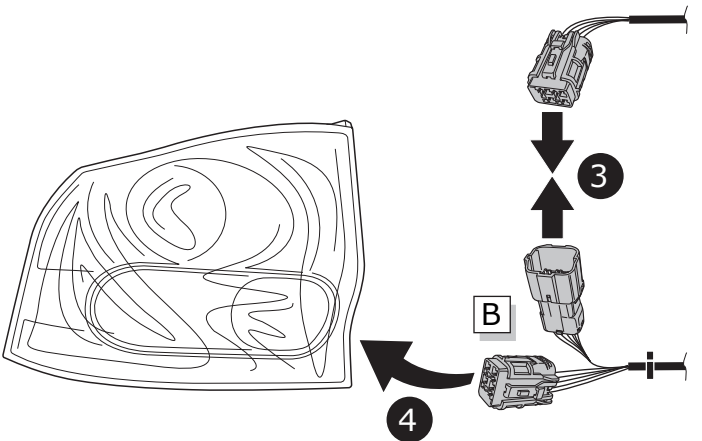
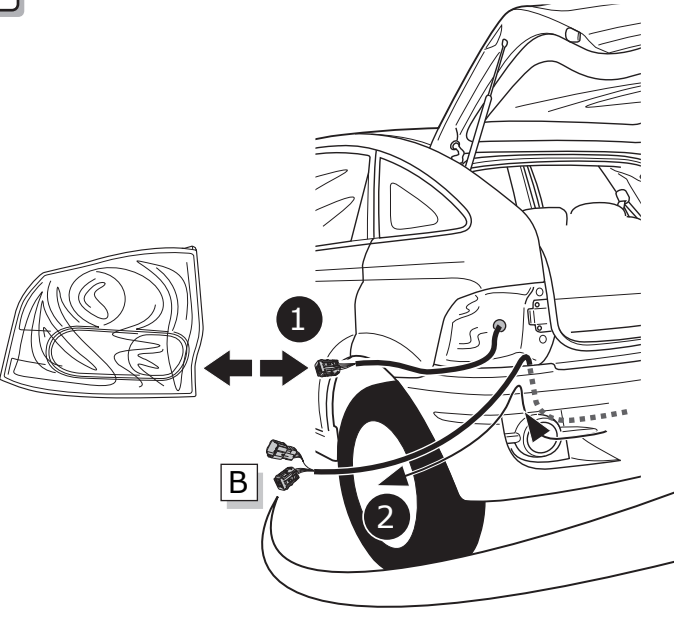

7

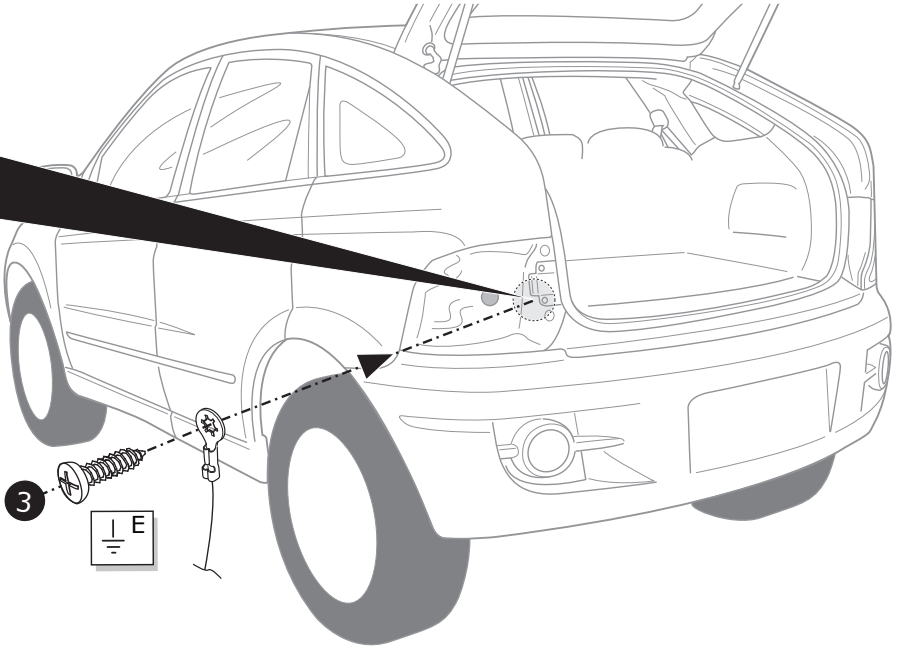
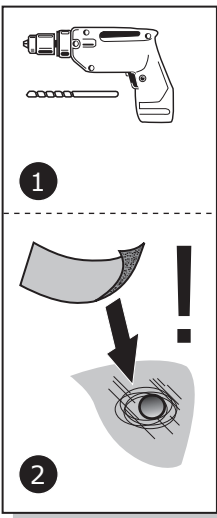

8

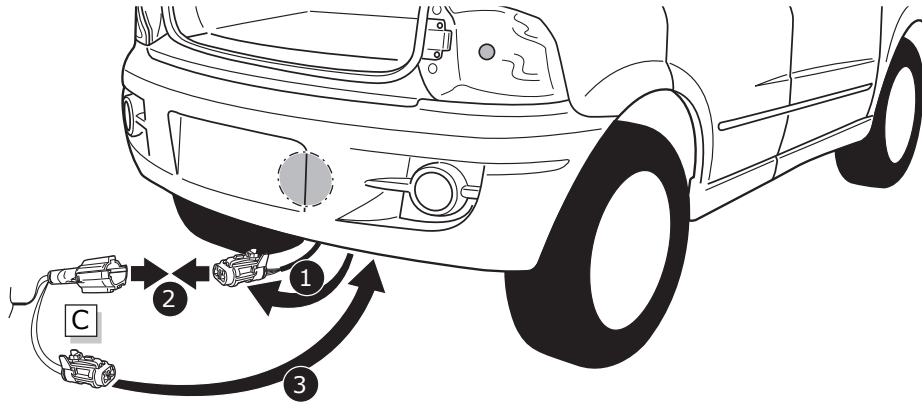

9

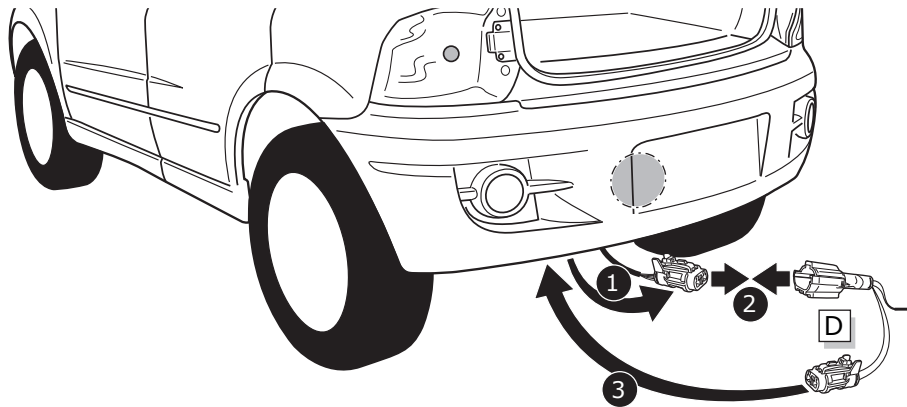

10

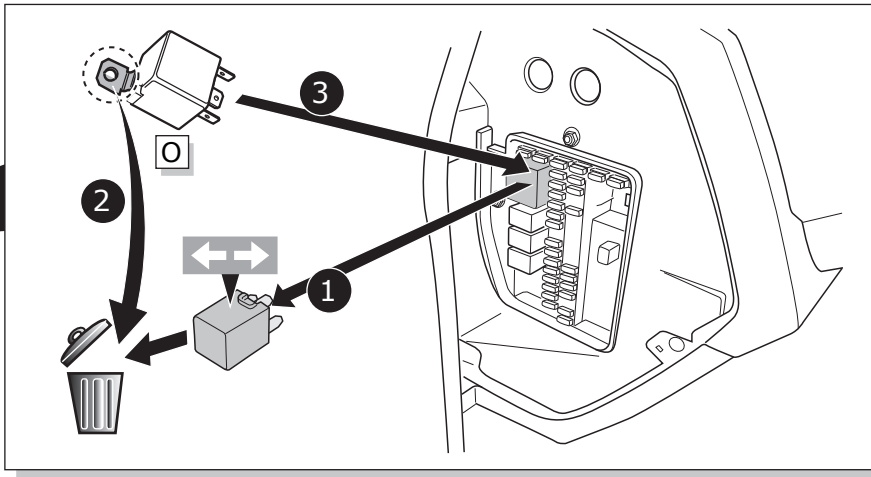
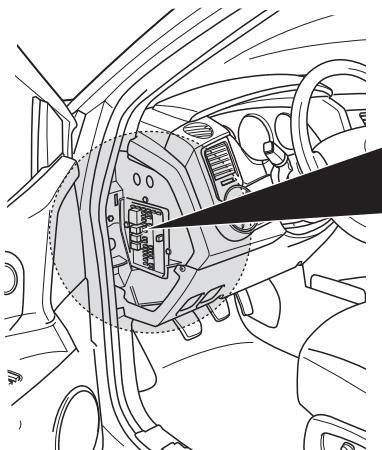

11

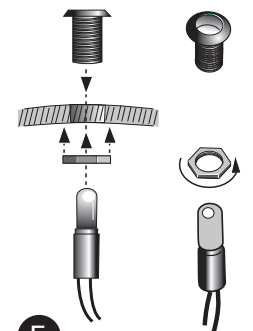
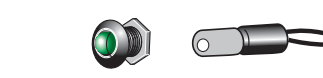
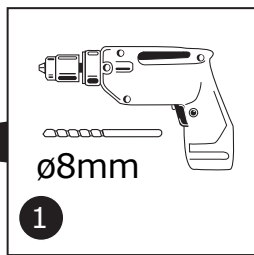
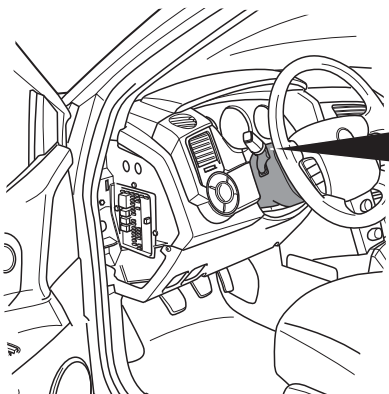

- DE Die Kontrollleuchte blinkt, wenn beim angeschlossenen Anhänger Blinker (3x21W) oder Warnblinkanlage (6x21W) eingeschaltet sind.
- FR Le deuxième témoin de contrôle clignote lorsque les feux de détresses (6x21W) et les clignotants (3x21W) du véhicule sont allumés alors que la caravane/remorque est accouplée au véhicule.
- NL Het controle-lampje knippert wanneer bij aangesloten aanhanger de knipperlichten (3x21W) of waarschuwingslichten (6x21W) ingeschakeld zijn.
- GB By switching on flashers with the trailer connected (3x21W) or the warning lights (6x21W), the 2nd direction indicator light will flash.
- ES El piloto de control parpadea si, estando el remolque acoplado, las luces de destellos (3x21W) o de emergencia (6x21W) están encendidas.
- IT La lampada di controllo lampeggia se, con il rimorchio agganciato, sono in funzione gli indicatori di direzione (3 x 21W) o le luci di pericolo (6 x 21W).
- SE Kontrolllampan blinkar om blinkljusen (3x21W) eller varningsljusen (6x21W) är inkopplade hos den påkopplade släpvagnen.
- CZ Zapnutím blikáčů za připojeného návěsu (3x12W) nebo výstražných světel (6x12W) bude blikat druhé směrové světlo.
- DK Hvis blinklysene tændes med anhængerens forbundet (3 x 21 W) eller advarselslysene (6 x 21 W), blinker den anden retningsindikator.
- FI Merkkivalo (toinen suuntavilkku) vilkkuu, mikäli autoon yhdistetyn perävaunun suuntavilkut (3x21W) tai varoitusvilkkuvalot (6x21W) ovat kytkettyjä päälle.
- GR Ανάβοντας τα τόξα πορείας με το ρυμουλκώ συνδεδεμένο (3x21W) ή τα προειδοποιητικά φώτα (6x21W), το 2ο φλας θα εκπέμψει λάμψη.
- NO Kontrolllampen blinker når blinklysene (3x21W) eller varsellampene (6x21W) står på hos den tilkoblede tilhengeren.
- PL Poprzez włączenie przerywaczy kierunkowskazów z podłączoną przyczepą (3x21W) lub świateł ostrzegawczych (6x21W) drugi wskaźnik kierunku będzie migać.

12

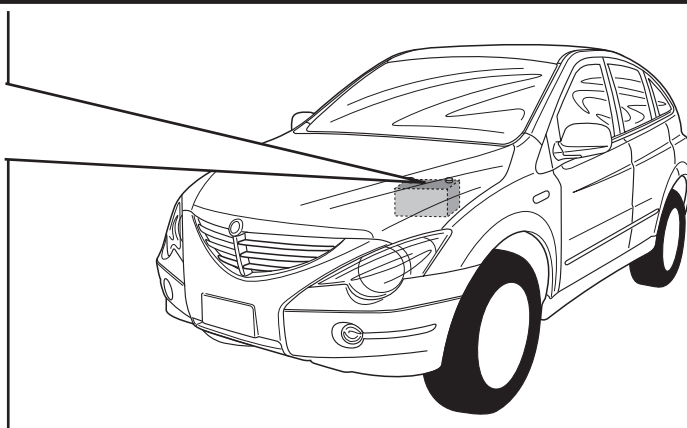
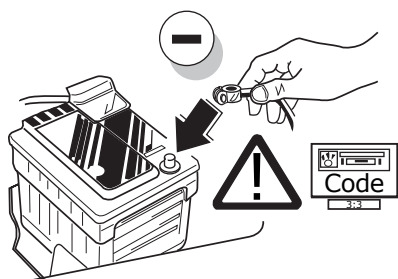

13

- | | |
|--|---|
| <ul style="list-style-type: none"> DE FUNKTIONEN KONTROLLIEREN MIT EINEM PRÜFGERÄT MIT WIDERSTAND ODER MIT LEUCHTEN MIT DER GENAUEN WATTZAHL! FR CONTRÔLER LES FONCTIONS AVEC UNE BOÎTE DE TEST AVEC DE LA CHARGE OU DES LAMPES AVEC LA QUANTITÉ CORRECTE DE WATT! NL CONTROLEER FUNCTIES MET EEN TESTER MET BELASTING OF LAMPEN MET DE JUISTE WATTAGE! GB TEST ALL CIRCUIT FUNCTIONS WITH A TESTBOX WITH THE CORRECT POWER LOAD FOR EACH UNIT. A TESTBOX ON WHICH ONLY LEDs ARE USED CAN NOT BE USED IN THIS CASE ES ¡CONTROLAR FUNCIONES CON UN TESTER CON CARGA O LUCES CON EL CORRECTO WATTAJE! IT CONTROLLA FUNZIONI CON UN TESTER CON CARICO O LAMPADE DEL GIUSTO WATT-TAGGIO! | <ul style="list-style-type: none"> SE KONTROLLERA FUNKTIONERNA MED EN TESTARE MED BELASTNING ELLER LAMPOR MED RÄTT WATT-VÄRDE! CZ OVĚŘTE FUNKCE POMOČÍ TESTOVACÍHO BOXU NEBO SVĚTEL S PŘÍSLUŠNÝM VÝKONEM! DK CHECK FUNKTIONERNE MED EN TESTBOKS, MED BELASTNING ELLER MED LYGTTER MED DET KORREKTE ANTAL WATT! FI TARKISTA TOIMINNOT KÄYTTÄMÄLLÄ TESTILAITE, JOSSA ON OIKEATEHOINEN KUORMITUS TAI OIKEATEHOISET LAMPUT! GR ΕΛΕΓΞΤΕ ΤΙΣ ΛΕΙΤΟΥΡΓΙΕΣ ΜΕ ΉΝΑ ΚΙΒΩΤΙΟ ΔΟΚΙΜΗΣ ΜΕ ΦΟΡΤΙΟ Ή ΛΑΜΠΤΗΡΕΣ ΣΩΣΤΗΣ ΠΟΣΟΤΗΤΑΣ ΒΑΤ! NO KONTROLER FUNKSJONENE MED EN TESTER MED BELASTNING ELLER LYSFÆRER MED RIKTIG WATTVERDI! PL SPRAWDŹ FUNKCJE UŻYWAJĄC SKRZYŃKI TESTOWEJ Z OBCIĄŻENIEM LUB PODŁĄCZONYMI ŻARÓWKAMI O ODPOWIEDNIEJ MOCY! |
|--|---|

14

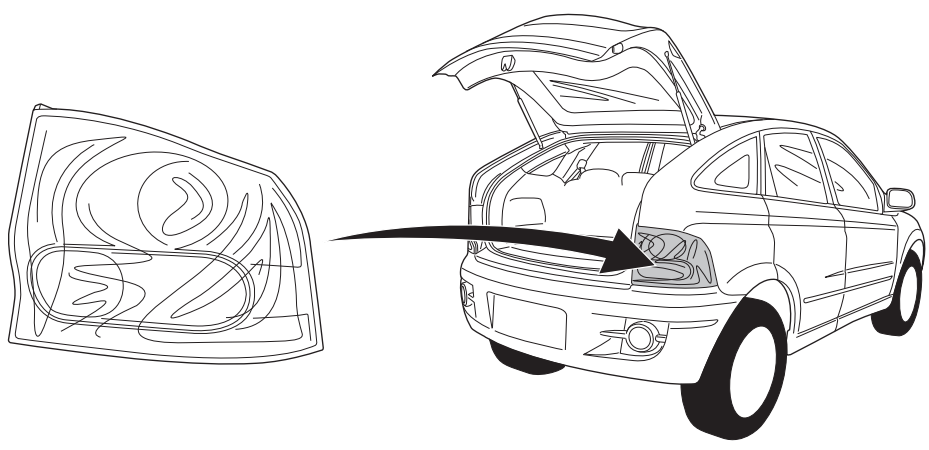

15

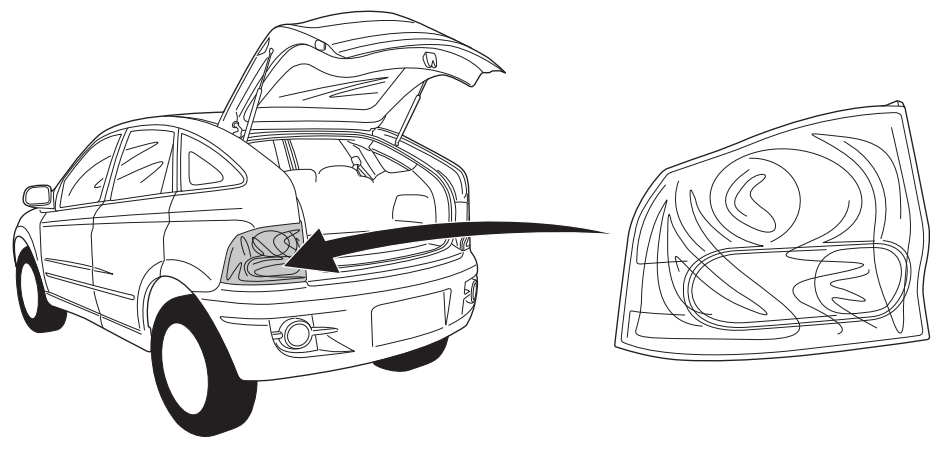

16

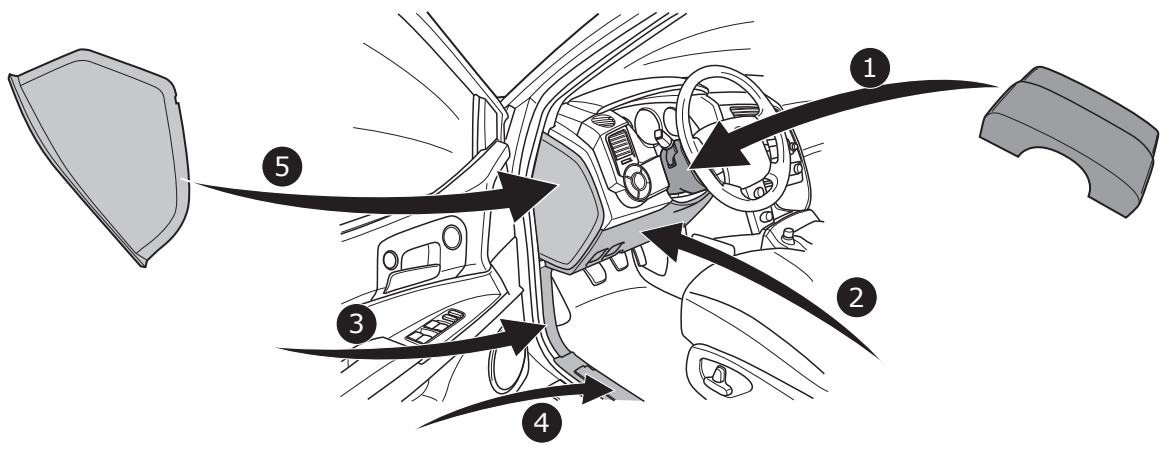





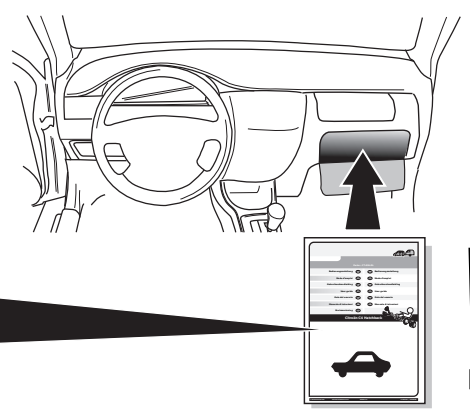



17

- Ⓛ DE Gebrauchsanleitung.
- Ⓛ FR Mode d'emploi.
- Ⓛ NL Gebruikershandleiding.
- Ⓛ GB User guide.
- Ⓛ ES Guía del usuario.
- Ⓛ IT Manuale di istruzioni.
- Ⓛ SE Bruksanvisning.
- Ⓛ CZ Uživatelská příručka.
- Ⓛ DK Brugervejledning.
- Ⓛ FI Käyttöohjeet.
- Ⓛ GR Οδηγός χρήστη.
- Ⓛ NO Brukerveiledning.
- Ⓛ PL Instrukcja obsługi.



INFO

- | | |
|--|------------------------------------|
| DE Anschluss Steckdose | CZ Objímkový konektor |
| FR Connection de la prise | DK Stikdåse forbindelse |
| NL Contactdoos aansluiting | FI Pistorasia liitäntä |
| GB Socket connection | GR Υποδοχή σύνδεσης |
| ES Conexión de la caja de enchufe | NO Tilkobling koblingsboks |
| IT Allaccio zoccolo | PL Połączenie przez gniazdo |
| SE Anslutning kontaktdosa | |

DIN/ISO 1724								
	1/L	2	3/31	4/R	5/58-R	6/54	7/58-L	8
Pmax	21W	2x21W		21W	52W	3x21W	52W	
DE	Gelb	Blau	Weiß	Grün	Braun	Rot	Schwarz	Grau
FR	Jaune	Bleu	Blanc	Vert	Marron	Rouge	Noir	Gris
NL	Geel	Blauw	Wit	Groen	Bruin	Rood	Zwart	Grijs
GB	Yellow	Blue	White	Green	Brown	Red	Black	Grey
ES	Amarillo	Azul	Blanco	Verde	Marrón	Rojo	Negro	Gris
IT	Giallo	Blu	Bianco	Verde	Marrone	Rosso	Nero	Grigio
SE	Gul	Blå	Vit	Grön	Brun	Röd	Svart	Grå
CZ	Žlutá	Modrá	Bílá	Zelená	Hnědá	Červená	Černá	Šedá
DK	Gul	Blå	Hvid	Grøn	Brun	Rød	Sort	Grå
FI	Keltainen	Sininen	Valkoinen	Vihreä	Ruskea	Punainen	Musta	Harmaa
GR	Κίτρινο	Μπλε	Λευκό	Πράσινο	Καφέ	Κόκκινο	Μαύρο	Γκρι
NO	Gul	Blå	Hvit	Grønn	Brun	Rød	Svart	Grå
PL	Żółty	Niebieski	Biały	Zielony	Brązowy	Czerwony	Czarny	Szary