

4

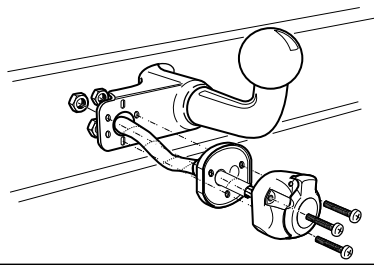

Anschluß Steckdose / Connection de la prise / Socket connection / Contactdoos aansluiting

DIN/ISO 1724		D	F	GB	NL	Pmax
	1/L	gelb	jaune	yellow	geel	21W
	2	blau	bleu	blue	blauw	2x21W
	3/31	weiß	blanc	white	wit	
	4/R	grün	vert	green	groen	21W
	5/58-R	braun	marron	brown	bruin	52W
	6/54	rot	rouge	red	rood	3x21W
	7/58-L	schwarz	noir	black	zwart	52W
	8/54b	grau	gris	grey	grijs	

PEUGEOT 307 BREAK / SW 2002- Nr.: PE-012-BB

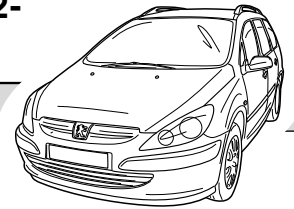

* Teilliste * Liste de pieces * Part list * Onderdelenlijst

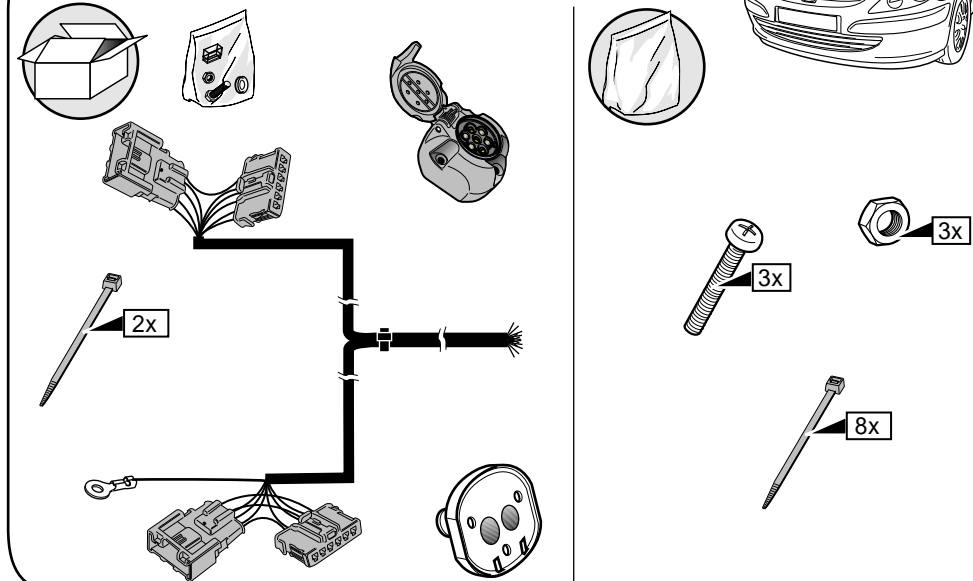

D Einbauanleitung Elektrosatz
Anhängervorrichtung mit 12-N Steckdose
lt. DIN/ISO Norm 1724

GB Fitting instructions electric wiringkit
towbar with 12-N socket up to
DIN/ISO norm 1724

F Instructions de montage du faisceau
électrique pour crochet d'attelage
conforme à la norme
DIN/ISO 1724 prise 12-N

NL Montage-handleiding elektrokabelset
voor trekhaak met 12-N contactdoos
vlg. DIN/ISO norm 1724

5

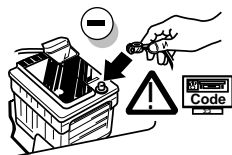

6

D FUNKTIONEN KONTROLLIEREN !

F CONTRÔLER LES FONCTIONS !

GB CHECK FUNCTIONS !

NL CONTROLEER FUNCTIES !

7

D Teile zurückmontieren.

F Montez les part enlèves.

GB Reinstall linings.

NL Onderdelen terug plaatsen.



D

- Wir weisen ausdrücklich darauf hin, das eine unsachgemäße und nicht in einer Fachwerkstätte durchgeführte Montage einen Verzicht auf die Geltendmachung jeglicher Art insbesondere auch aus dem Titel des Produkthaftpflichtrechtes bewirkt.
- Technische Änderungen vorbehalten.
- Belastung nur tabellgemäß auf dem anhängen verwenden, siehe Seite 4.

F

- Il est expressement prévu qu' on ne saurait se prévaloir d'un quelconque préjudice contractuel ou réhibitoire si le montage avait été fait en dépit des dites instructions ou dans un garage ne disposant pas des équipements adéquats.
- Sous réserve de modifications techniques.
- Ne excédez pas la charge maximale, indiquée dans le tableau sur page 4.

GB

- We would expressly point out that any improper assembly which is not carried out in a specialist workshop will result in the renunciation of the enforcement of compensation claims of any kind, in particular those arising by virtue of the product liability law.
- Subject to alteration without notice.
- Only use maximum charge according to connectiontable on towed vehicle, see page 4.

NL

- Wij wijzen er met nadruk op, dat ondeskundige en niet door een vakkundige werkplaats uitgevoerde montage tot gevolg heeft dat daardoor ieder recht op schadevergoeding, ook op wettelijke aansprakelijkheid inzake producten, vervalt.
- Technische wijzigingen voorbehouden.
- Gebruik alleen belasting volgens aansluittabel op het getrokken voertuig, zie pagina 4.

1

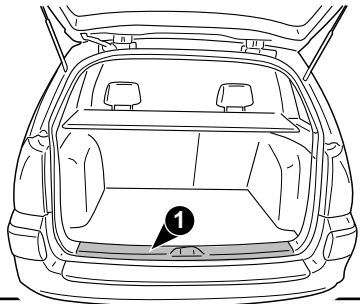
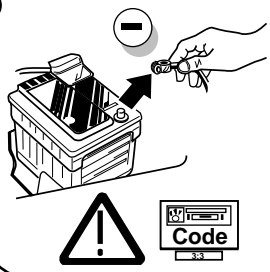

D

Abmontieren Teile

F

Démontez les parts

GB

Remove linings

NL

Verwijder onderdelen

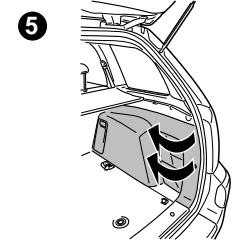
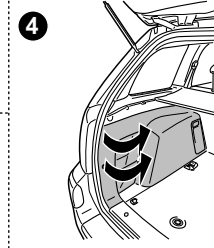
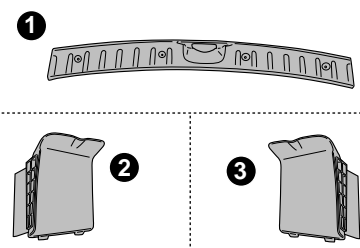
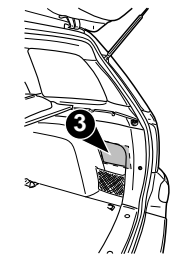
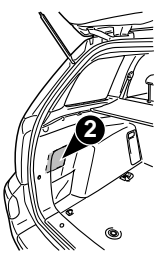

INFO

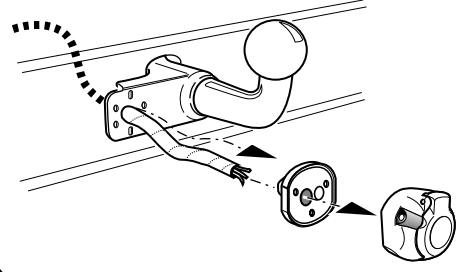
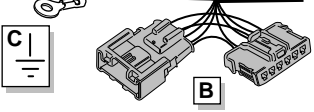
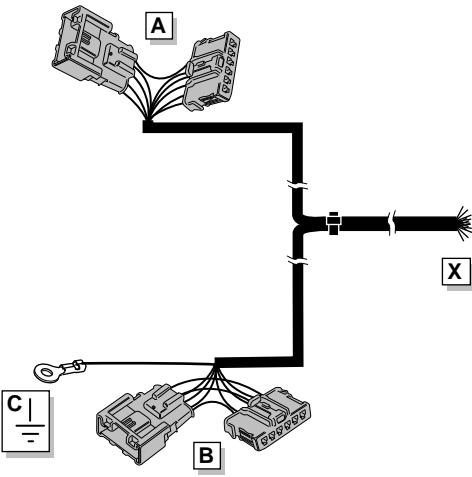

2

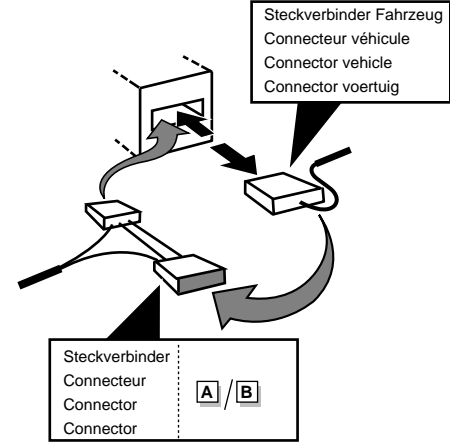

ROUTING

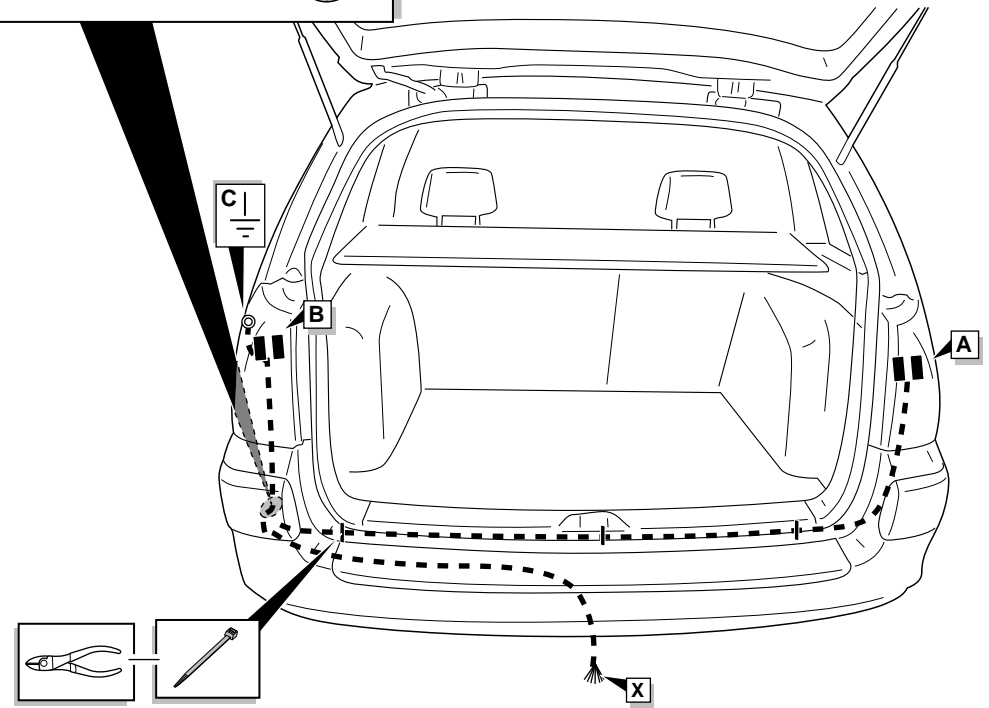
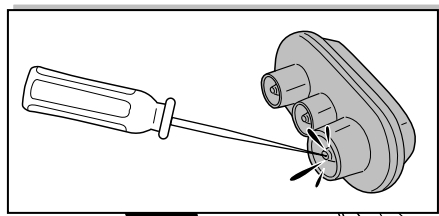

3

