

**Einbauanleitung Elektrosatz
Anhängervorrichtung mit 12-N Steckdose
lt. DIN/ISO Norm 1724**

**Instructions de montage du faisceau
électrique pour crochet d'attelage
conforme à la norme
DIN/ISO 1724 prise 12-N**

**Fitting instructions electric wiringkit
towbar with 12-N socket up to
DIN/ISO norm 1724**

**Montage-handleiding elektrokabelset voor
trekhaak met 12-N contactdoos
vlg. DIN/ISO norm 1724**

**Instrucciones de montaje de juego de cables
eléctricos para gancho de remolque con caja de
conexiones 12-N según norma DIN/ISO 1724**

**Istruzioni di montaggio di set di cavi elettrici per
gancio da traino con zoccolo a 12-N conforme alla
norma DIN/ISO 1724**

**Monteringsanvisningar elkabelsats för dragkrok
med 12-N kontaktdosa enligt DIN/ISO norm 1724**

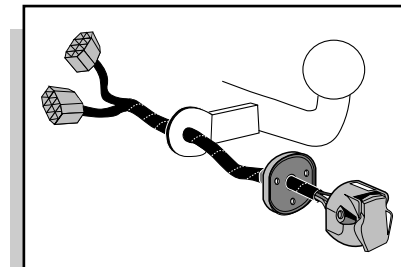

MITSUBISHI COLT 3 Drs. 2004-

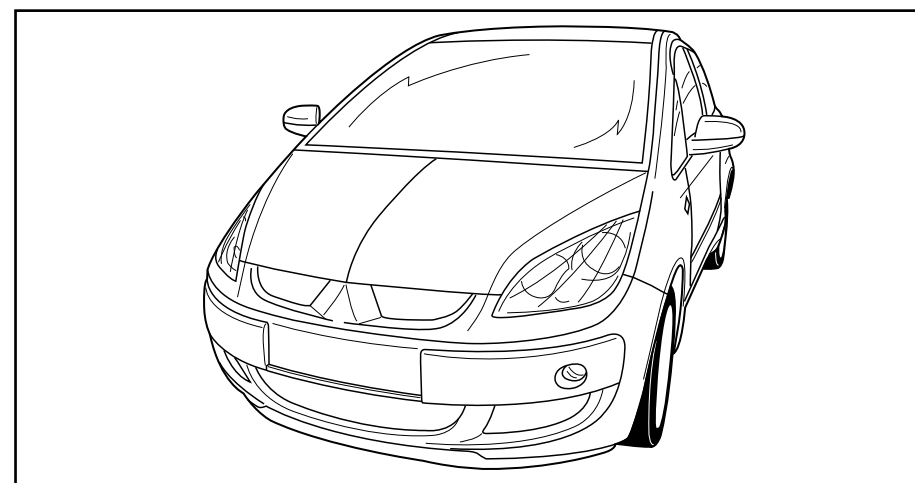

Bestel Nr.: MT-059-BB

*Teilliste *Liste de pieces *Part list *Onderdelenlijst
*Lista de componentes *Elenco componenti *Dellista

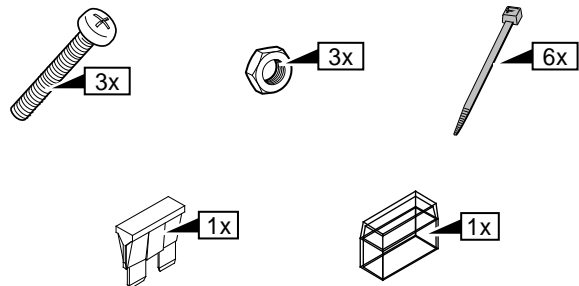
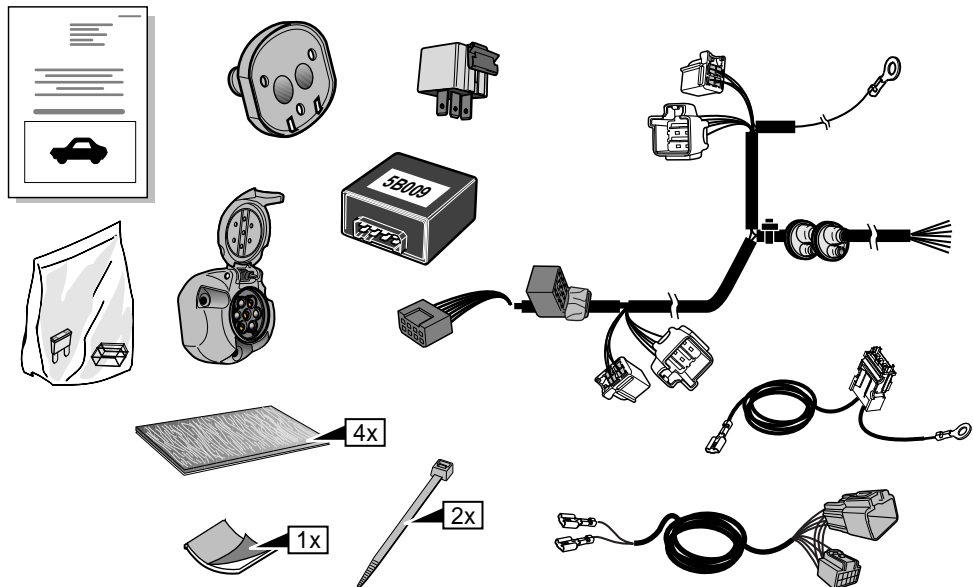
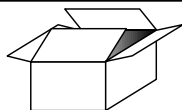

INFO

- Wir weisen ausdrücklich darauf hin, dass eine unsachgemäße und nicht in einer Fachwerkstätte durchgeführte Montage einen Verzicht auf die Geltendmachung jeglicher Art insbesondere auch aus dem Titel des Produkthaftpflichtrechtes bewirkt.
- Technische Änderungen vorbehalten.
- Belastung nur tabellgemäß auf dem Anhänger verwenden, siehe Seite 3.

DU

- Il est expressément prévu qu' on ne saurait se prévaloir d'un quelconque préjudice contractuel ou rédhitoire si le montage avait été fait en dépit des dites instructions ou dans un garage ne disposant pas des équipements adéquats.
- Sous réserve de modifications techniques.
- Ne excédez pas la charge maximale, indiquée dans le tableau sur page 3.

FR

- We would expressly point out that any improper assembly which is not carried out in a specialist workshop will result in the renunciation of the enforcement of compensation claims of any kind, in particular those arising by virtue of the product liability law.
- Subject to alteration without notice.
- Only use maximum charge according to connectiontable on towed vehicle, see page 3.

GB

- Wij wijzen er met nadruk op, dat ondeskundige en niet door een vakkundige werkplaats uitgevoerde montage tot gevolg heeft dat daardoor ieder recht op schadevergoeding, ook op wettelijke aansprakelijkheid inzake producten, vervalt.
- Technische wijzigingen voorbehouden.
- Gebruik alleen belasting volgens aansluittabel op het getrokken voertuig, zie pagina 3.

NL

- El montaje inapropiado y efectuado por personal no cualificado originará la pérdida de todo derecho a indemnización o la expiración de toda responsabilidad civil con respecto al producto.
- Nos reservamos el derecho a efectuar modificaciones técnicas.
- Utilice sólo cargas de acuerdo a la tabla de conexión del vehículo remolcado (ver página 3).

ES

- Sottolineiamo espressamente che un montaggio inadeguato ed eseguito da un'officina non specializzata ha come conseguenza il decadere di qualsiasi diritto al risarcimento danni, nonché alla responsabilità legale relativa ai prodotti.
- Ci si riserva il diritto di apportare modifiche tecniche.
- Utilizzare esclusivamente un carico conforme alla tabella degli allacci relativa al veicolo in questione, cfr. pagina 3.

IT

- Vi påpekar med eftertryck att all rätt till skadeersättning och all laglig ansvarighet förfaller om monteringen inte har utförts på rätt sätt och av en professionell verkstad.
- Tekniska ändringar förbehålles.
- Använd endast belastning enligt anslutningstabellen på det dragna fordonet, se sid. 3.

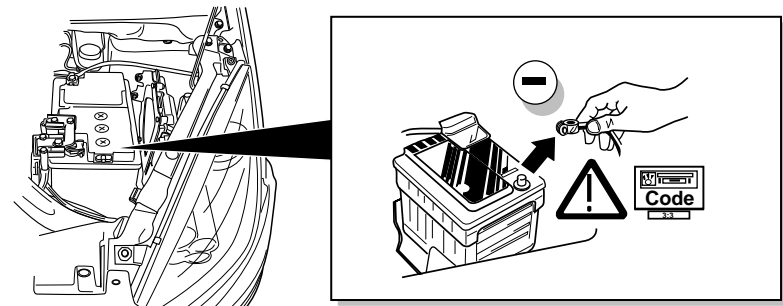
SE**1**

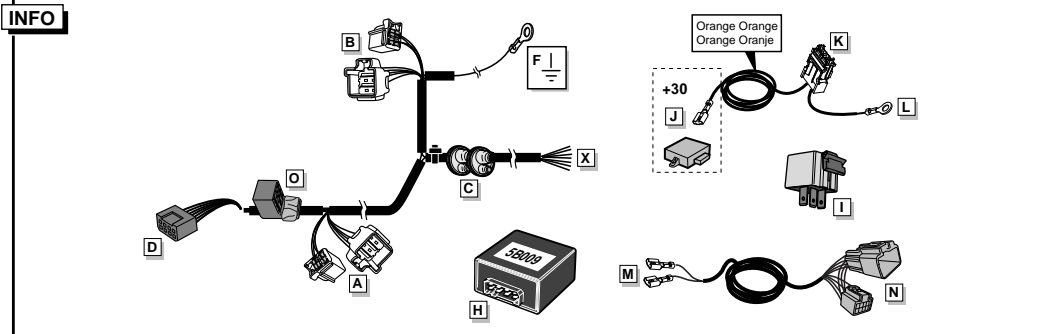
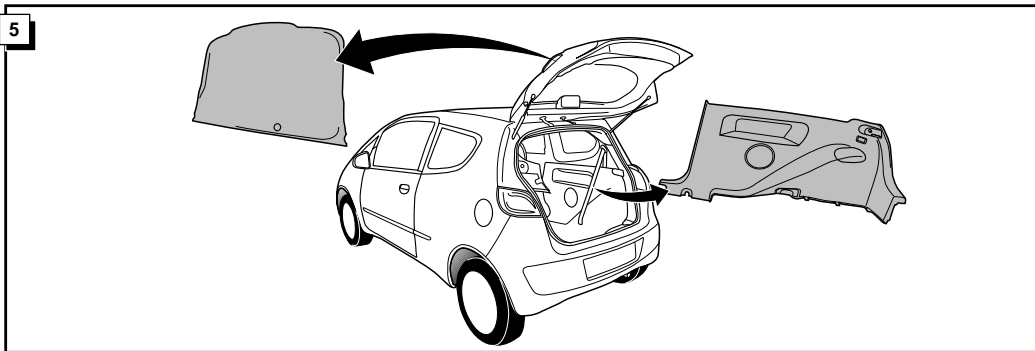
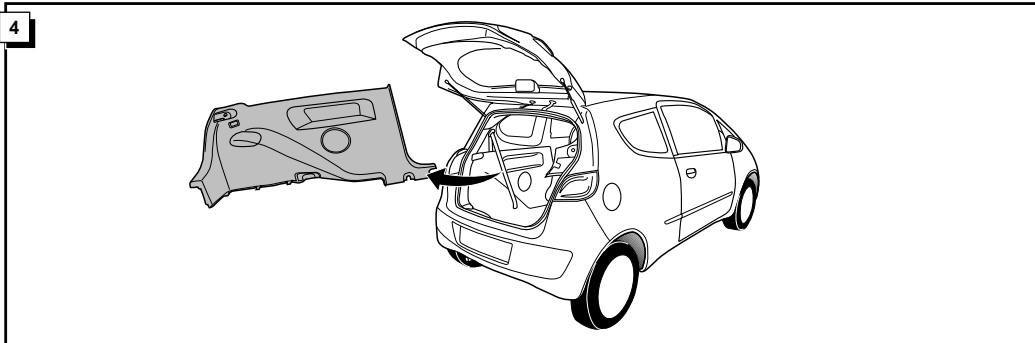
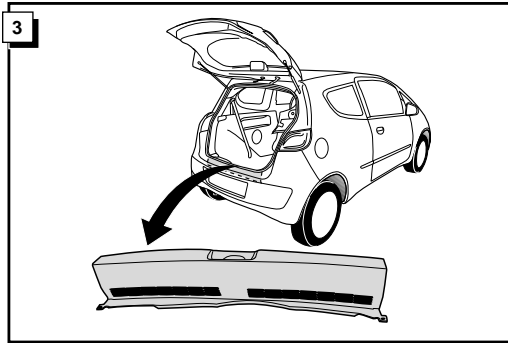
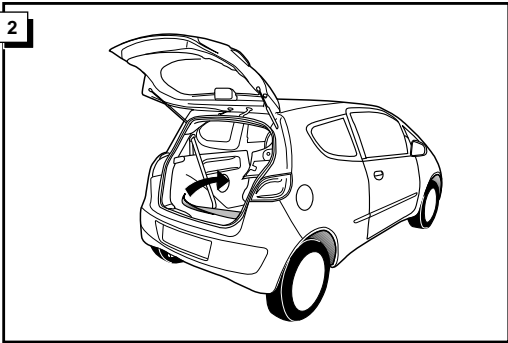

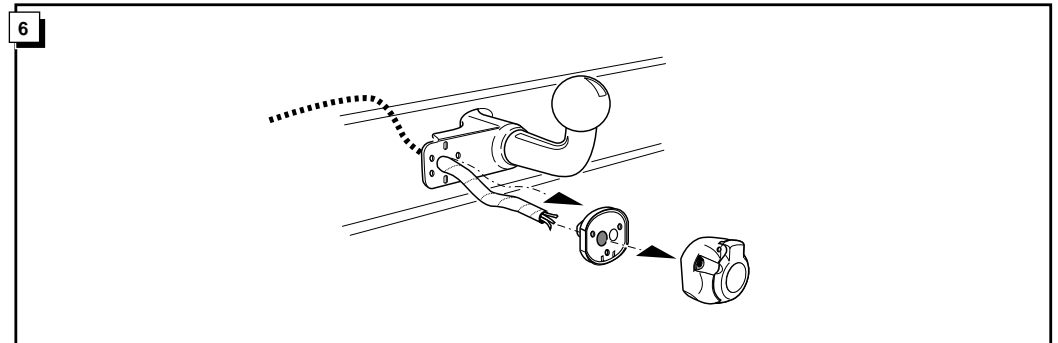
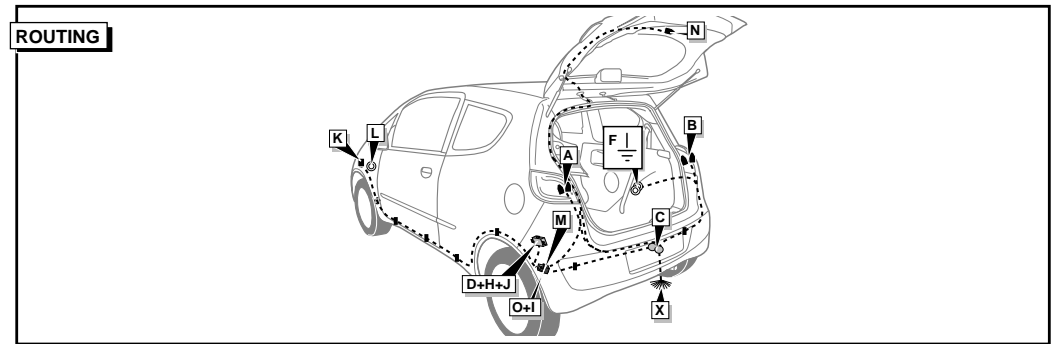
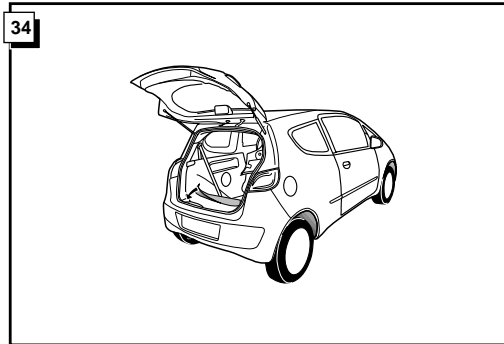
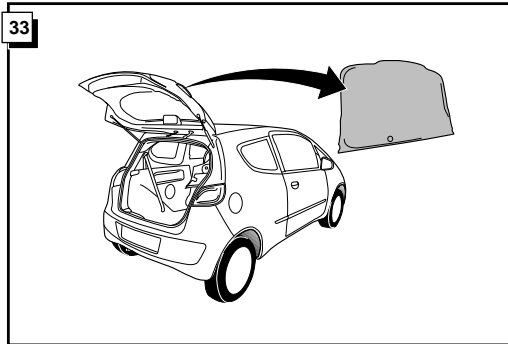

INFO

Anschluß Steckdose / Connection de la prise / Socket connection / Contactdoos aansluiting
 Conexiones del enchufe / Allaccio zoccolo / Anslutning kontaktdosa

INFO									
DIN/ISO 1724		DE	FR	GB	NL	ES	IT	SE	P _{max}
	1/L	gelb	jaune	yellow	geel	amarillo	giallo	gul	21W
	2	blau	bleu	blue	blauw	azul	blu	blå	2x21W
	3/31	weiß	blanc	white	wit	blanco	bianco	vit	
	4/R	grün	vert	green	groen	verde	verde	grön	21W
	5/58-R	braun	marron	brown	bruin	marrón	marrone	brun	52W
	6/54	rot	rouge	red	rood	rojo	rosso	röd	3x21W
	7/58-L	schwarz	noir	black	zwart	negro	nero	svart	52W
	8/58-bL								

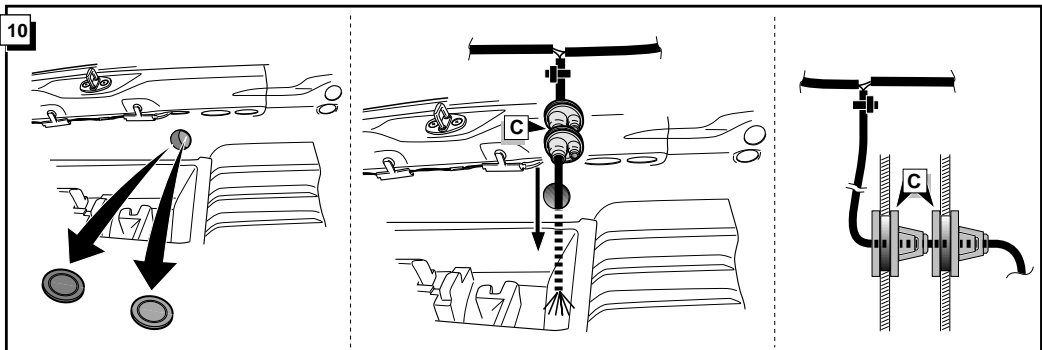
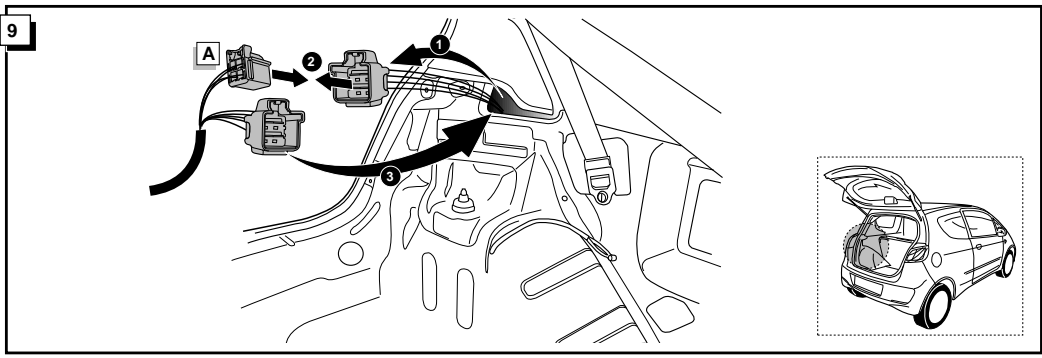
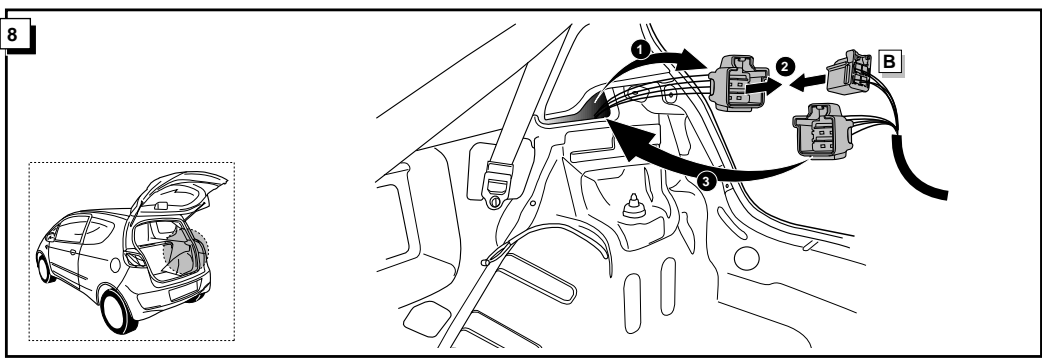
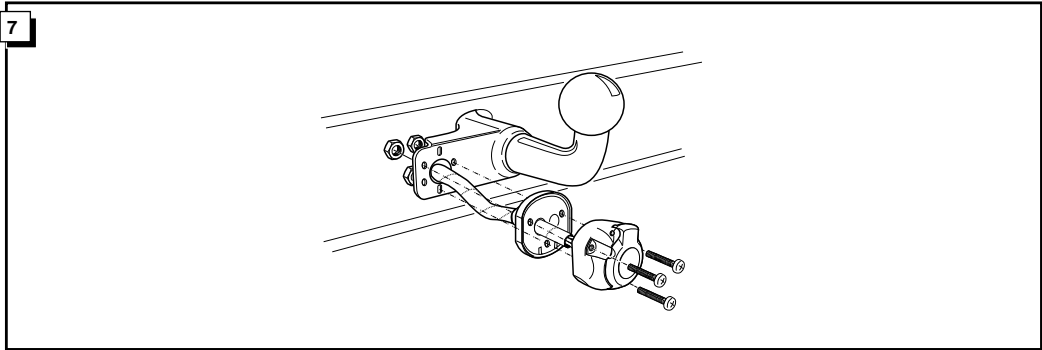

26

FUNKTIONEN KONTROLLIEREN MIT EINEN TESTKASTEN MIT BELASTUNG ODER MIT LEUCHTEN MIT DER GENAUEN MENGE DES WATTS !

! CONTRÔLER LES FONCTIONS AVEC UNE BOÎTE DE TEST AVEC DE LA CHARGE OU DES LAMPES AVEC LA QUANTITÉ CORRECTE DE WATT !

CHECK FUNCTIONS WITH A TESTBOX WITH LOAD OR LAMPS WITH THE RIGHT AMOUNT OF WATT !

CONTROLEER FUNCTIES MET EEN TESTER MET BELASTING OF LAMPEN MET DE JUISTE WATTAGE !

¡CONTROLAR FUNCIONES CON UN TESTER CON CARGA O LUCES CON EL CORRECTO VOLTAJE!

CONTROLLA FUNZIONI CON UN TESTER CON CARICO O LAMPADE DEL GIUSTO VOLTAGGIO!

KONTROLLERA FUNKTIONERNA MED EN TESTARE MED BELASTNING ELLER LAMPOR MED RÄTT WATT-VÄRDE!

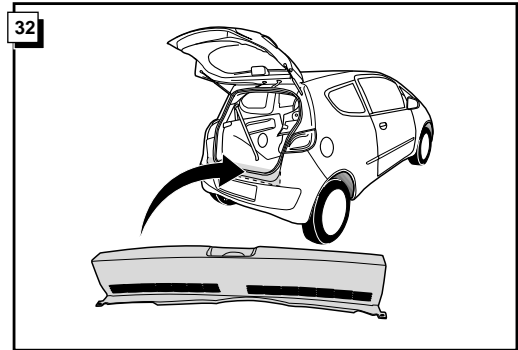
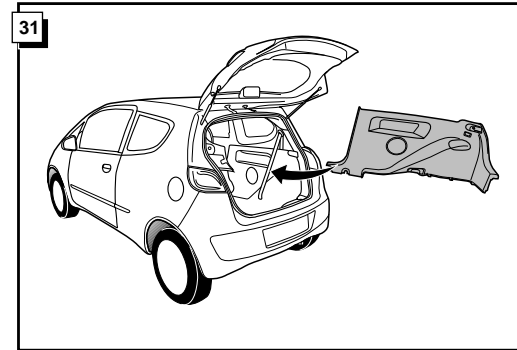
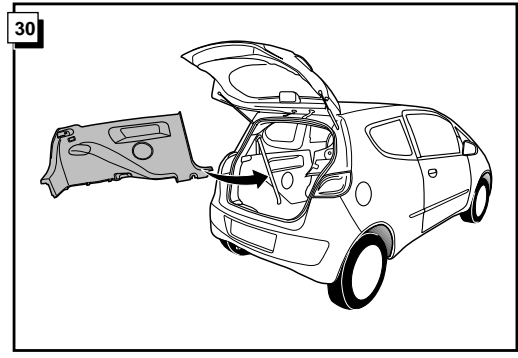
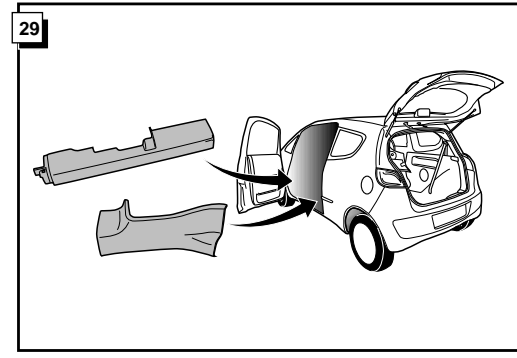
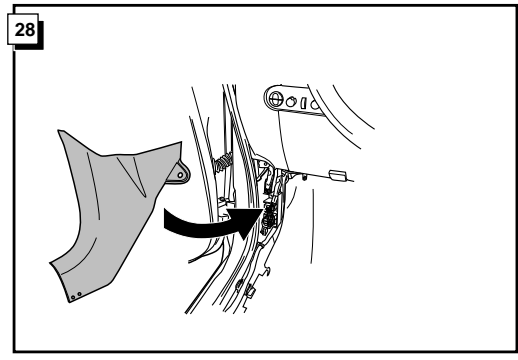
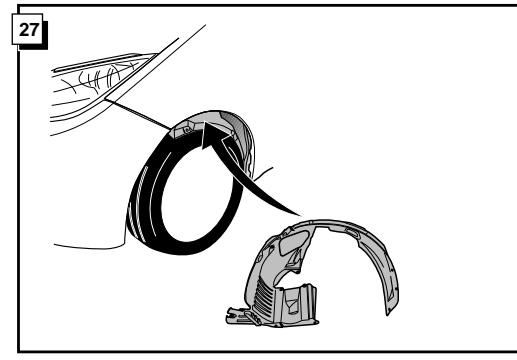

22

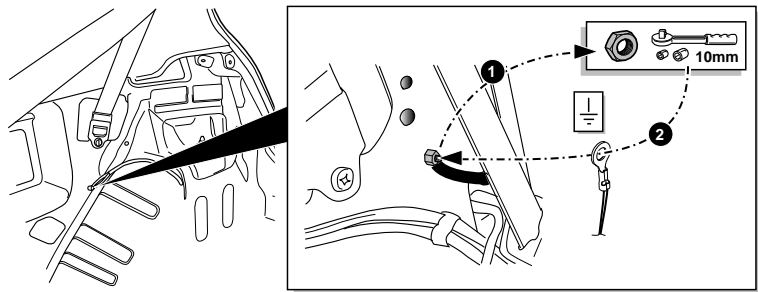

11

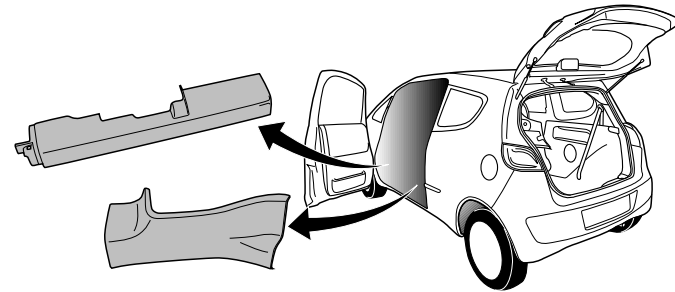

23

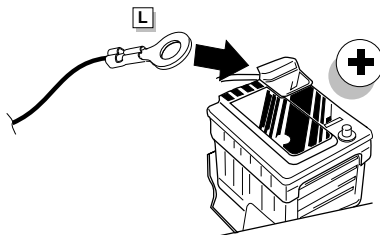

12

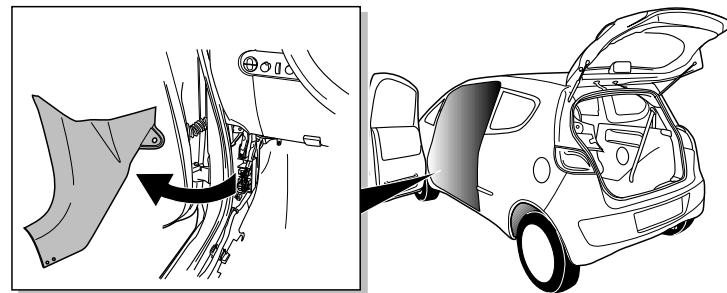

24

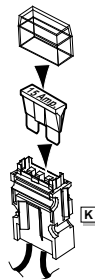

13

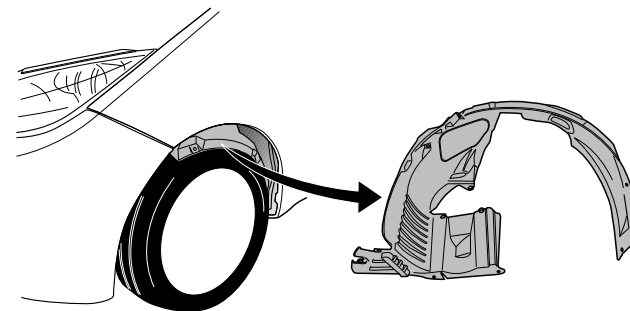

25

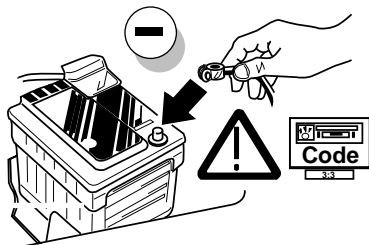

14

