

Einbauanleitung Elektrosatz  
Anhängervorrichtung mit 12-N Steckdose  
lt. DIN/ISO Norm 1724

LN-005-BL

131204RS

Instructions de montage du faisceau  
électrique pour crochet d'attelage  
conforme à la norme  
DIN/ISO 1724 prise 12-N

Fitting instructions electric wiringkit  
towbar with 12-N socket up to  
DIN/ISO norm 1724

Montage-handleiding elektrokabelset voor  
trekhaak met 12-N contactdoos  
vlg. DIN/ISO norm 1724

Instrucciones de montaje de kit eléctrico para  
enganche de remolque con caja de conexiones  
12-N según norma DIN/ISO 1724

Istruzioni di montaggio di set di cavi elettrici per  
gancio da traino con zoccolo a 12-N conforme alla  
norma DIN/ISO 1724

Monteringsanvisningar elkabelsats för dragkrok  
med 12-N kontaktdosa enligt DIN/ISO norm 1724

Instrukcje montażu zestawu okablowania  
elektrycznego dyszla holowniczego z 12-N  
stykowym gniazdem DIN/ISO 1724

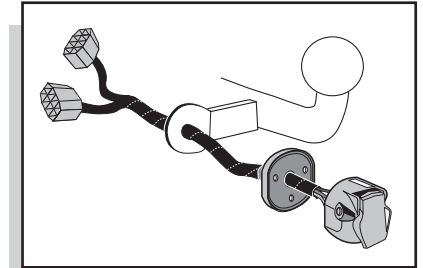

**Lancia Musa 11/2004 - 12/2007**

**Fiat IDEA 12/2003 - 07/2007**

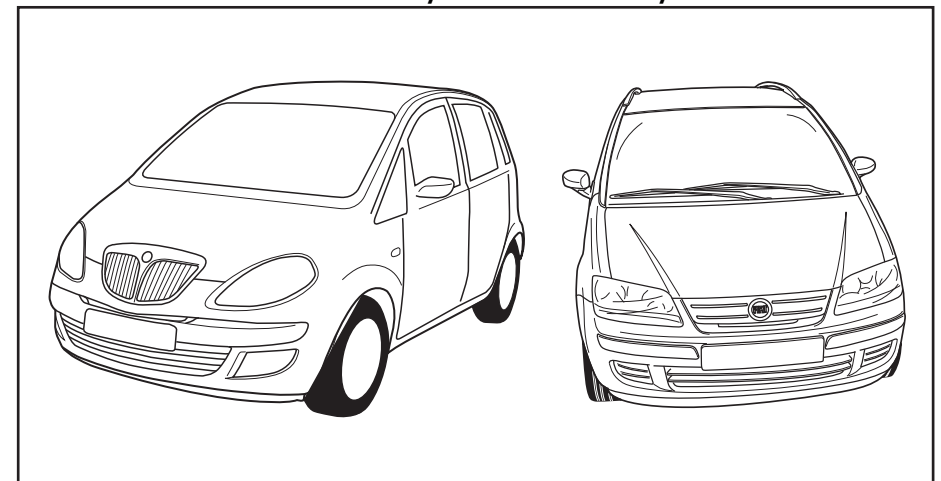

**Bestel Nr.: LN-005-BL**

\*Einzelteilliste \*Liste de pieces \*Part list \*Onderdelenlijst  
 \*Lista de componentes \*Elenco componenti \*Dellista \*Lista części

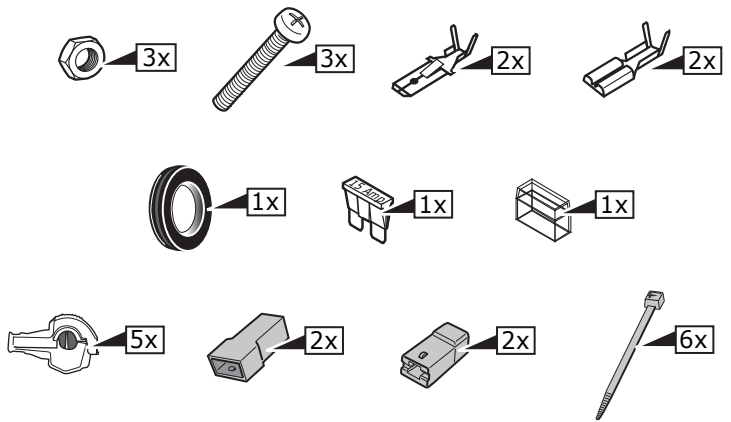
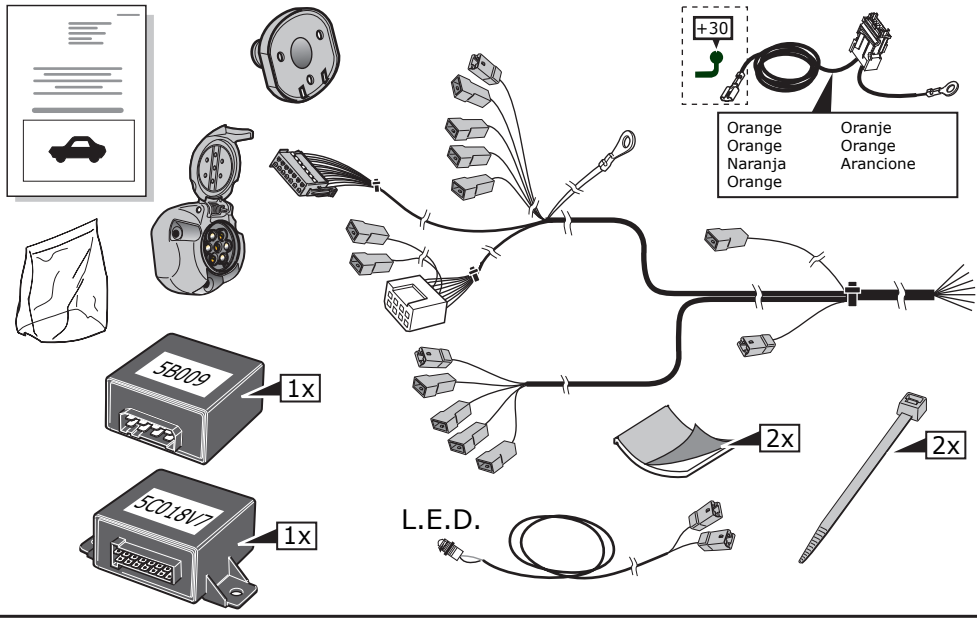
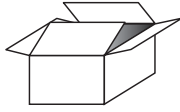

17

- DE FUNKTIONEN KONTROLLIEREN !
- FR CONTRÔLER LES FONCTIONS !
- GB CHECK FUNCTIONS !
- NL CONTROLEER FUNCTIES !
- ES ¡ CONTROLAR FUNCIONES !
- IT CONTROLLA FUNZIONI !
- SE KONTROLLERA FUNKTIONERNA !

18

Die Kontrolleuchte blinkt, wenn beim angeschlossenen Anhänger die Blinker (3x21W) oder Warnblinkanlage (6x21W) eingeschaltet sind.

El piloto de control parpadea si, estando el remolque acoplado, las luces de destellos (3x21W) o de emergencia (6x21W) están encendidas.

Le deuxième témoin de contrôle clignote lorsque les feux de détresses (6X21W) et les clignotants (3X21W) du véhicule sont allumés alors que la caravane/remorque est accouplée au véhicule.

La lampada di controllo lampeggia se, con il rimorchio agganciato, sono in funzione gli indicatori di direzione (3 x 21W) o le luci di pericolo (6 x 21W).

By switching on flashers with the trailer connected (3x21W) or the warning lights (6x21W), the 2nd direction indicator light will flash.

Kontrolllampan blinkar om blinkljusen (3x21W) eller varningsljusen (6x21W) är inkopplade hos den påkopplade släpvagnen.

Het controle-lampje knippert wanneer bij aangesloten aanhanger de knipperlichten (3x21W) of waarschuwingslichten (6x21W) ingeschakeld zijn.

19

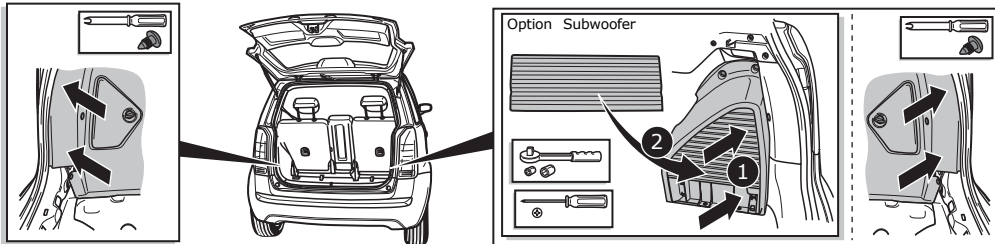

20

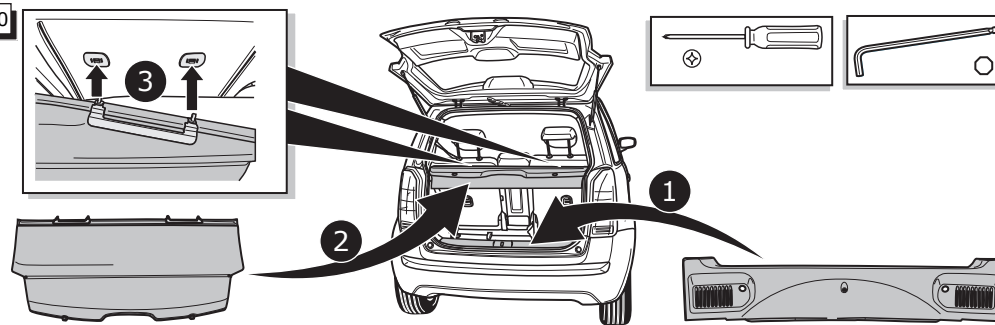

INFO

- Wir weisen ausdrücklich darauf hin, dass eine unsachgemäße und nicht in einer Fachwerkstätte durchgeführte Montage einen Verzicht auf die Geltendmachung jeglicher Art insbesondere auch aus dem Titel des Produkthaftpflichtrechtes bewirkt.

DU

- Technische Änderungen vorbehalten.  
- Belastung nur tabellgemäß auf dem anhängen verwenden, siehe Seite 4.

- Il est expressement prévu qu' on ne saurait se prévaloir d'un quelconque préjudice contractuel ou réhibitoire si le montage avait été fait en dépit des dites instructions ou dans un garage ne disposant pas des équipements adéquats.

FR

- Sous réserve de modifications techniques.  
- Ne excédez pas la charge maximale, indiquée dans le tableau sur page 4.

- We would expressly point out that any improper assembly which is not carried out in a specialist workshop will result in the renunciation of the enforcement of compensation claims of any kind, in particular those arising by virtue of the product liability law.

GB

- Subject to alteration without notice.  
- Only use maximum charge according to connectiontable on towed vehicle, see page 4.

- Wij wijzen er met nadruk op, dat ondeskundige en niet door een vakkundige werkplaats uitgevoerde montage tot gevolg heeft dat daardoor ieder recht op schadevergoeding, ook op wettelijke aansprakelijkheid inzake producten, vervalt.

NL

- Technische wijzigingen voorbehouden.  
- Gebruik alleen belasting volgens aansluittabel op het getrokken voertuig, zie pagina 4.

- El montaje inapropiado y efectuado por personal no cualificado originará la pérdida de todo derecho a indemnización o la expiración de toda responsabilidad civil con respecto al producto.

ES

- Nos reservamos el derecho a efectuar modificaciones técnicas.  
- Utilice sólo cargas de acuerdo a la tabla de conexión del vehículo remolcado (ver página 4).

- Sottolineiamo espressamente che un montaggio inadeguato ed eseguito da un'officina non specializzata ha come conseguenza il decadere di qualsiasi diritto al risarcimento danni, nonché alla responsabilità legale relativa ai prodotti.

IT

- Ci si riserva il diritto di apportare modifiche tecniche.  
- Utilizzare esclusivamente un carico conforme alla tabella degli allacci relativa al veicolo in questione, cfr. pagina 4.

- Vi påpekar med eftertryck att all rätt till skadeersättning och all laglig ansvarighet förfaller om monteringen inte har utförts på rätt sätt och av en professionell verkstad.

SE

- Tekniska ändringar förbehålles.  
- Använd endast belastning enligt anslutningstabellen på det dragna fordonet, se sid. 4.

1

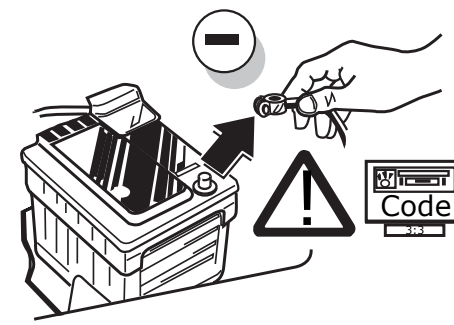

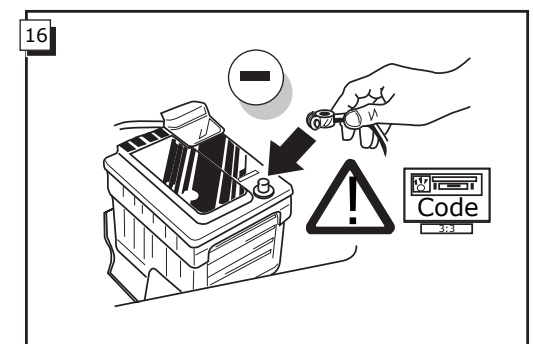
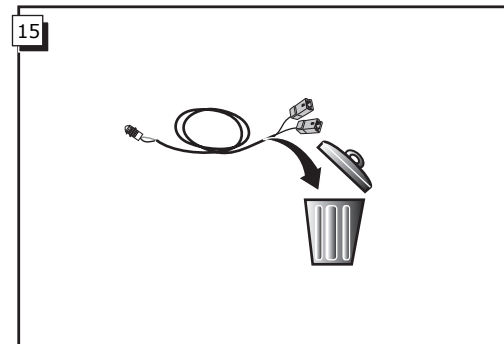
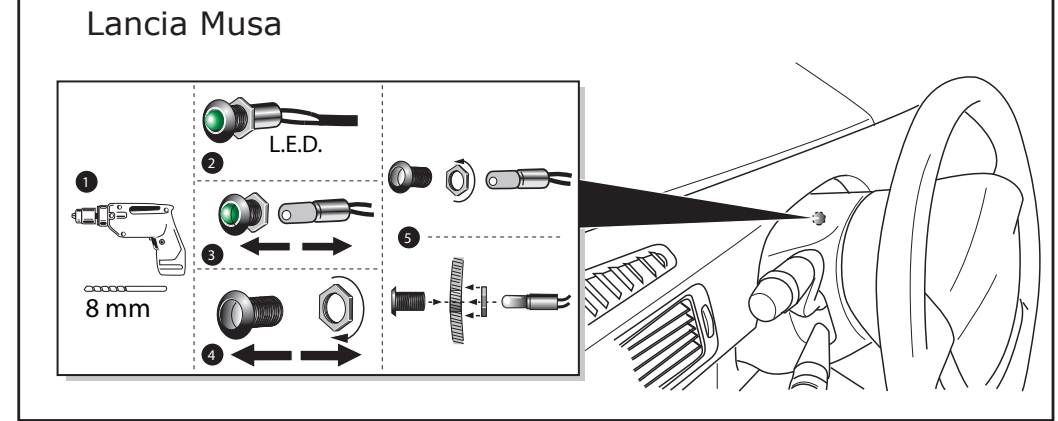
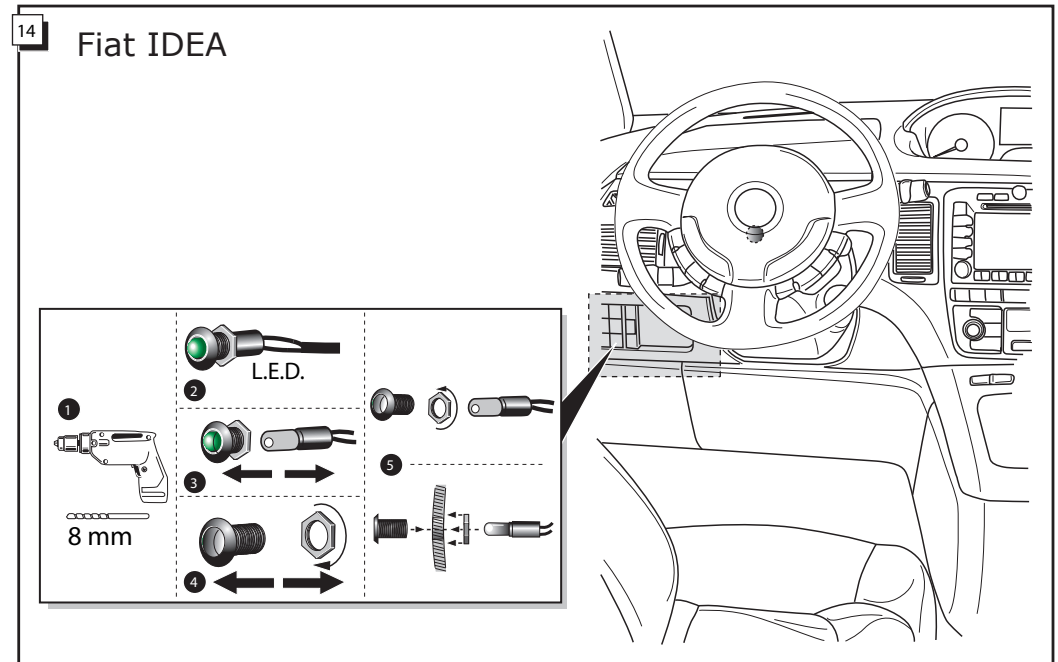
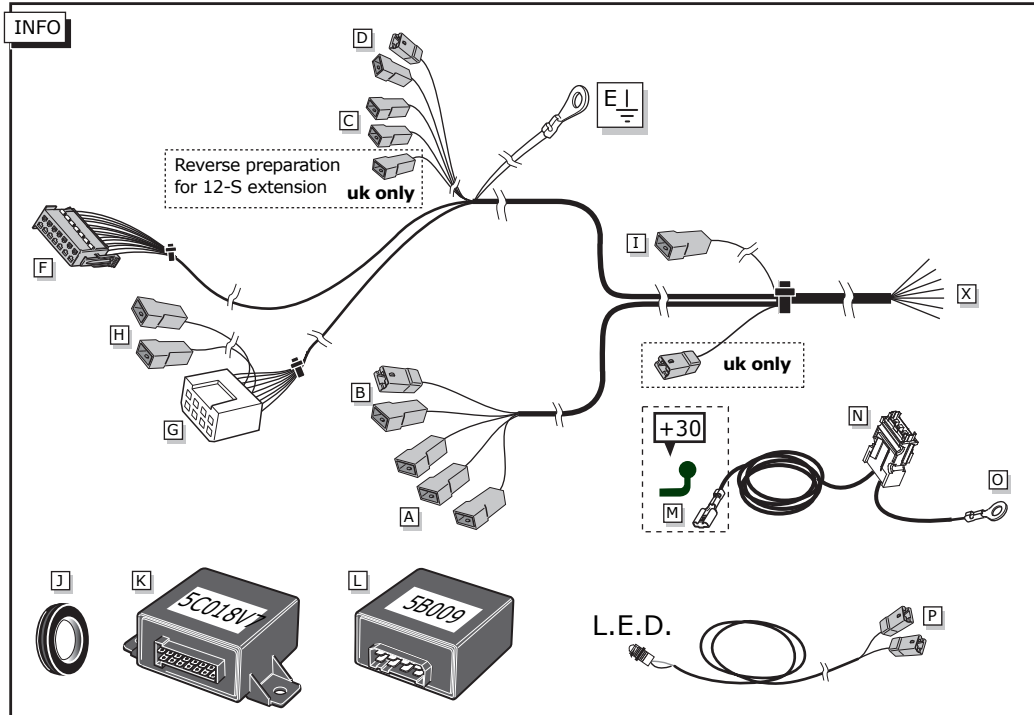
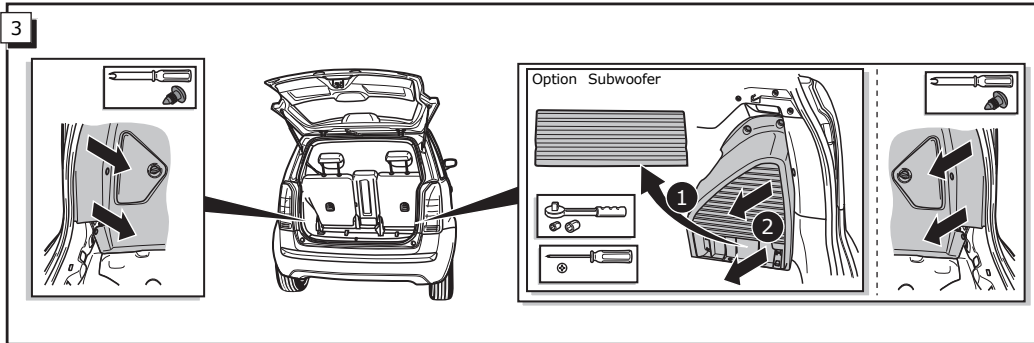
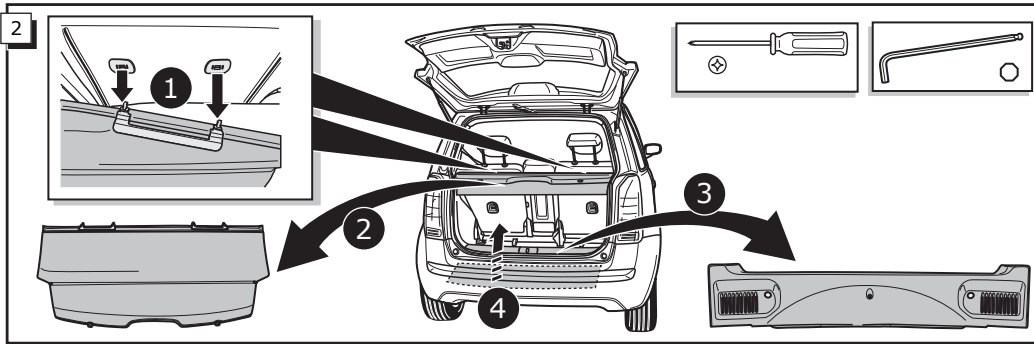

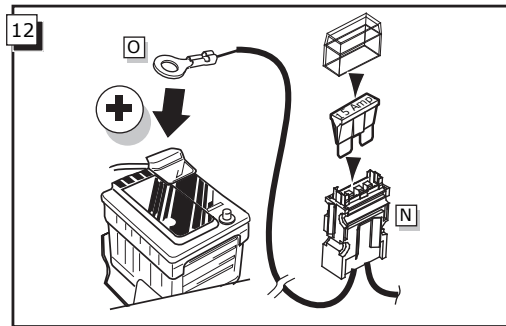
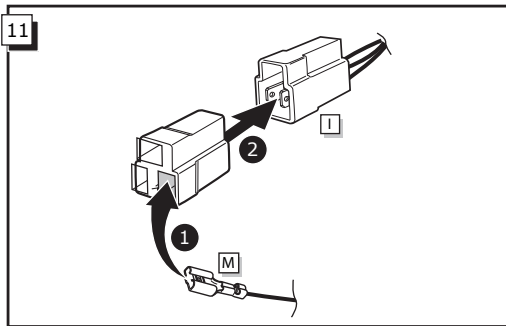
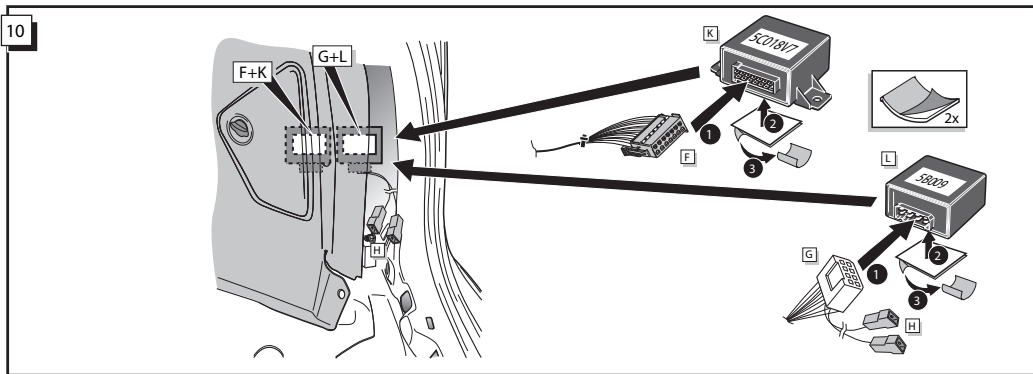
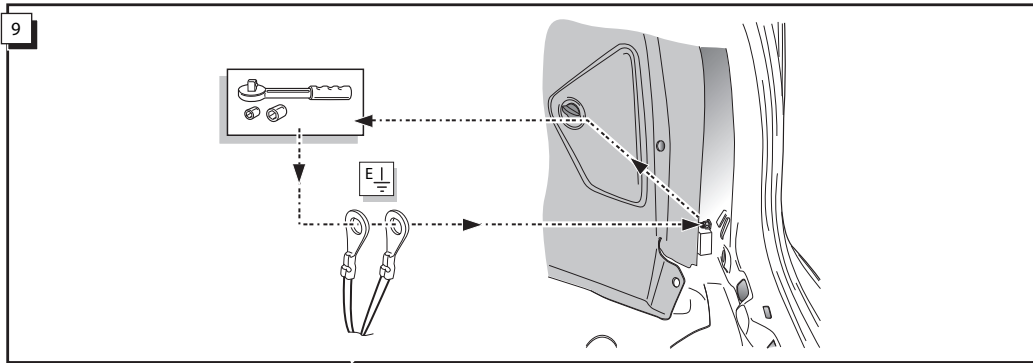

INFO

DE / AT : 13 + 14 → 16

👁️ / 🚫 / 🚫 : → 15

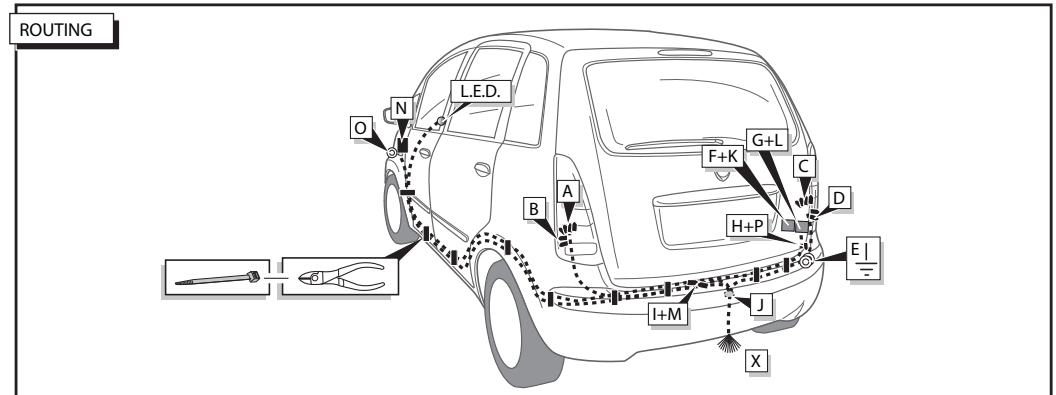
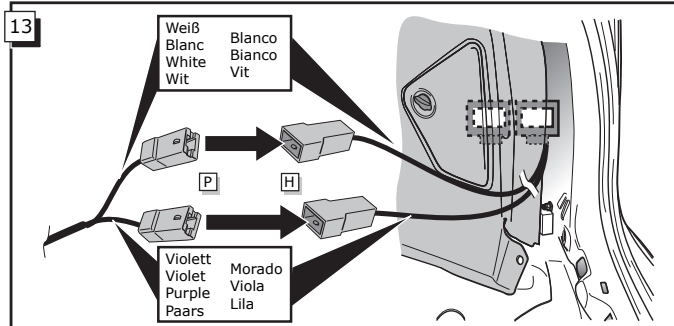

4

Fiat IDEA

Lancia Musa

5

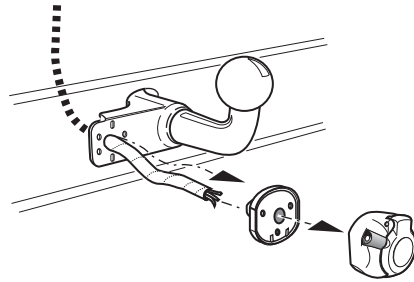

**INFO**

Anschluß Steckdose / Connection de la prise / Socket connection / Contactdoos aansluiting  
 Conexiones del enchufe / Allaccio zoccolo / Anslutning kontaktdosa

**INFO**

INFO									
DIN/ISO 1724	(DE)	(FR)	(GB)	(NL)	(ES)	(IT)	(SE)	Pmax	
←	1/L	gelb	jaune	yellow	geel	amarillo	giallo	gul	21W
⚡	2	blau	blue	blue	blauw	azul	blù	blå	2x21W
⚡ 1-8	3/31	weiß	blanc	white	wit	blanco	bianco	vit	
→	4/R	grün	vert	green	groen	verde	grön	21W	
☀	5/58-R	braun	marron	brown	bruin	marrón	marrone	brun	52W
⊘	6/54	rot	rouge	red	rood	rojo	rosso	röd	3x21W
☀	7/58-L	schwarz	noir	black	zwart	negro	nero	svart	52W

6

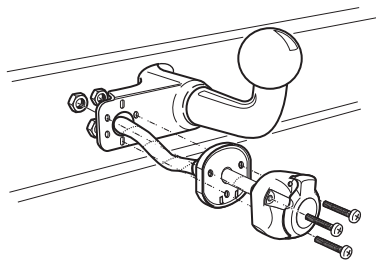

7

Kabel Kabelsatz / Fil faisceau / Wire harness / Draad kabelboom /  
 Cable haz de cables / Filo pettine del cavo / Ledare kabelbunt  
 Lokalisieren Sie und überprüfen Sie Funktionen /  
 Localisez et vérifiez les fonctions / Locate and check functions /  
 Functies doormeten / Probar funciones / Verificare le funzioni /  
 Mätning funktioner

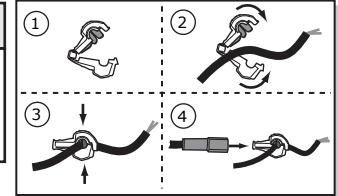

LH Y

A & Y	Schwarz/Gelb Noir/Jaune Black/Yellow Zwart/Geel Negro/Amarillo Nero/Giallo Svart/Gul	Pos. 4 ← L	Blau/Rot Bleu/Rouge Blue/Red Blauw/Rood Azul/Rojo Blu/Rosso Blå/Röd	Pos. 5 ⊘ STOP	Violett/Schwarz Violet/Noir Purple/Black Paars/Zwart Morado/Negro Viola/Nero Lila/Svart	Pos. 6 ☀ 58 L
-------	--	---------------	---	------------------	---	------------------

Y	Rosa Rose Pink Roze Rosada Rose Rose	Pos. 1 ⚡ 54G
---	--	-----------------

Y	Rosa Rose Pink Roze Rose	Pos. 1 ⚡ 54G
	Grau Gris Grey Grijs	Pos. 2 ⚡ 54G
	Gris Grigio Grå	Pos. 2 ⚡ 54G
	Rot/ Gelb Rouge/Jaune Red/Yellow Rood/Geel	Pos. 3 ⚡ 54G
	Rojo/Amarillo Rosso/Giallo Röd/Gul	Pos. 3 ⚡ 54G

8

Kabel Kabelsatz / Fil faisceau / Wire harness / Draad kabelboom /  
 Cable haz de cables / Filo pettine del cavo / Ledare kabelbunt  
 Lokalisieren Sie und überprüfen Sie Funktionen /  
 Localisez et vérifiez les fonctions / Locate and check functions /  
 Functies doormeten / Probar funciones / Verificare le funzioni /  
 Mätning funktioner

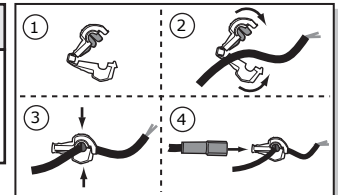

RH Z

C & Z	Schwarz/Rot Noir/Rouge Black/Red Zwart/Rood Negro/Rojo Nero/Rosso Svart/Röd	Pos. 3 ← Reverse	Schwarz/Grün Noir/Vert Black/Green Zwart/Groen Negro/Verde Nero/Verde Svart/Grön	Pos. 4 → R	Schwarz/Braun Noir/Marron Black/Brown Zwart/Bruin Negro/Marrón Nero/Marrone Svart/Brun	Pos. 6 ☀ 58 R
-------	---	---------------------	--	---------------	--	------------------

Y	Rosa Rose Pink Roze Rosada Rose Rose	Pos. 1 ⚡ 54G
---	--	-----------------

Y	Rosa Rose Pink Roze Rose	Pos. 1 ⚡ 54G
	Grau/ Weiß Gris/Blanc Grey/White Grijs/Wit	Pos. 2 ⚡ 54G
	Gris/Blanco Grigio/Bianco Grå/Vit	Pos. 2 ⚡ 54G
	Rot/ Weiß Rouge/Blanc Red/White Rood/Wit	Pos. 3 ⚡ 54G
	Rojo/Blanco Rosso/Bianco Röd/Vit	Pos. 3 ⚡ 54G