

! INFO !

- (DE) Die Batterie des Zugfahrzeugs bzw. gezogenen Fahrzeugs nicht direkt über die Steckdose aufladen.
- (FR) Ne pas charger les batteries du véhicule tracteur et/ou tracté directement sur la prise de courant.
- (NL) De accu van het trekkend voertuig c.q. getrokken voertuig niet rechtstreeks via de contactdoos opladen.
- (GB) Do not charge the battery of the towing vehicle and/or towed vehicle directly via the socket.
- (ES) No recargue la batería del vehículo remolque y/o del remolcado directamente mediante el enchufe.
- (IT) Non caricare la batteria del veicolo trainante o di quello trainato direttamente dalla presa.
- (SE) Ladda inte batteriet i det bogserande fordonet och/eller det bogserade fordonet direkt via kontakten.
- (CZ) Nenabíjajte baterii tažného ani taženého vozidla přes zásuvku.
- (DK) Oplad ikke bugseringskøretøjet og/eller det bugserede køretøjs batteri direkte v.h.a. stikdåsen.
- (FI) Älä lataa hinaavan ajoneuvon ja/tai hinattavan ajoneuvon akkuja suoraan pistorasian kautta.
- (GR) Μη φορτίζετε την μπαταρία του ρυμουλκούμενου οχήματος και/ή ρυμουλκημένου οχήματος απευθείας μέσω του ρευματοδότη.
- (NO) Batteriet til kjøretøyet som trekker eller blir trukket skal ikke lades direkte via koblingsboksen.
- (PL) Nie ładować akumulatora pojazdu holującego/holowanego bezpośrednio przez gniazdo.

- (DE) Gebrauchsanleitung
- (FR) Mode d'emploi
- (NL) Gebruikershandleiding
- (GB) User guide
- (ES) Guía del usuario
- (IT) Manuale di istruzioni
- (SE) Bruksanvisning
- (CZ) Uživatelská příručka
- (DK) Brugervejledning
- (FI) Käyttöohjeet
- (GR) Οδηγός χρήστη
- (NO) Brukerveiledning
- (PL) Instrukcja obsługi

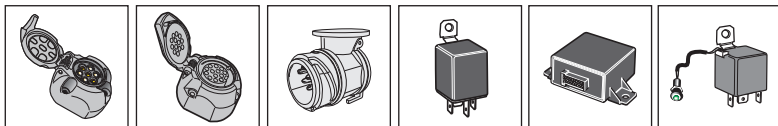
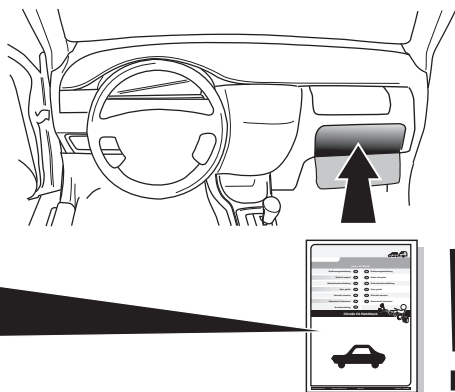

SPARE PARTS

www.ecs-electronics.com



Partnr.: KI-042-DG

Gebrauchsanleitung (DE)	(CZ) Uživatelská příručka
Mode d'emploi (FR)	(DK) Brugervejledning
Gebruikershandleiding (NL)	(FI) Käyttöohjeet
User guide (GB)	(GR) Οδηγός χρήστη
Guía del usuario (ES)	(NO) Brukerveiledning
Manuale di istruzioni (IT)	(PL) Instrukcja obsługi
Bruksanvisning (SE)	

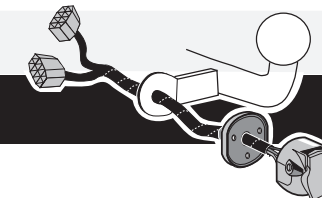

**Kia Soul 2008-
Kia Soul 2012-**

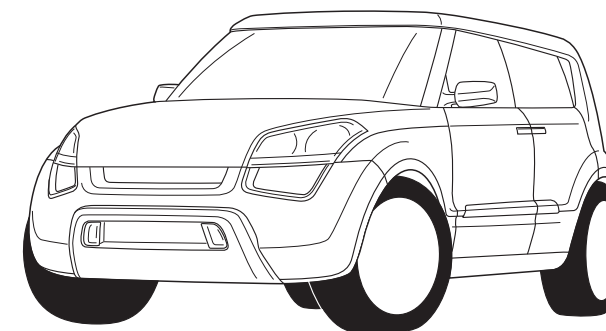

DE Anschluss Steckdose
FR Connection de la prise
NL Contactdoos aansluiting
GB Socket connection

ES Conexión de la caja de enchufe
IT Allaccio zoccolo
SE Anslutning kontaktdosa

GR Υποδοχή σύνδεσης
NO Tilkobling koblingsboks
PL Połączenie przez gniazdo

CZ Objímkový konektor
DK Stikdåse forbindelse
FI Pistorasia liitäntä

DIN/ISO 11446	←	🚗	1-8	↔	🔌	🔌	⚡	⚡	⚡	⚡	⚡	↔	↔	↔	↔	↔
Pmax	1/L 21W	2 2x21W	3/31 Weiß	4/R 21W	5/58-R 52W	6/54 3x21W	7/58-L 52W	8 2x21W	9 180W/15Amp	10 180W/15Amp	11 180W/15Amp	12	13	1	9	
DE	Gelb	Blau	Weiß	Grün	Braun	Rot (1,00mm ²)	Schwarz	Schwarz/ Rot	Braun/ Weiß	Rot (2,50mm ²)	Weiß	Rot/ Blau	Weiß	Rot/ Blau	Weiß	
FR	Jaune	Bleu	Blanc	Vert	Marron	Rouge (1,00mm ²)	Noir	Noir/ Rouge	Marron/ Blanc	Rouge (2,50mm ²)	Blanc	Rouge/ Bleu	Blanc	Rouge/ Bleu	Blanc	
NL	Geel	Blauw	Wit	Groen	Bruin	Rood (1,00mm ²)	Zwart	Zwart/ Rood	Bruin/ Wit	Rood (2,50mm ²)	Wit	Rood/ Blauw	Wit	Rood/ Blauw	Wit	
GB	Yellow	Blue	White	Green	Brown	Red (1,00mm ²)	Black	Black/ Red	Brown/ White	Red (2,50mm ²)	White	Red/ Blue	White	Red/ Blue	White	
ES	Amarillo	Azul	Blanco	Verde	Marrón	Rojos (1,00mm ²)	Negro	Negro/ Rojos	Marrón/ Blanco	Rojos (2,50mm ²)	Blanco	Rojos/ Azul	Blanco	Rojos/ Azul	Blanco	
IT	Giallo	Blu	Bianco	Verde	Marrone	Rosso (1,00mm ²)	Nero	Nero/ Rosso	Marrone/ Bianco	Rosso (2,50mm ²)	Bianco	Rosso/ Blu	Bianco	Rosso/ Blu	Bianco	
SE	Gul	Blä	Vit	Grön	Brun	Röd (1,00mm ²)	Svart	Svart/ Röd	Brun/ Vit	Röd (2,50mm ²)	Vit	Röd/ Blå	Vit	Röd/ Blå	Vit	
CZ	Žlutá	Modrá	Bílá	Zelená	Hnědá	Červená (1,00mm ²)	Černá	Černo/ Červená	Hnědo/ Bílá	Červená (2,50mm ²)	Bílá	Červená/ Modrá	Bílá	Červená/ Modrá	Bílá	
DK	Gul	Blå	Hvid	Grøn	Brun	Rød (1,00mm ²)	Sort	Sort/ Rød	Brun/ Hvid	Rød (2,50mm ²)	Hvid	Rød/ Blå	Hvid	Rød/ Blå	Hvid	
FI	Keltainen	Sininen	Valkoinen	Vihreä	Ruskea	Punainen (1,00mm ²)	Musta	Musta/ Punainen	Ruskea/ Valkoinen	Punainen (2,50mm ²)	Valkoinen	Punainen/ Sininen	Valkoinen	Punainen/ Sininen	Valkoinen	
GR	Κίτρινο	Μπλε	Λευκό	Πράσινο	Καφέ	Κόκκινο (1,00mm ²)	Μαύο	Μαύο/ Κόκκινο	Καφέ/ Λευκό	Κόκκινο (2,50mm ²)	Λευκό	Κόκκινο/ Μπλε	Λευκό	Κόκκινο/ Μπλε	Λευκό	
NO	Gul	Blå	Hvit	Grønn	Brun	Rød (1,00mm ²)	Svart	Svart/ Rød	Brun/ Hvit	Rød (2,50mm ²)	Hvit	Rød/ Blå	Hvit	Rød/ Blå	Hvit	
PL	Żółty	Niebieski	Biały	Zielony	Brazowy	Czerwony (1,00mm ²)	Czarny	Czarny/ Czerwony	Brazowy/ Biały	Czerwony (2,50mm ²)	Biały	Czerwony/ Niebieski	Czerwony/ Niebieski	Czerwony/ Niebieski	Biały	

DE Sicherungen austauschen
FR Remplacer les fusibles
NL Zekeringen vervangen
GB Changing the fuse

ES Cambio de fusible
IT Sostituire i fusibili
SE Byte av säkringar

CZ Výměna pojistky
DK Udsiftning af sikringer
FI Vaihdta varokkeet

GR Αλλαγή ασφάλειας
NO Skifte sikringene
PL Wymienić bezpieczniki

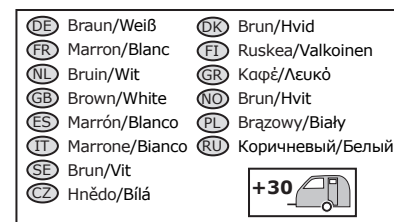
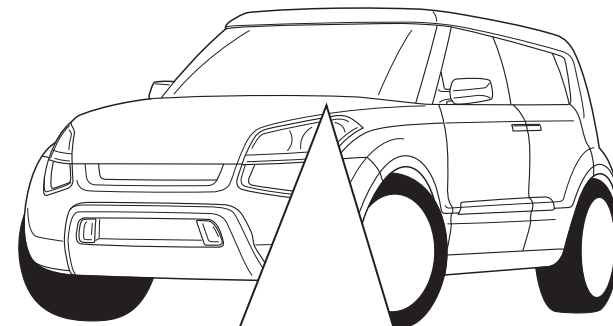

INFO : Storage

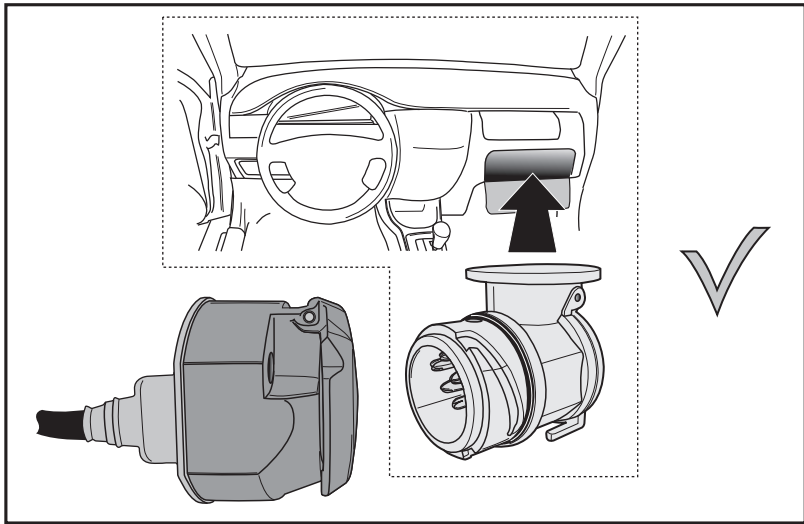
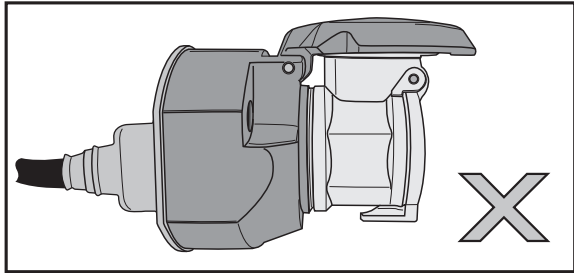
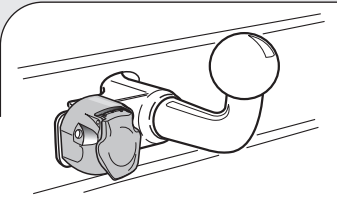
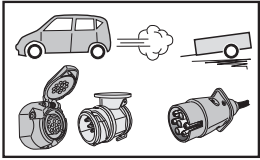

INFO

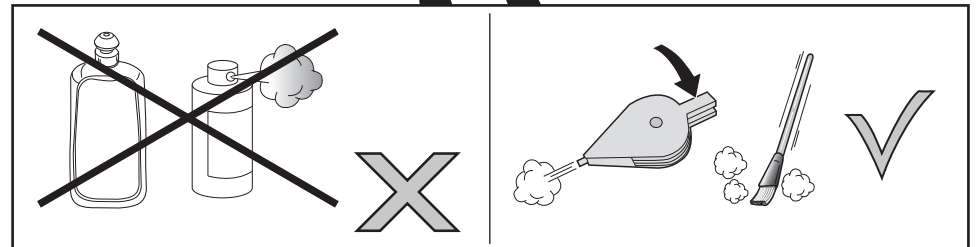
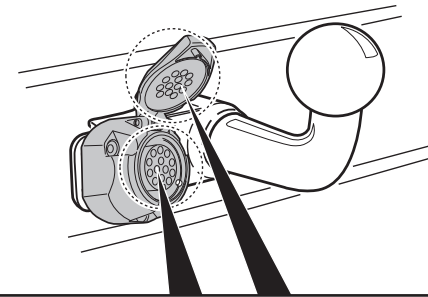
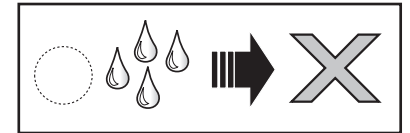
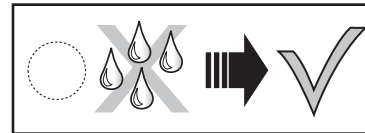
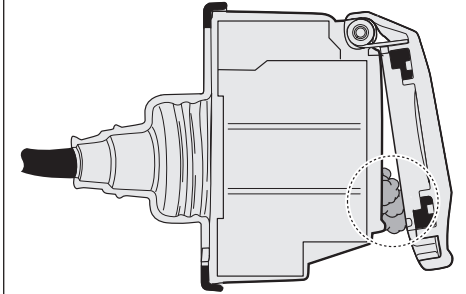
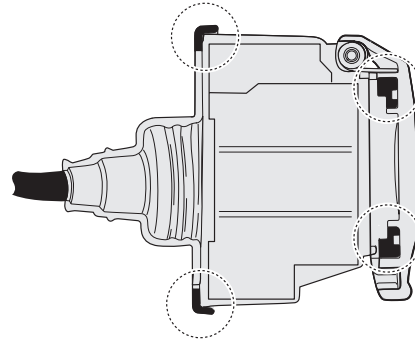
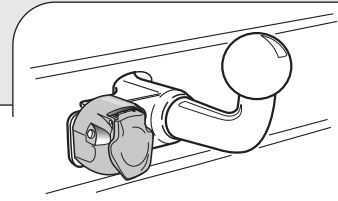
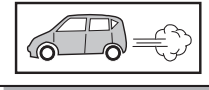

INFO : Ring.

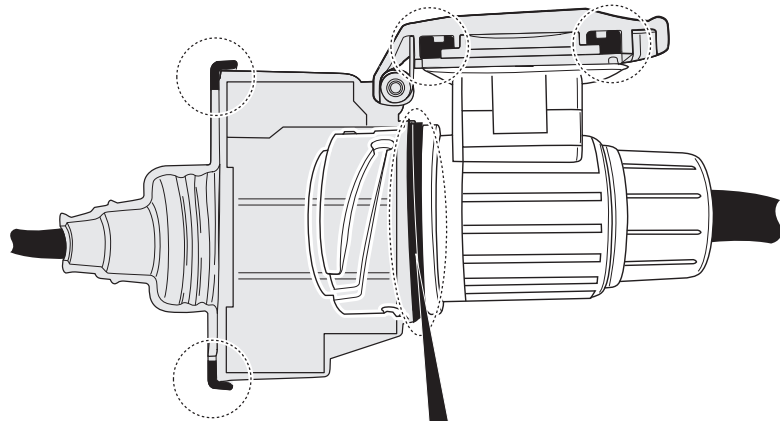
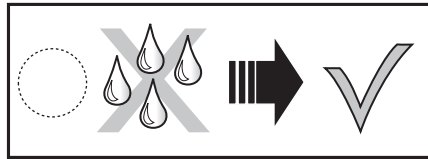
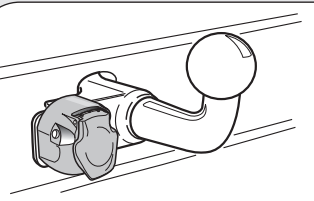
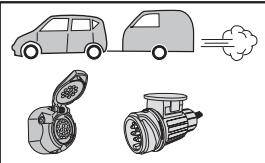

INFO

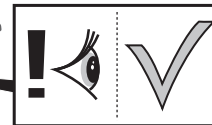
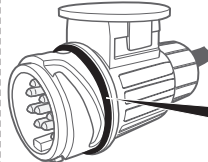
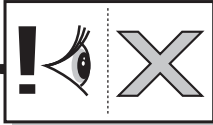
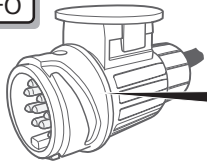

INFO : Adapt.

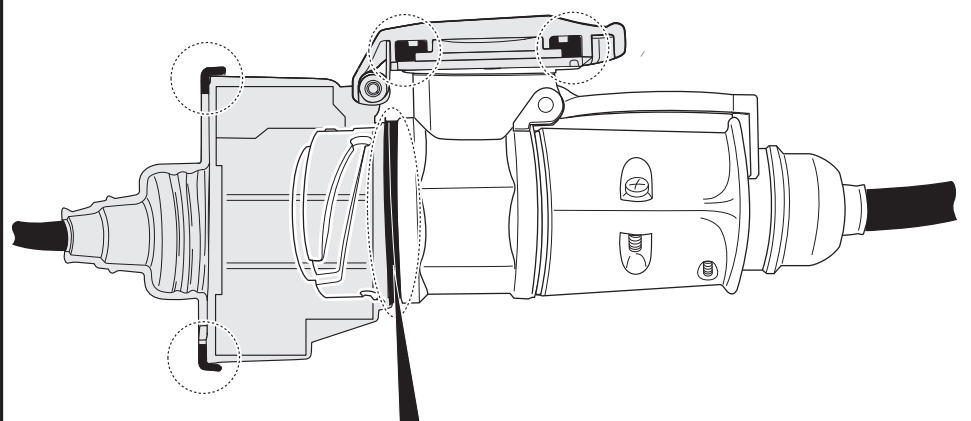
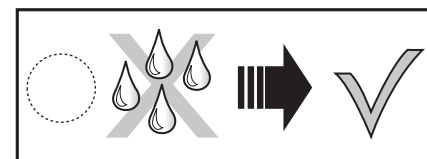
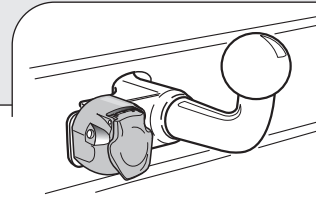
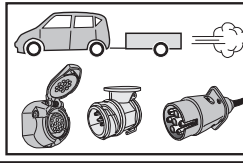

INFO

